



External lightning protection
Insulated lightning protection
Earthing material
Surge protection



Main Catalogue 2018

*Always safely
one idea ahead!*



J. Pröpster GmbH

a strong family business
– past, present and future



Humaneness & emotion

shape our thinking, our actions and our company culture. A company I like to visit, where I find more than I expected and people who listen to what I am saying.



Reliability & honesty

are our outstanding characteristics. Without fail you receive tried and tested quality. You can rely on us for honest opinions and competent promises.



Respect & trust

form the basis of our mutual high regard. With the customer in mind, we find solutions to problems and fulfil wishes quickly and effectively. Your contacts here are specialists who actively support you in achieving your goals.



Joy & enthusiasm

are both the driving force and the guarantee of success. You are held in high esteem and recognition by people who take pleasure in working towards your success. You can share this joy and experience our enthusiasm.



Our promise **"Always safely one idea ahead!"**



does not only encompass innovations and inventions, but also facilitates work processes, safety and quality at extremely stable prices with high availability.

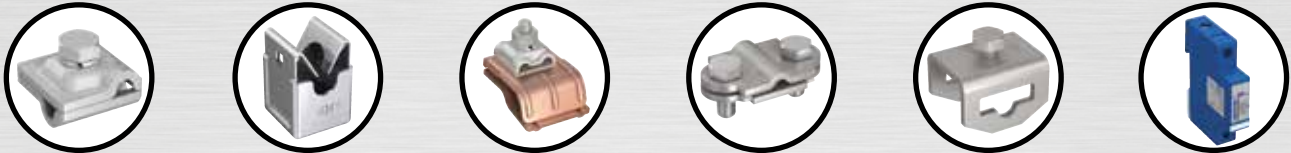

Quality is also a priority to us when offering support for projects and providing you with reasonably priced custom-built components and a perfect delivery service.

Our free winter seminars (training sessions, not sales events!) are always well-attended with great feedback.

Since our company's foundation over 35 years ago, you, the customer, have always been at the heart of our thoughts and actions.

Additional production and warehouse facilities

3 km to the south of our main site at the Federal road B8, 2 double halls with 4.000 sqm floor space were erected in the industrial area C to meet our future growth in conjunction with new developments and product improvements..



Factory I Neumarkt



Factory II Frankenberg



Factory III Deining



Inventions and innovations in lightning protection by J. Pröpster from 1980 - 2017.

According to the slogan of our company

„Always safely one idea ahead!“

with numerous inventions and innovations, we have developed lightning protection components since 1980 which were previously neither available on the market nor required by the standards. Easy mounting systems, multifunctionality, high quality standard and long life were rare up to this time.

The following examples will make you - a skilled lightning protection specialist - quickly realize the benefits of our products for yourself and your customers.

1980 Straightening device for strips

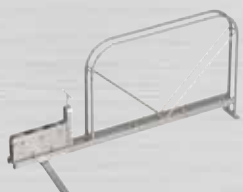

Essential for the installation of flat strips used as a foundation earth electrode or ring earth electrode.

- Benefits:**
- Uncoil, straighten and install in one step.
 - Operated by one person.
 - Time saving up to 70%.

Page 116

1981 System Multi-clamp

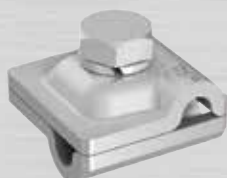

The **original Multi-clamp** was invented by J. Pröpster in 1981, millions of which have been installed worldwide ever since. It is the most varied lightning protection component and the centerpiece of the multifunctional system of J. Pröpster. Huge benefits for planning, storage, installation, calculation, installation time and price.



T-connection cross-connection parallel-connection end to end connection stem clamp trestle Multi-Plus as terminal clamp

Page 69

1982 System USV-clamp



Easy-to-assemble connection system e.g. for earth conductors in concrete. Universal connection clamp for flat and round conductors e.g. 30 x 3.5 mm / ø 10 mm.

- Benefit:**
- Considerably shorter and easier installation in high quality.



flat/flat connection flat/flat T-connection flat/round parallel connection flat/flat connection and round T connection flat/flat/round cross connection

Page 94

Systematic introduction of aluminium alloy components



AlMgSi 0.5 as lightning protection down conductor ø 8 mm with appropriate clamps and holders made of aluminium and screws made of stainless steel.

- Benefits:**
- High electric conductivity.
 - Low transport weight (0.135 kg/m; weight per ring 15-20 kg).
 - Good mechanical strength (150 - 160 N/mm²).
 - Good resistance to corrosion.
 - Easy and fast installation.

Page 33

1982



Introduction of stainless steel wires and strips

made of 1.4301 (stainless steel V2A) and 1.4571 (stainless steel V4A) for earth termination systems instead of lead coated material.



Page 32-33



Invention of a complete product series made of stainless steel: Clamps, pipe clamps and holders for lightning protection and earth termination systems

SK - conductor fastener

made of aluminium and copper-alloy for a decorative appearance.



Page 46

1983

System Multi Plus (J.P. patent)

A further development of the original Multi-clamp, with an additional large contact surface (10 cm²) for all wire connections and also as a metal sheet terminal clamp.



Page 68

System Bimetal (J.P. patent)

The ideal system -standard conform- for all connections and terminals between different materials.

Benefit: • Non-corrosive connections between copper conductors and components made of a different material e.g. aluminium or hot-galvanized steel for earth lead-in rods, test joints, skylights and metal constructions.



Page 82-83

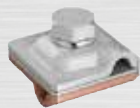

Multi clamp



Vario-clamp



Gutter connection clamp



Saddle clamp

System Vario-clamp

The **original system Vario-clamp** is a practical solution for the connection of differently shaped conductors. All components are manufactured using stamping technology and are inter-changeable.



Page 76



ø 8-10/8-10 mm



ø 8-10/16 mm



ø 8-10/30x3.5 mm
ø 8-10/40x4 mm



30x3.5/30x3.5 mm
40x4/40x4 mm



1984 System Diagonal-cross clamp



Page 94

The easy-to-assemble connection system for earth conductors flat/round.

- Benefits:**
- Shorter and easier installation.
 - Two screws M10 with anti-turn device.



System Niro-Clip (J.P. patent)



Page 44 ff.

The **Niro-Clip** conductor fastener - made of 100% stainless steel - used as a roof and wall conductor fastener.

- Benefits:**
- Maximum mechanical strength.
 - 100% weather resistant.
 - Easy to use: Simply push in the wire and it is secured as if it were screwed.
 - Available as fixed or loose conductor leading.



Trapezoidal support - 100% stainless steel



Page 54 ff.

For running conductor lengthwise and crosswise, stability due to trapezoidal double support and embossing.

Earth lead in rods with terminal lug - insulated



Page 92

Welded connection from \varnothing 16 mm to \varnothing 10 mm, hot galvanized and additionally protected against corrosion by a shrink-on tube in the dry/wet area of earth entry.

- Benefits:**
- Significantly time saving and easier installation.
 - Direct connection to the ring earth electrode.
 - No inconvenient screwing, welding and winding on the building wall
 - The terminals can be easily bent into shape.
 - No need for a connection in areas with a high risk of corrosion.

Fixed earthing terminals with different connections



Page 103

- Benefit:**
- Completely safe, corrosion resistant earthing terminal - large contact plate \varnothing 80 mm made of stainless steel.

1985 Universal downpipe clamp



Page 88

For cutting as required – incl. 7 pre-cuttings \varnothing 9 mm and markings - only 2 downspout clips are sufficient for all common downpipes.

- Benefits:**
- Space-saving storage.
 - Universal usage.

Wedge connector with catch



Page 100

For the connection of earth conductors flat/flat and flat/round in concrete. Installation note: Wedge has to be installed crosswise to the top conductor.



1986

Duo-Gutter clamp (J+P patent)



- Benefits:**
- Large contact surface.
 - Only 1 screw M10.
 - With double terminal clamp - also conductor connection possible.
 - Significantly shorter and easier installation.

Page 73

1987

Straightening device for round wires and strips

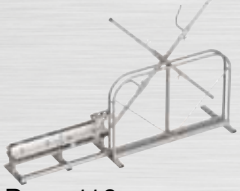

- Benefit:**
- Levelling rolls easily adjustable, for use with wires with different degrees of hardness

Page 116

1988

Roof conductor holder (J+P patent)



- Benefits:**
- Brilliant simplicity.
 - Stable due to trapezoidal shape with double support.
 - No screw.
 - No plastic; entirely made of stainless steel.
 - Quick and easy installation.

Page 54

1989

PRÖ COLOR

Coated lightning protection components in different colours for a more decorative look.

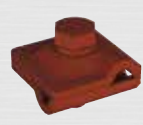

Page 63-65

1990

Complete programme of earthing busbars and equipotential bonding bars



For industrial use and power supply.

Page 113 f.

1991

Öko 1-Roof conductor holder for flat roofs

With frostproof natural stone filling, easy to recycle, without concrete.



Page 61

Parallel and cross-terminal clamp

Ideal for the connection of a fixed earthing terminal to the reinforcement.



- Benefits:** Installation is possible in just 2 steps, because of 2 threaded bolts M10x60 mm in the middle plate:

1. Connect the foundation earth electrode to the reinforcement and
2. Connect and fix the fixed earthing terminal to the reinforcement - parallel and cross connection possible!

Page 108

1992

Öko 2-Roof conductor holder for flat roofs (J+P patent)

Pressed concrete block - 100% recyclable
The conductor holder can be fixed onto synthetic roofing membranes with securing strips.



Page 61



1993

Air termination rod as system component for the insulated lightning protection.

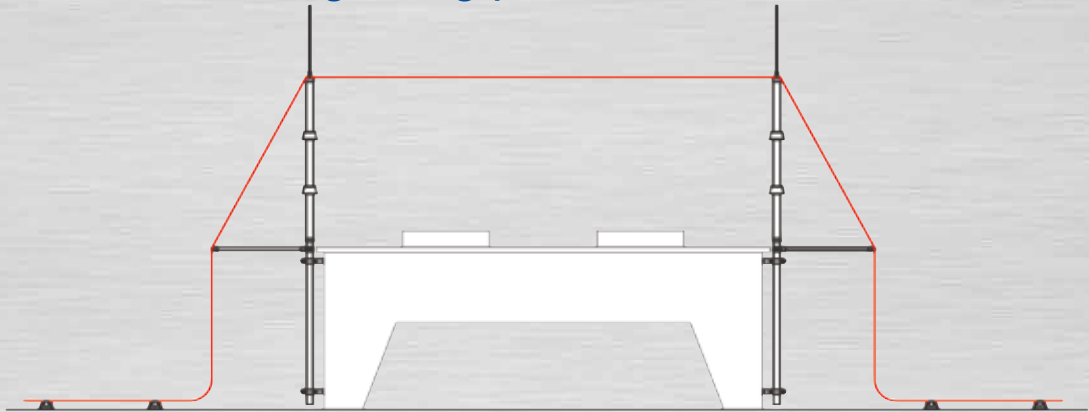

Page 122-129

Roof conductor holder-universal (J.P. utility patent)

- Benefits:**
- Attractive appearance.
 - Suitable for all sizes of tiles.
 - Conductor holder universally adjustable.



1994

DIN ISO 9001 certification

Certification of factory I Neumarkt and factory II Frankenberg/SN according to DIN ISO 9001 by the DQS and also EN 29000 for 16 European countries.

1995

Metal sheets terminal clamp (J.P. utility patent)

Designed for damage-free and lightning-current bearing connection to different types of sheets, in particular thin sheets or soft connecting materials.



Page 78

1996

Optimal air termination rod \varnothing 16 mm / \varnothing 10 mm

- Benefits:**
- Proven successful a million times.
 - Attractive appearance - optimal static design.
 - Ideal coordination of protective effect and materials input.
 - Minimum surface area exposed to the wind and maximum protection.
 - Reduced load pressure on roof covering and insulation.



Page 34

1998

ISO-Fugal - down conductor wire \varnothing 8 mm

With halogen-free plastic coating.

- Benefit:**
- Time saving due to easier and faster processing compared with \varnothing 8 mm steel wire with pvc-coat and also better conductivity.



Page 33

1998

Lightning current arrester P-BM, type 1 (JIP patent)



- Benefits:**
- On spark gap basis, smallest encapsulated type 1 arrester (35 kA) in the world, to protect electrical installations against direct lightning current.
 - High energy, encapsulated, non-exhausting spark gap.
 - Test according to standard in certified testing institutes with current pulses of the high-energy curve shape 10/350 μ s.
 - Multipole specification, dimensioned for a maximal lightning current of 100 kA in all mains systems.

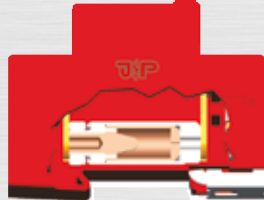

Page 158

1999

Test badge for lightning protection system



For disconnection clamps and conductor holders, for the regular documentation of tests.

Page 86

2000

Niro-Clip with loose conductor leading (JIP patent)



Benefits:

- The lightning conductor remains straight despite the temperature-related longitudinal adjustment.

Page 44 ff.

2001

Saddle clamp (JIP utility patent)



For secure connection to metal sheets and steel constructions.

Page 78

2002

Öko 3-Roof conductor holder for flat roofs (JIP patent) with stainless steel clip



- Benefits:**
- High quality: Stainless steel clip with loose conductor leading.
 - Specification: Compressed concrete block (weight: 1.2 kg).
 - No frost-sensitive cavities and recesses - totally frost-proof and 100% recyclable.

Page 61

Roof conductor holder with tension springs (JIP patent)

Universally useable for ridge tiles.



Page 59

2003

Earthing kits for lightning protection systems and railway, bridge and tunnel constructions which are approved by the federal railway authority EBA.



Page 109-110

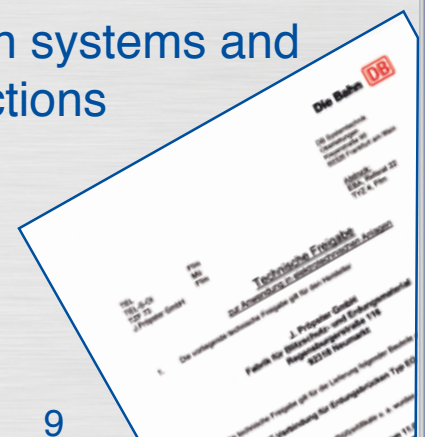



2003

Combined lightning current and surge arrester P-HMS type 1+2 (class I+II)



- Benefits:**
- Reasonable and practical lightning current and surge arrester for internal lightning protection.
 - High energy varistor technology for the highest surge withstand.
 - Use as a combined lightning current and surge arrester type 1+2.
 - No danger of follow currents due to arrester with varistor technology.
 - The surge protective device does not only responds to lightning currents, but also to switching surges according to the varistor characteristics.

Page 161 ff.



Fixed earthing terminal system (J.P. patent)

- Benefits:**
- Easy installation with flexible connections, flat and round.
 - Non-corrosive connection with stainless steel external contact.
 - Also suitable as test joint.



Terminal clamp, heavy-duty type (J.P. patent)

- Benefits:**
- Contact stable connections to steel structures with max. 52 mm clamping range.
 - Variable connections through rotating terminal lugs (360°).
 - Connection with KS-Clamp, Vario-clamp or punched strip possible.
 - Ex area (zone 2/22): The clamp (DIN EN 63305-3 Bbl. 2) is protected against self-loosening.

Page 81

2004

Roof conductor holder for Kal-Zip-roofs (J.P. patent)

The reasonably priced solution for fixing conductors to round seams.



Page 57



Clamps and pipe clamps for safe (J.P. patent) connections in hazardous areas

Not yet fully realized because of lack of test specification.



Screwless tape conductor holder (J.P. patent)

The reasonably priced and practical solution for fixing of 30 mm flat strips.

Benefit: Less work - insert the strip, bend the lug - ready.

Page 51



JP-MBF lightning protection system (J.P. utility patent) for antennas and roof installations

ISO air termination system for complex roof installations

- Benefits:**
- Reduces the separation distance "s".
 - Standardized (down conductor 50 mm²).
 - Optically unobtrusive.
 - Cut to the right length on site.
 - Installation is necessary only in the area where the separation distance is not kept.
 - Easy-to-assemble.
 - Insulated specification.
 - Reasonably priced solution.

Page 138





2005

Concrete base with J.Pröpster wedge technology

(J&P patent)

- Benefits:**
- Fit of the air termination rod adjustable to the roof.
 - High quality: wedge + clamp completely of stainless steel V2A.
 - Wedge with integrated double connection clamp

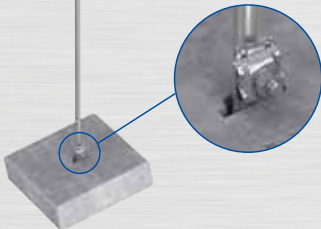

Roof pitch compensation:



Page 36

Telescopic insulated stand-off with tape clamp



- Benefits:**
- Infinitely adjustable.
 - Heavy-duty specification (GRP \varnothing 40/32 mm).
 - For free carrying of air termination rods.

Page 124

Surge arrester for photovoltaic systems with integrated decoupling coil



- Benefits:**
- Specially designed for the use in the DC side of photovoltaic systems .
 - Fault resistant Y circuit.
 - Energetic coordination to a surge protective device integrated in the inverter without additional conductor length.

2006

Touch voltages protection measures for lightning protection systems

For protection against dangerous touch voltages, also with integrated disconnecting clamp.



Page 139

J.Pröpster CC Clamp system

For terminals and connections \varnothing 8-10 / \varnothing 16 mm with clamps, pipe clamps or steel constructions.

- Benefits:**
- Clamping system for round conductors \varnothing 8-10 / \varnothing 16 mm.
 - Variable fixing lengths by easy swap of the hexagonal bolt M10.
 - Ex area (zone 2/22): The clamp (DIN EN 63305-3 Bbl. 2) is protected against self-loosening.
 - - 100 kA tested -

Type A

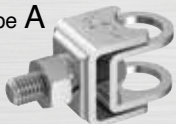

Type B



Page 70

Type C



Page 75

Type A: Connection of air termination rods or earth lead-in rods \varnothing 16 mm to clamps, pipe clamps or steel constructions.

Type B: Connection of rods \varnothing 16 mm and conductors \varnothing 8-10 mm to clamps, pipe clamps or steel constructions.

Type C: Connection and disconnection clamp \varnothing 8-10 / \varnothing 16 mm - also suitable for cable connections.



2007

Roof conductor holder for RIB-Roof 500 System (J&P patent)

The reasonably priced solution for installing round conductors to RIB-Roof 500 system.



Page 57

Connection clamp for earth rods

Connection of strips 30 x 3.5 mm, round conductors \varnothing 10 mm and earth rods \varnothing 25 mm.



Page 101

2008

Connection clamp (J&P utility patent)

For different combinations \varnothing 6-20 mm and flat 30 x 3.5 mm or \varnothing 10 mm; with M10 clamping screw.

- Benefits:**
- Maximum contact security through consistent contact pressure.
 - Shorter and easier installation - only 1 screw M10.
 - Universal usage and lightning current carrying capable connection - reinforcement irons and earthing conductors are positioned in the part by the guide beading and are connected with just one clamping screw.



Page 99

fl. 30 x 3.5 / \varnothing 10 mm

\varnothing 16 / \varnothing 10 mm

\varnothing 16 / fl. 30 x 3.5 mm

fl. 30 x 3.5 / fl. 30 x 3.5 mm

fl. 30 x 3.5 / \varnothing 10 mm

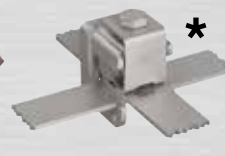
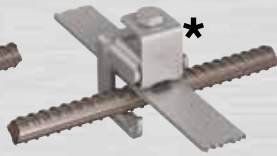

* Connection also possible without clamping bracket.

2009

Air termination rod system for all common types of roof tiles.

Infinitely adjustable, to fit any tile

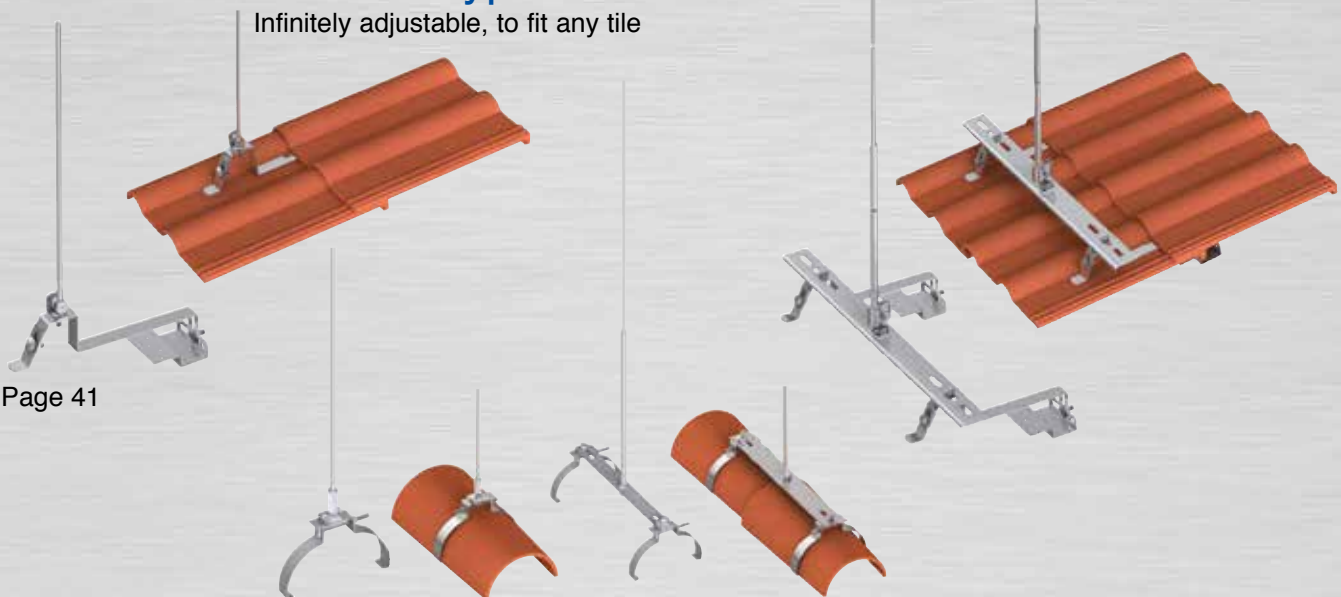

Page 41



2009 Clamping piece



Suitable for the use of round conductors \varnothing 10 mm as spacers for the installation of foundation earth electrodes flat 30 x 3.5 mm on end or round \varnothing 10 mm.

Benefit: • Infinitely adjustable height for different foundations (soil, sand, mineral concrete) or blinding layer.

Distance pins have to be installed by the customer.

Page 93

Distance pin:
reinforcement iron \varnothing 10 mm
or wire \varnothing 10 mm

Blinding layer
of concrete



Strip 30 x 3.5 mm or
round wire \varnothing 10 mm

Fixing system for insulated stand-offs **16plus+**

Light-weight type for the fixation of air termination rods with additional concrete base.



Page 126-128

Individual combinations:

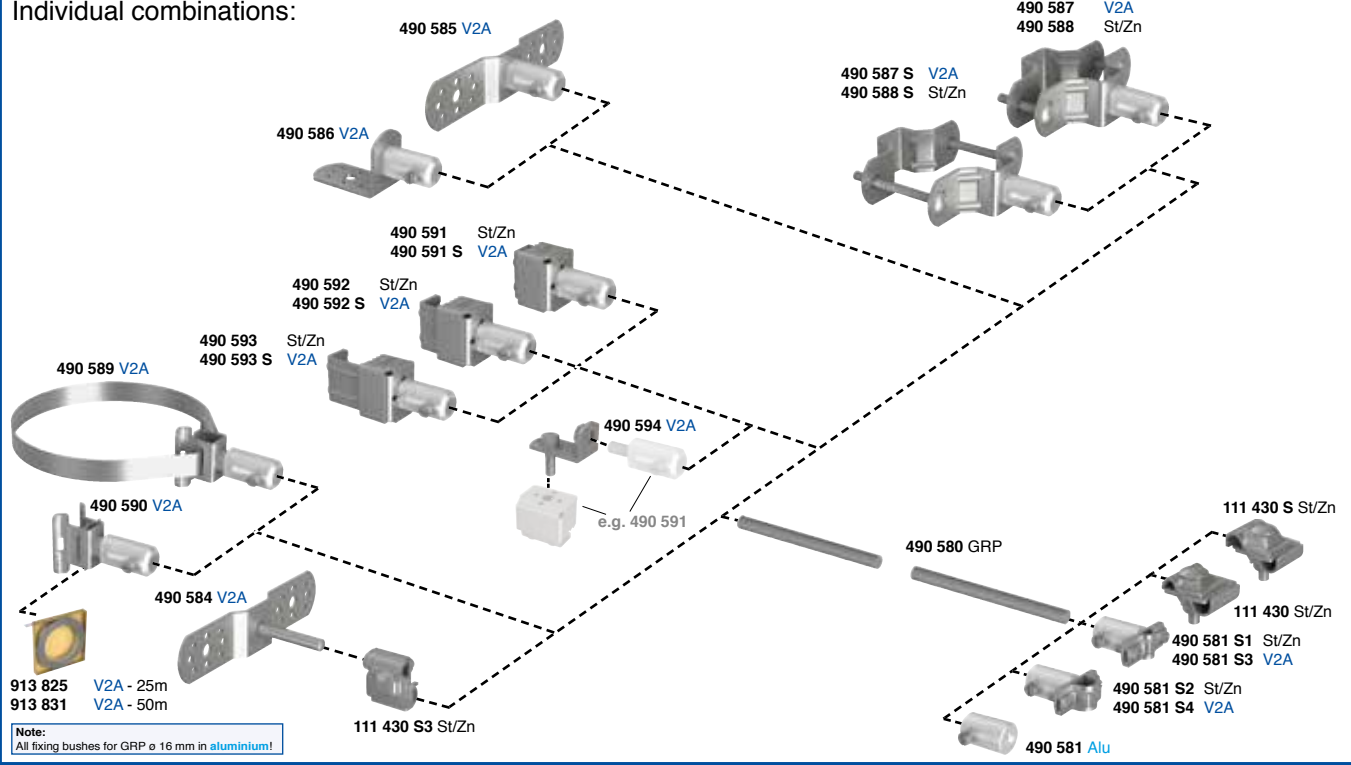



2010 Air termination rod system (J.P. utility patent) for metal / tin roofs

with magnetic plate (also for a roof pitch up to 10°).

Air termination rod system with fixing cross, base with magnetic plate and KS-connector.

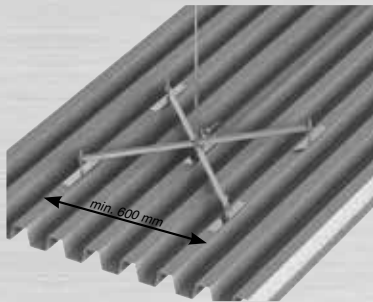

Page 39

2011 Conductor fastener for metal / tin roofs

Made of stainless steel V2A with magnetic plate and Niro-Clip V2A for ø 8 mm loose conductor leading inclusive plate V2A 180x40x3 mm, or type with spacer to raise the height of the conductor leading to 80 mm.

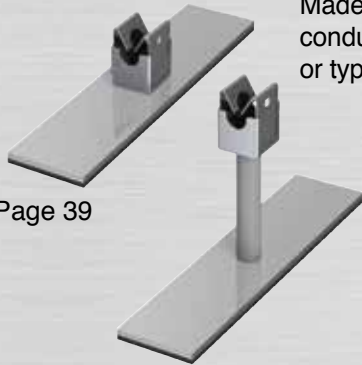

Page 39

A change of colour for all our surge protection devices from red to blue, our company colour.

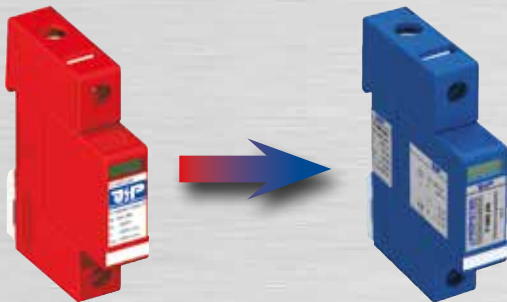

Prö Cu/Al-wire - round wire made of bimetal-composite Cu/Al

The aluminium core is crimped with the copper coating. In this way both materials are bonded together to be non-corrosive.

- Benefits:**
- Cost saving - good price-performance ratio.
 - Lower price fluctuation due to less copper content.
 - Torsionable - can be worked like soft wires.
 - Non-corrosive connection between aluminium and copper.
 - No problems with corrosion at the cut surface, because of the surface ratio of copper and aluminium.
 - In conformance with standards.



Seite 33



2012

Niro-Clip conductor fastener - high version



Height of conductor leading: 36 mm.
Conductor fastener for fixing round conductors to roofs and walls.
Snap mechanism and base made of metal.



Page 44 ff.

System Vario-clamp - M8-Plus (J+P patent) with cylindrical collar



The **system Vario-clamp M8-Plus** is a reasonably priced, practical solution for connecting differently shaped conductors.

Benefit: • The cylindrical, patented collar on the top part, considerably improves assembly.



ø 8-10/8-10 mm



ø 8-10/16 mm



ø 8-10/30x3.5 mm
ø 8-10/40x4 mm



30x3.5/30x3.5 mm
40x4/40x4 mm



System Bimetal
ø 8-10/30x3.5 mm

Page 77

Surge protective devices - mains systems type 1+2 and type 2

- Benefits:**
- Safe plug-in fixation and contacting due to module locking mechanism.
 - **P-HMS 280 R** with 12.5 kA (10/350 μ s) per pole and 50 kA (10/350 μ s) 4-pole.
 - **P-HMS 280 max** with 25 kA (10/350 μ s) per pole and 100 kA (10/350 μ s) 4-pole.
 - Optimum price-performance ratio.
 - High backup fuse values.



P-HMS 280 Fm *max*



P-HMS 280 Fm R 4



P-HMS 280 *max* 3+1



P-HMS 280 R 3

Page 160 /162 / 164

Surge protective devices - photovoltaic systems type 1+2 and type 2

- Benefits:**
- Safe plug-in fixation and contacting due to module locking mechanism.
 - Type 1+2 with 12.5 kA (10/350 μ s) per pole.
 - Optimal price-performance ratio.



P-HYS 605 Fm R PV



P-VYS 605 Fm R PV



P-HYS 805 R PV



P-VYS 1005 R PV

Page 168 f.



2013 Fixed earthing terminal with foam cover

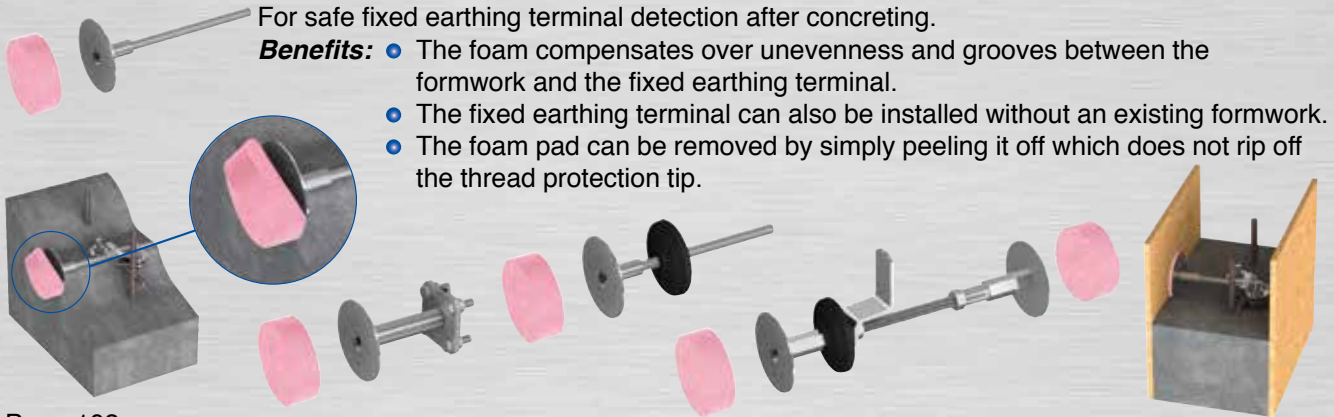

For safe fixed earthing terminal detection after concreting.

- Benefits:**
- The foam compensates over unevenness and grooves between the formwork and the fixed earthing terminal.
 - The fixed earthing terminal can also be installed without an existing formwork.
 - The foam pad can be removed by simply peeling it off which does not rip off the thread protection tip.

Page 103

Protective cap for earthing conductors



For injury prevention and for marking during the construction stage.

- Benefits:**
- Distinct marking of the earth lead-in terminal lug during the construction stage (requirement according to DIN 18014).
 - Injury prevention.
 - For \varnothing 10 mm or flat 30 x 3.5 mm.
 - Easy and fast fitting on conductor ends.
 - Cost-effectivel, reusable, safe.

Page 93

k_C -clamp (J.P. patent)



Connection-clamp to reduce the kc value to the factor 0.25 by splitting up the lightning current flowing through the air-termination rod amongst down conductors.

- Benefits:**
- All connection types (cross-, T-, corner-, parallel-, end to end connection) and additional connection to an air-termination rod or tip with only one clamp are possible.
 - A connection for crossing points of the conductor routing with an air-termination tip is also possible without a concrete base.
 - The kc-clamp easily reduces the kc value by a factor 0.25 by splitting up the lightning current flow.
 - The kc-clamp is also useable in already installed systems.

Page 37

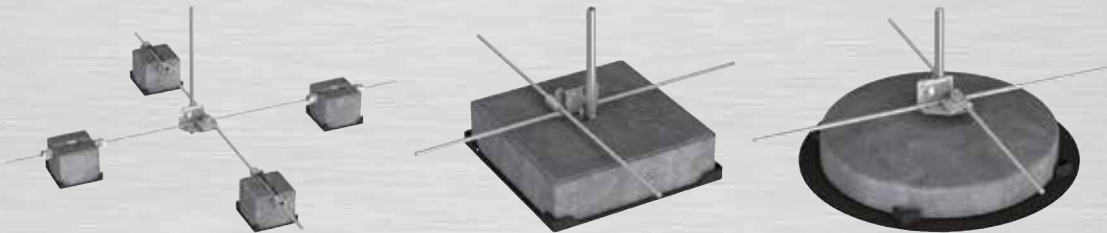

Support tool for concrete base with wedge

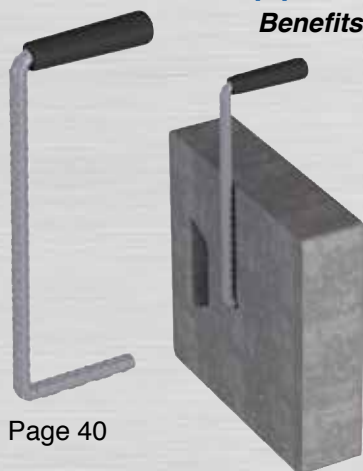

- Benefits:**
- Even ergonomic weight shift.
 - Easy and quick placement of the concrete bases – reduction of undesired motion processes which may cause back, shoulder or neck problems.
 - No abraded finger skin or work gloves.
 - Comfortable transportation with soft carry handles, also suitable for longer distances.

Page 40





Quick connectors



To connect reinforcements and round conductors \varnothing 6-10 mm / \varnothing 10 mm

- Benefits:**
- Easy and simple installation – only one clamp bolt M10.
 - T-, joint, cross and parallel connections possible.
 - Easy handling of parallel connections along the line run due to fixed guide lugs.

Page 98

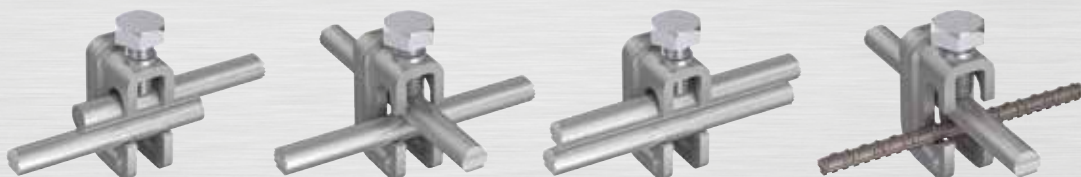

Protection measures against step voltages

e.g. in shelters by means of interlinked grid bar mats. According to German VDE/ABB brochure „Blitzschutz von Schutzhütten“.

- Benefits:**
- Potential control with mesh size of grid bar mats 250 mm x 250 mm.
 - Grid bar diameter: 4mm.
 - Manufactured completely of stainless steel V4

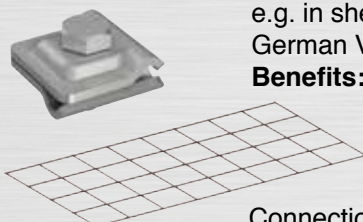

Connection example:

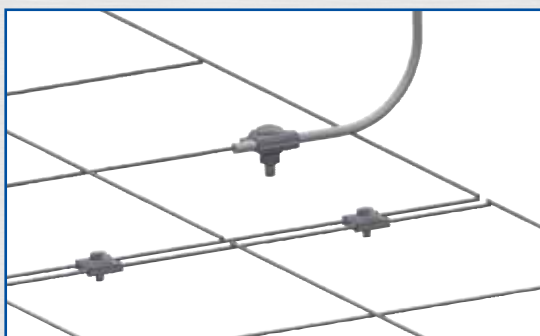

Page 93

2014 ES reinforcement clamp



to connect flat and round conductors to the reinforcement steel

- Benefits:**
- Just one screw M10.
 - Longitudinal, cross and diagonal connections are possible.
 - The clamping area can be changed by simply rehanging the clamp bottom part to the top part.

Page 100



Parallel saddle clamp



special clamp to install the conductor alongside the joint, snow load protected. Clamping range up to 4 mm.

- Benefits:**
- Simple and quick installation.
 - Secure clamp positioning on the joint.
 - Significantly better installation by patented cylindrical attachment.

Page 80





2014

Multi-flat/round connecting clamp

for a fast and simple connection of tapes with the reinforcement

- Benefits:**
- No loose components during the installation.
 - Low construction height after the installation.
 - All occurring connection types are possible such as T-, cross, parallel and diagonal connection.
 - Different cross sections can be used, e.g. flat 30x3.5 mm und \varnothing 5 - 25 mm.
 - Only one screw M10 = central contact pressure.
 - Optimal economic use for planning, storekeeping, calculation and invoicing.



Page 96



round/flat
cross connection



round/flat
diagonal connection



round/flat + round
parallel connection



round/flat + round
cross connection

Connection set for safety rope systems

to connect safety rope system on roofs with the lightning protection system.

- Benefits:**
- No negative impact of the PSA rope glider when passing the rope contacts.
 - Length compensation between the lightning protection system and the rope protection system in case of fall loads.
 - Lightning current protected connection to the existing external lightning protection system.



Page 40

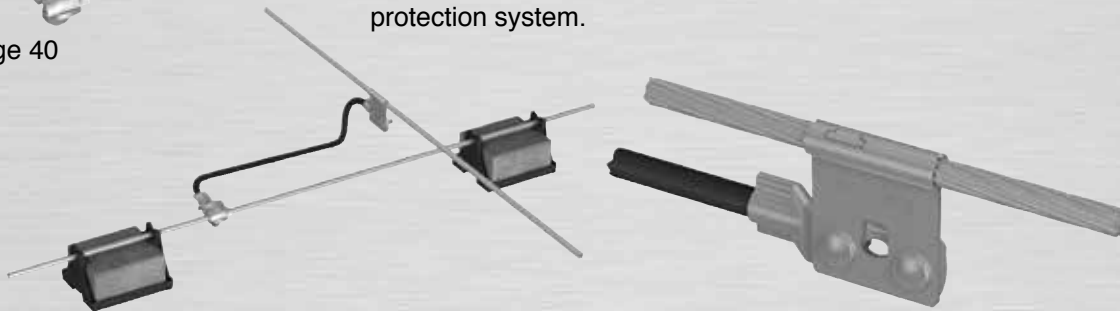

Connection clamp

for fast and simple connection of grounders to the reinforcement.

- Benefits:**
- Easier installation than with conventional diagonal clamps due to swivelling opening in the top of the clamp.
 - No clamp dismantling necessary.
 - Large clamping range flat/round (\varnothing 10 / fl. 40 mm) compatible with the reinforcement (\varnothing 6 - 40 mm).
 - T-, cross, parallel, and diagonal connections are possible.



Page 95





2014

Disconnection clamp with terminal angle

Two versions, for clamps \varnothing 8-10 mm or flat 30 mm

- Benefits:**
- Optimized tight fit with the open-end wrench due to the patented cylindrical part of the Vario-clamp top part.
 - Universal use e.g. installation with a connecting terminal to a T-carrier or direct installation on a fixed earthing terminal.
 - Cost-efficient solution – terminal angle and disconnection point in one component.



Page 75



Factory expansion (45,000 sqm) in Deining



Three kilometres to the south of the main factory, the new warehouse is built with 4.000 sqm on a site of 45,000 sqm.



2015

Equipotential bonding bar with metal cover

(J.P. utility patent)

Benefits: • Each clamping screw is protected against self-loosening through a spring ring (according to EN 60079-14).

- Connection is possible from the top and the bottom.
- Clamps cannot be lost the way they are installed and can be individually removed.
- Break-proof aluminium cover - sealable.
- Low construction height.
- Clearly marking of the individual clamping positions on the busbar.
- Easy installation – only two screws for fastening.



Page 112

Air termination pole base frame with a 2-part base frame

- Benefits:**
- Small space requirement during storage and inside the transport vehicle.
 - Easy transport in lifts, staircases and through roof openings.



Page 133





2015 SPD product range - MOV + GDT type 1+2



- Benefits:**
- Leakage-current free due to series connection of gas discharge tube & varistor.
 - Safe fixation and contact ensured by module locking mechanism.
 - P-HMS 280 G having 12.5 kA (10/350 μ s) /pole and 50 kA (10/350 μ s) 4-pole.
 - Optimal price/performance ratio.
 - Max. backup fuse 160 A gL/gG.
 - Min. cross section for connection 4 mm²

Note: MOV = Metal-oxide varistor
GDT = Gas discharge tube

Page 159



P-HMS 280 Fm G 3



P-HMS 280 Fm G 1+1



P-HMS 280 G 2



P-HMS 280 G 3+1



Surge arrester P-LED 230 type 2+3

- Benefits:**
- SPD type 2+3-arrester in a compact design.
 - Specially designed for the protection of LED applications.
 - Visual function display.
 - Optimal price/performance ratio.

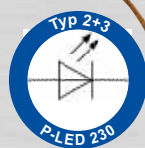

Page 167

Adjustable test joint box



Page 87

for flush mounting on facades with thermal insulation composite systems.

- Benefits:**
- Flexible for use in facades with thermal insulation composite systems.
 - Installation depth of 90-140 mm (Ord. no. 111 585):
Depth can be adjusted trough a simple clamping technique.
 - Installation depth of 130-320 mm (Ord. no. 111 587; 111 588):
Cutting of the spacer by attached markings.
 - No heat bridge due to integrated insulation.
 - The insulating stainless-steel cover V2A complies with protection class IP65.
 - Easy measurement of the ground circuit resistance with earth test tongs.
 - Installation is facilitated by plasterwork covering.



Further factory expansion in Deining



Another newly constructed production hall in plant III in Deining with a space of 4.000 sqm





2016

Connection clamp with clamping bracket and spring



Page 99

- Benefits:**
- Maximal contact safety with regular contact pressure
 - Reduced and simplified installation:
 - Only one screw M10.
 - Spring keeps strap up during the installation.
 - Universal use.
 - The reinforcement and ground conductors are positioned in the component by guiding corrugations and connected with just one clamping bolt capable of carrying lightning current.



Mounting aid for connection clamps



Page 119

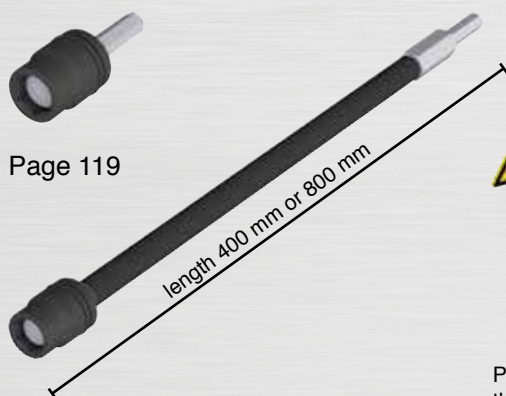

Position mounting aid with the magnetic side of the socket wrench on the hexagonal screw of the connecting clamp.

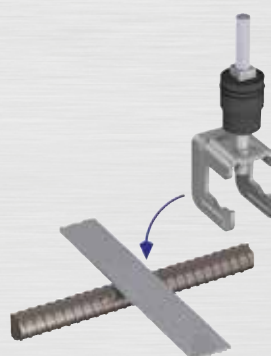

Position the clamp on the desired installation place.

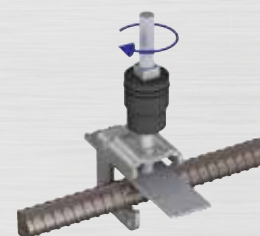

Tighten the positioned clamp until the required torque is reached. (you can also use a cordless screwdriver)

Manual straightening tool – light & heavy version



Light version:

Made of forged steel – chromed surface, hardened straightening bolt. Optimal straightening geometry for quick alignment and bending of round wires.



Heavy version:

Consisting of a stainless steel V2A pipe, PVC handle and a swivelling straightening head made of hardened steel with 3 attached straightening bolts and a tooth slot. The straightening head can be optimally adjusted to the respective work situation with 9 steps.

Page 117

Utilization example:





2016

Heavy connecting – disconnecting clamp (J&P patent)



Page 81

for separators \varnothing 8-10 mm or flat 30 mm

- Benefits:**
- Better form fit with socket wrench due to the patented cylindrical form of the Vario-clamp top.
 - For safe-contact connection of round conductors or strips with steel constructions with a material thickness up to 52 mm.
 - Cost-efficient solution - connecting bracket and test point in one component.

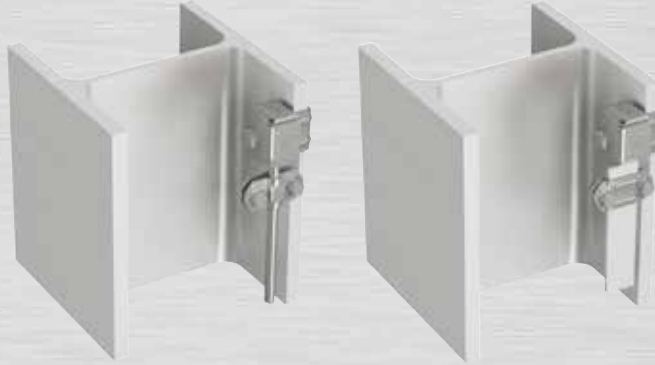

Multi-Mini saddle clamp



Page 79

to connect conductors with joints, metal sheets or profiles (e.g. PV frame etc.)

- Benefits:**
- To connect conductors with metal sheets and profiles up to 8 mm.
 - For conductors 6 - 50 mm² (\varnothing 2.8 - \varnothing 8 mm).
 - Longitudinal and cross conductor connection is possible.
 - Can also be used for potential equalization applications.



Page 79

Attic saddle clamp

to connect the down conductor with the attic sheet without damaging the drip edge.

- Benefits:**
- Connecting clamp for secure contacting of an attic sheet.
 - Simple installation.
 - No damaging or flattening of the drip edge.
 - Especially useful if the clamp has to be repositioned again.



Multi-Quattro connecting and terminal clamp



Page 68

- Benefits:**
- Just one clamp for all connections.
 - Reduced and simplified installation – only one screw M10.
 - For the connection of 2 - 4 wires \varnothing 8 mm.





2016

Roof inclination adjustment of base frames for roof inclinations up to 10°

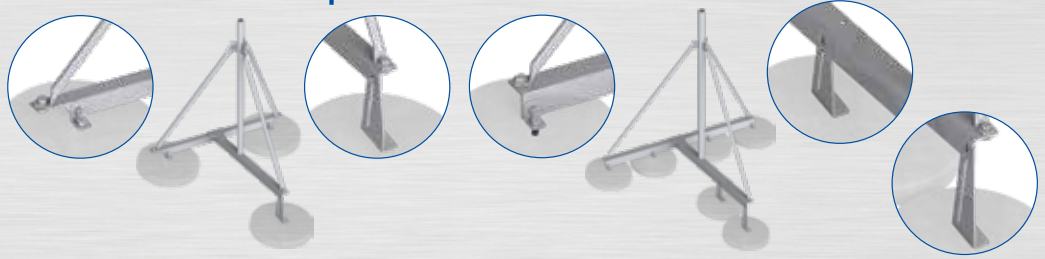
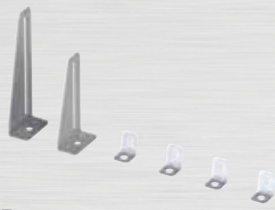

Page 133

Telescopic air termination pole, freestanding, aluminium, with adjustable base frame for roof inclinations up to 10° (JPR utility patent)

- Benefits:**
- Less space required for storage and in transport vehicle (transport / delivery length ca. 2 m).
 - Adjustment of roof inclination up to max. 10°.
 - Easy transport in lifts, staircases and through roof openings.
 - Shorter and easier assembly of the air termination pole with self-locking set screws M8 or M10.
 - Pole heights in the SET adjustable up to 4.35 m, 5.5 m, 6.5 m & 8.0 m.
 - Statically calculated according to Eurocode (EC).

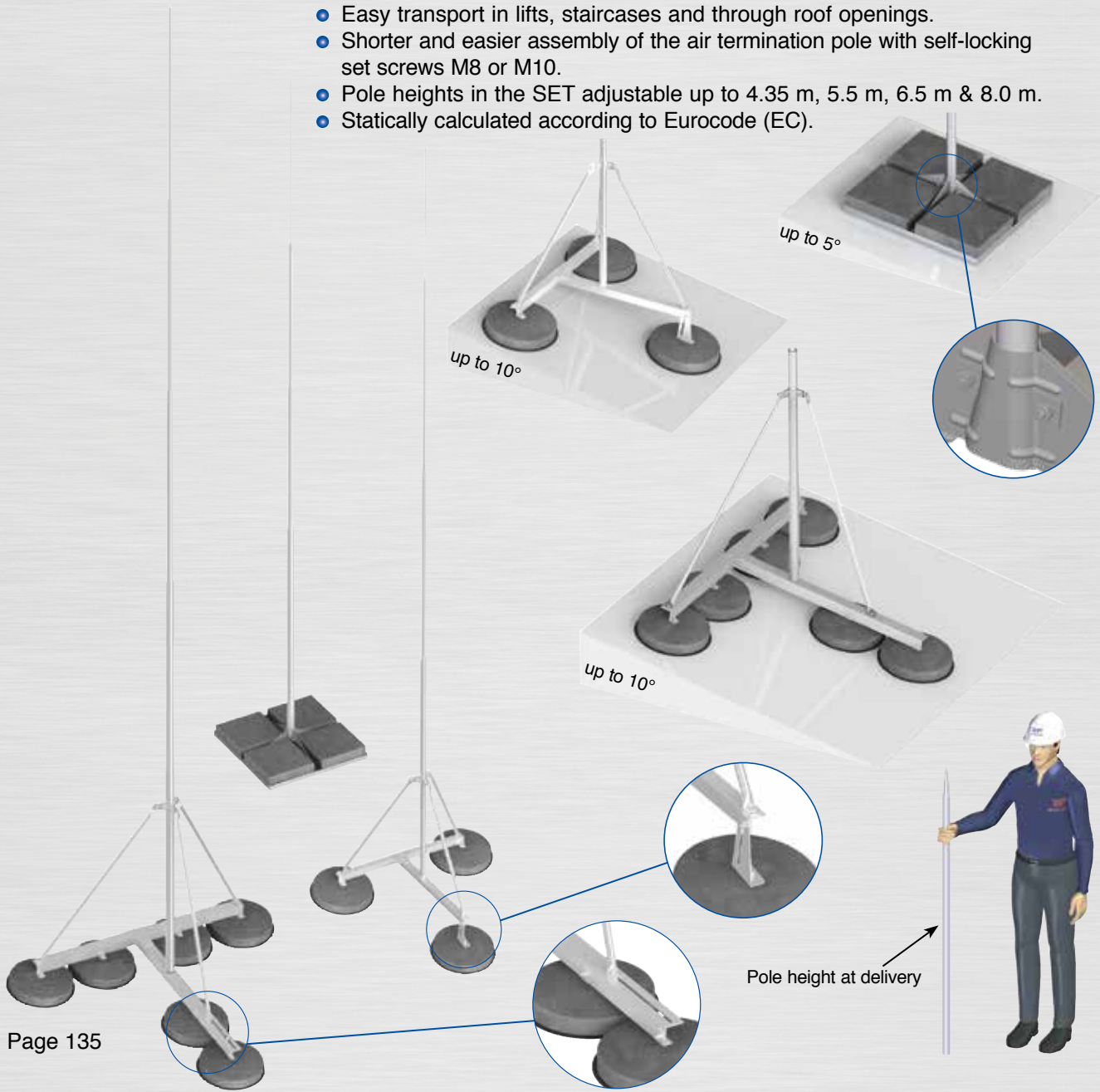

Page 135



2016

Diagonal swiveling cross connecting clamp

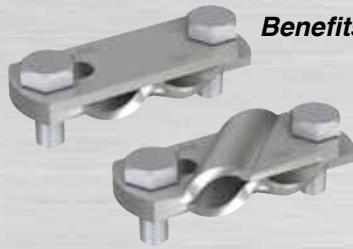

- Benefits:**
- No dismantling of the clamp is necessary.
 - Easier installation than with conventional diagonal clamps because the clamp top has a swivelling opening.
 - Low construction height after the installation.
 - Two hexagon screws M10 (wrench size 17)
 - T-, cross, parallel and diagonal connections are possible.



Page 95



P-1 SQ 5 HF

Surge arrester for high-frequency signal circuits.

Surge arrester (2-pole) for measurement and control technology. Surge protective device according to EN 61643-21, designed as coarse and fine protection for high-frequency, earth-potential free signal circuits.

Page 174

Air termination rod made of stainless steel / aluminium with stainless-steel angular frame for 2 or 3 concrete bases



Page 132

- Benefits:**
- Only small space necessary
 - Low roof loads
 - Easy and quick installation

New fixed earthing terminal system



New fixed earthing terminals and wall bushings, especially for high 50 Hz current rating according to EN 50522

Page 103

Multi-Plus saddle clamp

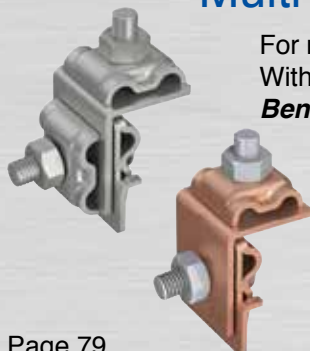

For metal sheet connections lengthwise and crosswise conductor leading. With angle and one or two double connecting clamps. Clamping range up to 8 mm.

- Benefits:**
- Conductor leading is possible in lengthwise and crosswise direction above the standing seam.
 - 10 cm² contact surface on standing seam or sheet

Page 79

2016

Quick connector for reinforcements up to \varnothing 16 mm



to connect reinforcements and round conductors \varnothing 6-16 mm / \varnothing 10 mm.
Benefits:

- Quick and easy assembly – just one clamping screw M10.
- T and cross connections are possible.

Page 98

Connecting clamp - small



For various combinations. With clamping screw M10.

Benefits:

- Cost-efficient solution for connecting flat conductors with small reinforcement rods.
- Compact design.
- Only one clamping screw M10.

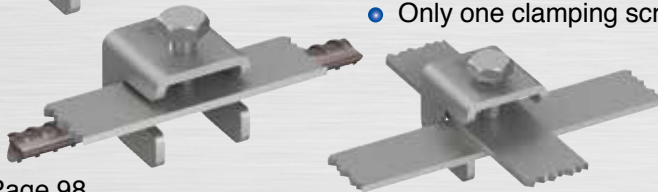

Page 98

Multi-flat/round connecting clamp

Now available also with countersunk screw and carriage bolt.

For a quick and easy connection of ground conductors with the reinforcement.

Other benefits:

Benefit of the countersunk allen screw:

- Extremely low design for a small concrete cover.

Benefit of the carriage bolt:

- Quick component installation.

Benefit of the turned carriage bolt:

- Facilitates the laying of the ground conductor underneath the reinforcement.



Page 96

Air termination rod holder for ridge tiles, acc. to EN 62561-2

Benefits:

- Large clamping range for ridge tiles of 150-300 mm width.
- Quick and easy toolfree preadjustment of the desired clamping range by means of two symmetrical clamping bracket with self-retaining locking catches.
- Direct connection option capable of carrying lightning current of the ridge/down conductor on the air termination rod holder.

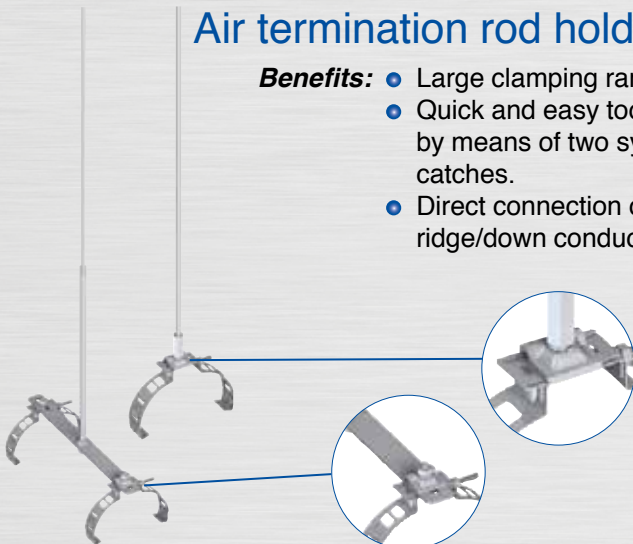

Page 41



2017 HVC-conductor - High voltage resistant conductor

- Benefits:**
- Significantly reduced installation work and time.
 - The required equipotential bonding is provided by the integrated shield braid in the conductor – no separate conductor is needed.
 - Mechanical and chemical protection by light grey, UV-resistant protective jacket.
 - Equivalent separation distance “s” = **0.85 m** in air.
 - No additional separation distances must be observed in the base area.

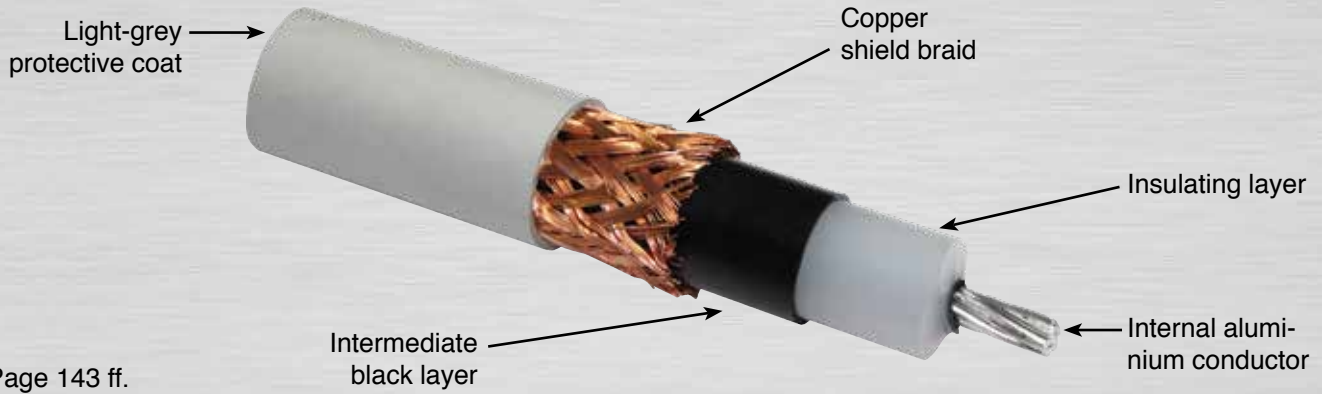

Page 143 ff.





Conductor fastener and air termination poles for HVC

Page 146 ff.

Introduction of a complete product series for fixing HVC conductor.

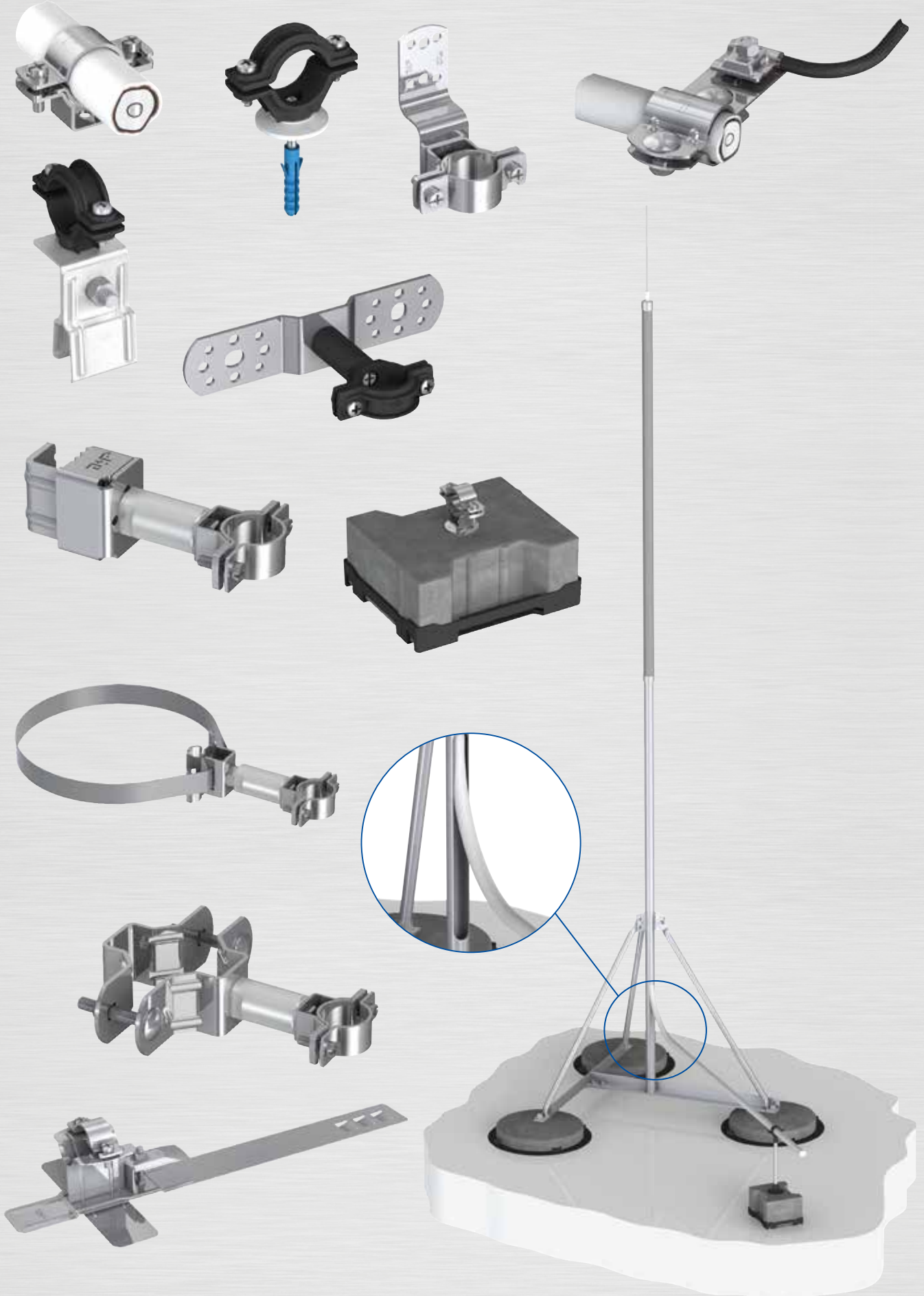



2017 Further factory expansion in Deining



Another newly constructed production hall in plant III in Deining with a space of 4.000 sqm



Multi-Max reinforcement clamp 75 x 75 mm

for the connection of earth conductors with reinforcement.

- Benefits:**
- No loose components during installation.
 - Only one screw M12 = central contact pressure.
 - All existing connection types such as T-, cross-, parallel- and diagonal- connection are possible.
 - Various diameters from \varnothing 8 mm to \varnothing 32 mm are possible.



Page 97

Multi-Max reinforcement clamp 50 x 50 mm

for the connection of earth conductors with reinforcement.

Available in different versions.

- Benefits:**
- No loose components during installation.
 - Only one screw M12 = central contact pressure.
 - All existing connection types such as T-, cross-, parallel- and diagonal- connection are possible.
 - Suitable for conductors flat 30x3.5 mm or \varnothing 10 mm.
 - Low construction height.



Page 97



Benefit of a carriage bolt:

- Fast component installation.

Benefit of a turned carriage screw:

- Installation of conductor underneath reinforcement is possible.



Page 97

Other Benefit: Benefit of a threaded bolt:

- Assembly possible in two steps:
 1. Connect the foundation earth electrode (round) to the reinforcement
 2. Connect and fix the fixed earthing terminal to the reinforcement

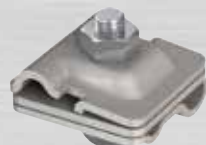

Page 97

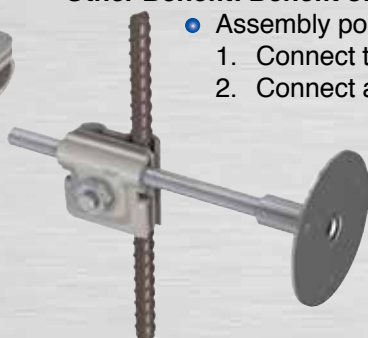

J.P. -developments and innovations become lightning protection standards!



Table of contents - Main catalogue 2018

Round wires, strips, cables and air termination rods Page 31-42

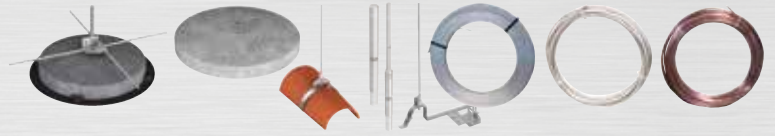

Wall and roof conductor holder Page 43-62

Niro-Clip · Conductor fastener · Pipe clamps · Roof conductor holder



PRÖCOLOR & colour design in lightning protection Page 63-66

Roof conductor holder in PRÖCOLOR · powder-coated components



Connection clamps, terminal clamps Page 67-90

Gutter clamps · System Multi-clamp · Disconnecting clamps · Connectors · System Vario-clamp · Saddle clamps · System bimetal · bridging components · Pipe clamps



Earthing material Page 91-110

Earth lead-in rods · Connection clamps · Earth rods · Tubular earth rods · Fixed earthing terminals



Equipotential bonding systems Page 111-114

Bonding bars · Earthing busbars



Accessories Page 115-120

Straightening device for wires and strips · Bolts and nuts · Earth tester



Insulated lightning protection, Air termination systems Page 121-140

Insulated lightning protection air termination poles · Insulated stand-offs · Air termination poles up to 28 m · Lightning protection for radio and mobile phone antennas



HVC - high voltage conductor Page 141-156

HVC - conductor · Air termination poles for HVC · Conductor fastener for HVC · Equipotential bonding · Accessories



Surge protection (short overview) Page 157-182

Power supply · photovoltaic systems · measurement and control technology · information technology · accessories



Wires, Strips, Cables, Air termination rods
Wall and roof conductor holders
Colour design in lightning protection
Connection and terminal clamps
Earthing material
Equipotential bonding
Accessories
Insulated lightning protection
HVC-Conductor
Surge protection

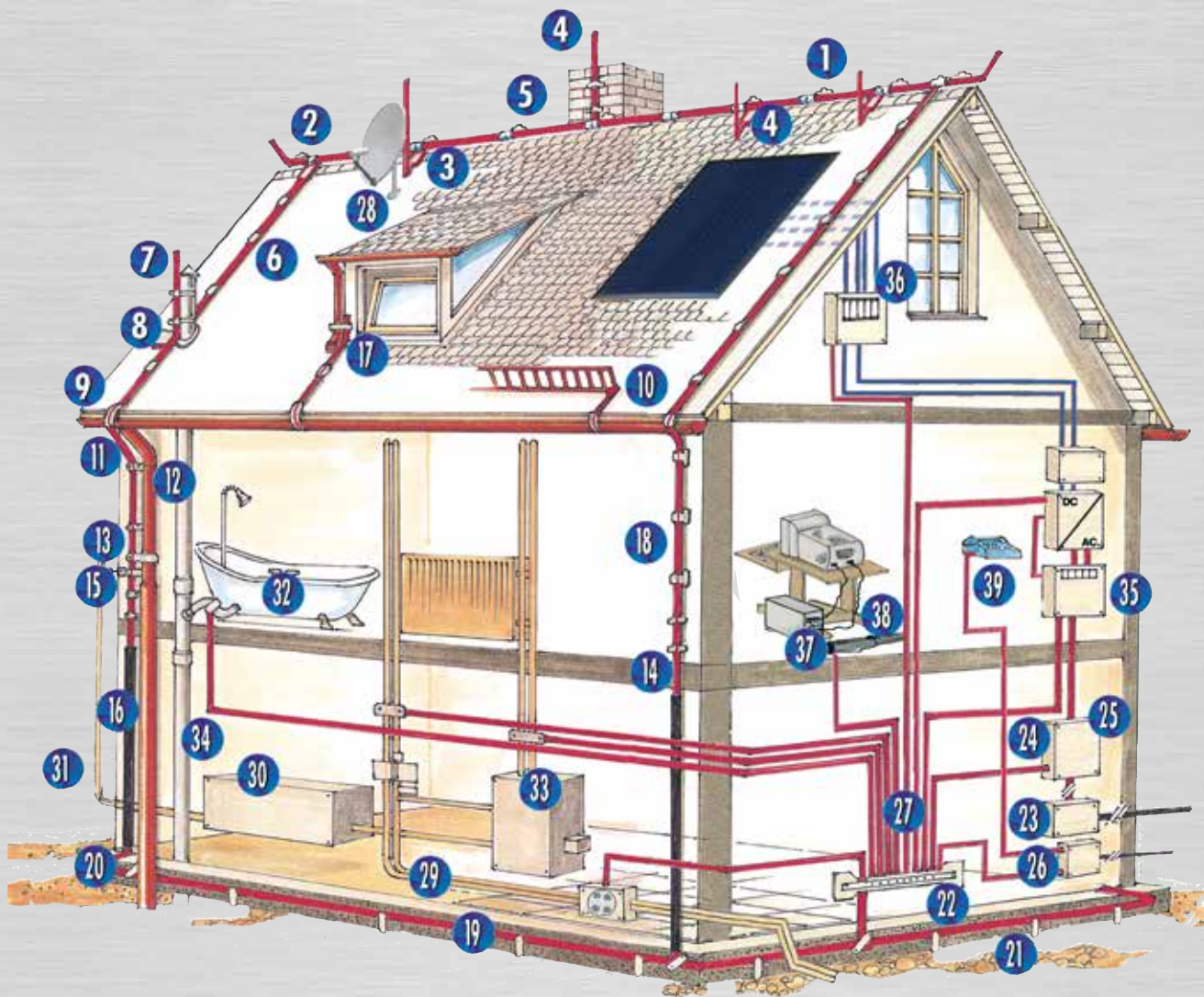

External lightning protection system

- 1 Roof conductor holder for ridge tiles
- 2 Multi-clamp
- 3 Air termination rod with insulated stand-off
- 4 Air termination rod
- 5 Rod holder
- 6 Roof conductor holder
- 7 Pipe clamp
- 8 KS clamp
- 9 Gutter clamp
- 10 Snow guard clamp
- 11 Wall conductor holder
- 12 Downpipe conductor fastener
- 13 Isolating spark gap
- 14 Disconnecting clamp flat/round
- 15 Tape conductor holder
- 16 Insulation
- 17 Saddle clamp
- 18 Down conductor
- 19 Earth electrode
- 20 Diagonal-cross clamp
- 21 Spacer for conductor

Internal lightning protection system

- 22 Main earthing terminal
- 23 House connection box
- 24 Main distribution board
- 25 Combined lightning current and surge arrester
- 26 Surge arrester for telecommunication
- 27 Equipotential bonding conductor
- 28 Antenna grounding / coax protection
- 29 Water supply
- 30 Oil tank
- 31 Oil tank ventilation
- 32 Bathtub
- 33 Heating system
- 34 Wastewater pipe
- 35 Surge arrester
- 36 Surge arrester for photovoltaic systems
- 37 Surge arrester for data networks
- 38 Surge arrester type 3
- 39 Telephone system



Round wires, strips, cables, air termination systems

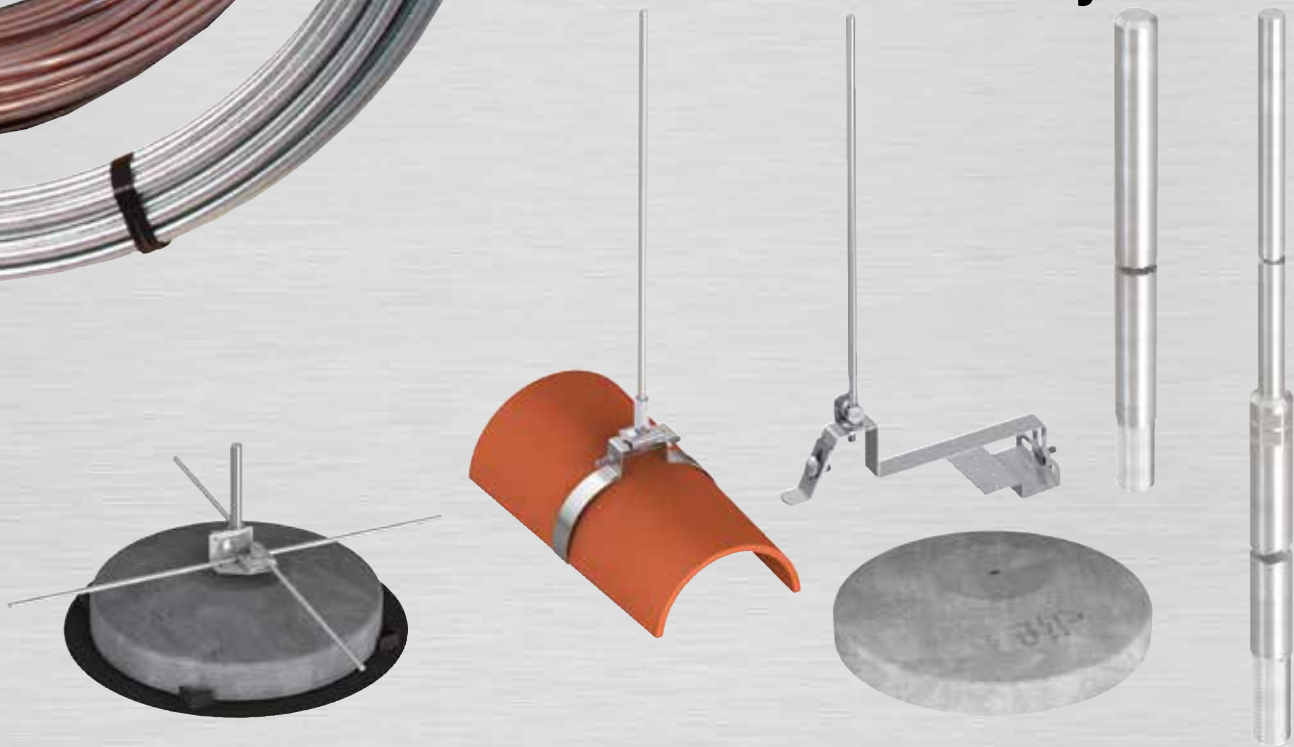



Wires, Strips, Cables, Air Termination rods

Strips



Ord. no. 100 336



Straightening tool for strips



Ord. no. 111 083

Cables



Ord. no. 100 038



Sign and protective cap



Ord. no. 102 220



Ord. no. 102 219

Conductors for lightning protection and earthing systems

- Different materials.
- Available in various dimensions.

Strips according to EN 62561-2.

Specification		Size	Weight/m	PU	Ord. no.
Steel, hot galvanized	Z 500	30 x 3.5 mm	0.84 kg	50 kg	100 336
Steel, hot galvanized	Z 500	30 x 3.5 mm	0.84 kg	25 kg	100 336k
Steel, hot galvanized	Z 500	30 x 4.0 mm	0.96 kg	50 kg	113 231
Steel, hot galvanized	Z 500	40 x 4.0 mm	1.28 kg	50 kg	100 440
Steel, hot galvanized	Z 500	40 x 5,0 mm	1.60 kg	50 kg	100 540
Steel, hot galvanized	Z 500	20 x 2,5 mm	0.40 kg	50 kg	100 225
Stainless steel V2A 1.4301		30 x 3.5 mm	0.83 kg	50 kg	100 114
Stainless steel V2A 1.4301		30 x 3.5 mm	0.83 kg	25 kg	100 114 k
Stainless steel V4A (e.g. 1.4571)		30 x 3.5 mm	0.83 kg	50 kg	100 112
Stainless steel V4A (e.g. 1.4571)		30 x 3.5 mm	0.83 kg	25 kg	100 112 k
E-copper	medium	20 x 2,5 mm	0.45 kg	run.m.	100 118

Straightened and/or **perforated** strips on request (customized performance pattern).

Earthing components, like connection clamps, fixed earthing terminals, etc. on page 91.

Example for the on end installation of flat strips in the foundation area

Ord. no. 1321, 1319 or 1321 S on page 93:

Straightening tool for strips with 5 levelling rolls, for strips 30 x 3.5 mm

Technical data	PU	Ord. no.
Weight: 23 kg, Length: 1390 mm, Width: 120* mm, Height: 670 mm (* base can be swivelled in) Uncoil, straighten and install in one step. Very easy handling, time saving due to clean, effortless and quick installation of earth strips.	1	111 083

Cables according to EN 62561-2.

Specification according to EN 62561-2	Cross section	Weight/m	PU	Ord. no.
Aldrey cable	50 mm ²	0.135 kg	run.m.	100 058
E-copper	bare 50 mm ²	0.438 kg	run.m.	100 033
E-copper	bare 70 mm ²	0.597 kg	run.m.	100 034
E-copper	bare 95 mm ²	0.846 kg	run.m.	100 035
E-copper	bare 120 mm ²	1.061 kg	run.m.	100 036
E-copper	tinned 50 mm ²	0.438 kg	run.m.	100 037
E-copper	tinned 70 mm ²	0.597 kg	run.m.	100 038
E-copper	tinned 95 mm ²	0.846 kg	run.m.	100 039
E-copper	tinned 120 mm ²	1.061 kg	run.m.	100 040
YYY-I underground cable E-copper 1 kV	50 mm ²	0.615 kg	run.m.	100 043

Cables for equipotential bonding.

Specification	Cross section	Outer diameter	Weight/m	PU	Ord. no.
Steel, hot galvanized	38 mm ²	ø 10 mm	0.380 kg	run.m.	100 030
Stainless steel V4A 1.4401	27 mm ²	ø 8 mm	0.250 kg	run.m.	100 041
Stainless steel V4A 1.4401	44 mm ²	ø 10 mm	0.380 kg	run.m.	100 042

Conductor holder for cables on page 50

Sign "ACHTUNG! Blitzschutz/Erdung" and Protective cap for earthing conductor

Specification	Length	Fit	PU	Ord. no.
Signpost PVC (printed on both sides)	200 x 50 mm	up to ø 10 mm or up to flat 40 x 4 mm	10	102 220

On request, also with your company logo and translated text. Price on request.

NEW Protective cap plastic (HD-PE) yellow	ø 10 mm or flat 30 x 3.5 mm	50	102 219
--	-----------------------------	----	---------



Round wires according to EN 62561-2.

Specification		Size	Weight/m	PU	Ord. no.
Steel, hot galvanized	Z 350	ø 8 mm	0.40 kg	40 kg	100 008
Steel, hot galvanized	Z 350	ø 10 mm	0.62 kg	50 kg	100 010
Aluminium AlMgSi 0.5	medium F 15	ø 8 mm	0.135 kg	20 kg	100 018
Aluminium AlMgSi 0.5	soft F 9	ø 8 mm	0.135 kg	20 kg	100 019
Aluminium	soft F 6	ø 10 mm	0.212 kg	20 kg	100 020
E-copper	medium F 25	ø 8 mm	0.45 kg	50 kg	100 028
E-copper	soft F 22	ø 8 mm	0.45 kg	50 kg	100 029
E-copper	soft F 22	ø 8 mm	0.45 kg	25 kg	100 029 k
Stainless steel V2A 1.4301		ø 8 mm	0.40 kg	~ 40 kg	100 011
Stainless steel V2A 1.4301		ø 10 mm	0.62 kg	~ 50 kg	100 012
Stainless steel V4A		ø 8 mm	0.40 kg	~ 40 kg	100 014
Stainless steel V4A		ø 10 mm	0.62 kg	~ 50 kg	100 015
Steel with PVC coating		ø 10/ø 13 mm	0.68 kg	50 kg	100 013
Steel with PVC coating		ø 8/ø 11 mm	0.44 kg	50 kg	100 121

Aluminium wire, powder-coated, upon request. For colour scale, see page 65, or acc. to your wishes

ISO - Fugal down conductor wire according to EN 62561-2.

Specification	Size	Weight/m	PU	Ord. no.
Aluminium alloy AlMgSi 0.5 with halogen-free plastic coating	ø 8/ø 11 mm	0.20 kg	20 kg	100 123

Round wire made of aluminium with copper coating

Specification	Size	Weight/m	PU	Ord. no.
Aluminium core with copper coating (Al/Cu)	soft ø 8 mm	0.18 kg	20 kg	100 022

Universal straightening tool, with vertical reel-off unit, to be used for round wire ø 8 - 10 mm and for earth strips 30 x 3.5 mm.

Technical data	PU.	Ord. no.
Weight: 47 kg; Straightening device (as described on page 116) Vertical reel-off unit, adjustable to different ring diameters. Uncoiling of earth strips 30 x 3.5 also possible.	1	111 082

Round wire



Ord. no. 100 010

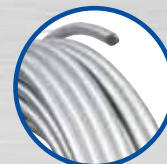

ISO - Fugal down conductor wire



Ord. no. 100 123



Round wire PräCu/Al



Ord. no. 100 022



Universal straightening tool



Ord. no. 111 082



Optimal air termination rod with M16 thread



Ord. no. 103 111

Air termination rod with M16 thread



Ord. no. 103 100

Concrete base with M16 female thread



Ord. no. 103 103

Support plate



Ord. no. 103 102

J.Pröpster optimal air termination rods with air termination tip

Technical benefits that convince the experts:

- Visually attractive - optimal static designed.
- Ideal coordination of protective effects and material requirements.
- Minimum surface area exposed to the wind and maximum protection.
- Reduced load pressure on roof covering and insulation.

Optimal air termination rods with M16 thread according to EN 62561-2

Specification	Length	PU	Ord. no.
Aluminium AlMgSi 0,5 ø 16 mm with M16 thread	1500 mm	10	103 111
and air termination tip ø 10 mm, 1 m long	2000 mm	10	103 112
longer than 2500 mm with lock nut	2500 mm*)	10	103 113
	3000 mm*)	10	103 114
	4000 mm*)	10	103 117
	5000 mm*)	10	103 128
	6000 mm*)	10	103 143

*) only with additional, insulated stand-off (see page 124-128)
From 5 m also available in 2-parts (price on request)

Air termination rods with M16 thread

for flat roofs and the protection of roof installations according to EN 62561-2

Specification	Length	PU	Ord. no.
Air termination rods ø 16 mm made of	1000 mm	10	103 100
Aluminium AlMgSi 0,5 with M16 thread	1500 mm	10	103 150
longer than 2500 mm with lock nut	2000 mm	10	103 200
	2500 mm*)	10	103 250

Additional lengths on request!

*) only with additional, insulated stand-off (see page 124-128)

Concrete base with stainless steel threaded sleeve for air termination rods with M16 thread for flat roofs to protect roof installations.

Specification	Weight	Diameter	PU	Ord. no.
Concrete base	12 kg	ø 380 mm	1	103 103
with female thread M16	16 kg	ø 380 mm	1	103 101
as socket for air termination rods	20 kg	ø 380 mm	1	103 110
	25 kg	ø 420 mm	1	103 118

Support plate for concrete base round (up to ø 445) and concrete base (300 x 300 mm) to protect roofing material. Neutral to all conventional roof foils.

Specification	Diameter	PU	Ord. no.
Plastic, black - without plasticizer	ø 445 mm	1	103 102
	300 x 300 mm		

The support plate for concrete base is necessary on synthetic roofing membranes.



Telescopic-air termination pole, free-standing aluminium with base frame for roof inclinations up to 10°

Benefits:

- Less space required for storage and in transport vehicle (**transport / delivery length ca. 2 m**).
- Adjustment of roof inclination up to max. 10°.
- Easy transport in lifts, staircases and through roof openings.
- Shorter and easier assembly of the air termination pole with self-locking set screws M8 or M10.
- Pole heights in the SET adjustable up to 4.35 m, 5.5 m, 6.5 m & 8.0 m.
- Statically calculated according to Eurocode (EC)

Telescopic-air termination pole-SET in aluminium, freestanding incl. base frame with roof inclination adjustment, concrete bases and support plates.

Height of pole	Pole parts	Base frame	Concrete base	Ord. no.
up to 4.35 m	4-part	499 000 (5°)	4x 16 kg	912 601
up to 5.50 m	4-part	912 300 (10°)	3x 25 kg	912 600
up to 6.50 m	5-part	912 310 (10°)	6x 12 kg	912 602
up to 8.00 m	6-part	912 311 (10°)	6x 25 kg	912 603

Note: The air termination pole base frame must be secured against slipping from a roof inclination of 5°.

Roof inclination adjustment up to 10° (ord. no. 499 700) for the base frame (ord. no. 499 000) see on page 132.

Wind speed according to Eurocode:

Height of pole	SET ord. no.	Wind speed	
		Static safety factor 1.0	Static safety factor 1.5
up to 4.35 m	912 601	146 km/h	119 km/h
up to 5.50 m	912 600	161 km/h	130 km/h
up to 6.50 m	912 602	142 km/h	116 km/h
up to 8.00 m	912 603	155 km/h	127 km/h

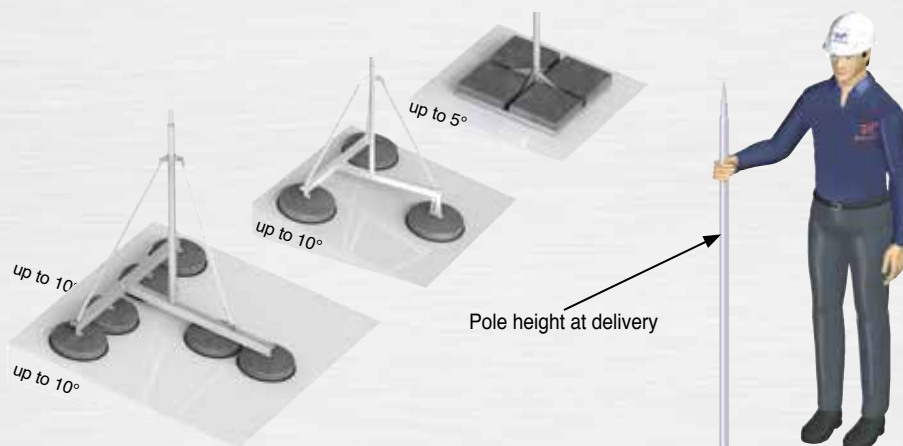

NEW!

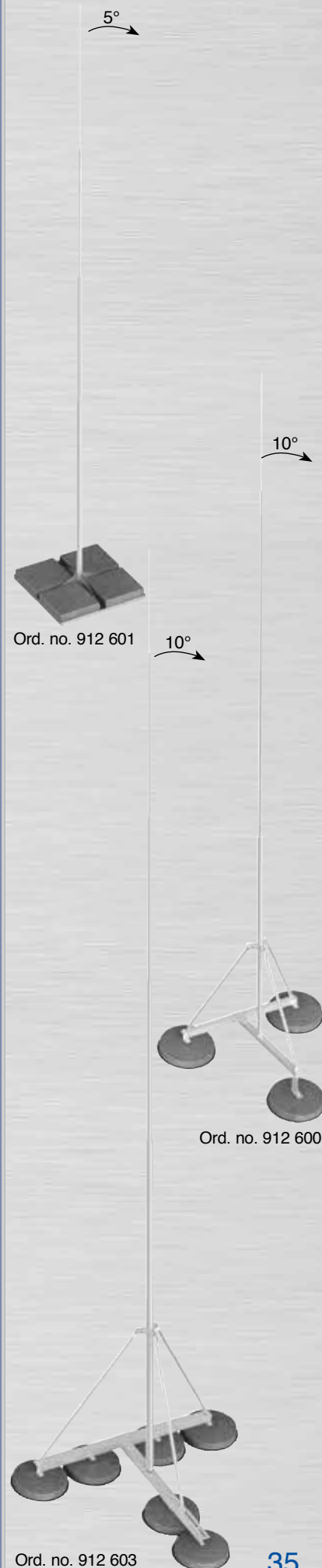

Telescopic-air termination pole aluminium for wall mounting unsupported up to 6.5 m air termination pole height (mounting length 1.5m)

Height of pole	Pole parts	Necessary wall fastener	PU	Ord. no.
up to 4.35 m	4-part	2x Type A, (on page 134)	1	912 401
up to 5.35 m	4-part	2x Type B, (on page 134)	1	912 400
up to 6.50 m	5-part	2x Type C, (on page 134)	1	912 402
up to 8.00 m	6 part	2x Type C, (on page 134)	1	912 403

Ord. no. 912 603



Concrete base with J.Pröpster - wedge technology

Benefits:

- Tilting of the air termination rod adjustable to the roof.
- Curving the air termination is not necessary.
- High quality: Wedge + clamp completely made of stainless steel V2A.
- Safety - "100 kA tested".
- Specification: Compressed frost-proof concrete base 16 kg - with recessed grip.
- Installation and price benefits: J.Pröpster wedge technology including connection clamp for the roof conductor -all in one.



Concrete base with wedge technology

(J.P. patent)

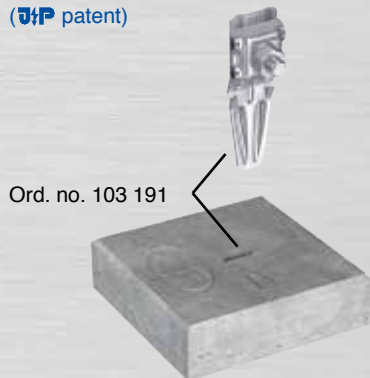

Ord. no. 103 191

Support plate



Ord. no. 103 188

Optimal air termination rod without thread



Ord. no. 103 180

Ord. no. 103 170

Concrete base with J.Pröpster - wedge technology, for air termination rods for flat roofs to protect roof installations.

Specification	Fit wege	PU	Ord. no.
Concrete base 16 kg; 300 x 300 x 80 mm with wedge connection clamp stainless steel V2A for air termination rod ø 16 mm	ø 8 mm	1	103 191
Support plate; Neutral towards all synthetic roofing membranes Plastic, black - without plasticizer		1	103 188

The support plate for concrete base is necessary on synthetic roofing membranes.

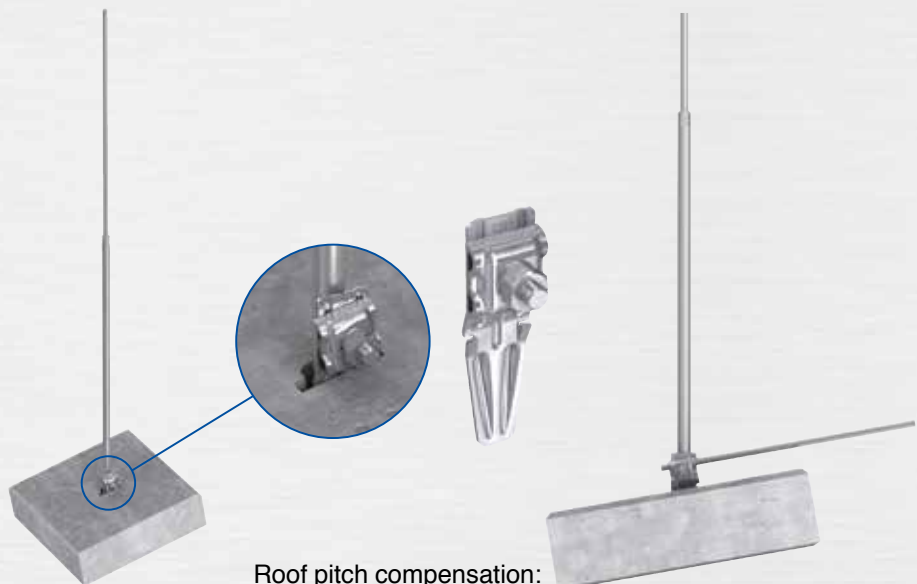

Roof pitch compensation:

J.Pröpster - Optimal air termination rods without thread

for concrete base 16 kg with J.Pröpster - wedge technology, according to EN 62561-2.

Specification	Length	PU	Ord. no.
Optimal air termination rod ø 16 mm with air termination tip ø 10 mm, 1 m long Material: Aluminium AlMgSi 0,5	1500 mm	10	103 180
	2000 mm	10	103 181
	2500 mm*)	10	103 182
	3000 mm*)	10	103 183
Tube air termination rod , tube ø 16 x 3 mm with air termination tip ø 10 mm, 1 m long Material: Aluminium AlMgSi 0,5	1500 mm	10	103 170
	2000 mm	10	103 171
	2500 mm*)	10	103 172
	3000 mm*)	10	103 173
	4000 mm*)	10	103 174
	5000 mm*)	10	103 174 S
	6000 mm*)	10	103 168

*) only with additional, insulated stand-off (see page 124-128)

From 5 m also available in 2-parts (price on request)

k_C-clamp

NEW!

special clamp for cross connection of conductors
incl. an additional air termination rod

Benefits:

- All connection types (cross, T-, corner, parallel, end-to-end connection) and additional connection of one air termination rod or tip with solely one clamp.
- Connection of crossing points of conductor leading and one air termination rod also without concrete base.
- Easy kc value reduction by the factor 0.25 by splitting up the current path.
- Also to be used in existing systems.

k_C-clamp according to EN 62561-1 class H (10/350μs)

Specification	Fit	Air termination rod	PU	Ord. no.
Aluminium - steel, hot galvanized	ø 8 mm / ø 8 mm	ø 16 mm	25	111 298
Aluminium - stainless steel V2A	ø 8 mm / ø 8 mm	ø 16 mm	25	111 299
Aluminium - stainless steel V2A	ø 8 mm / ø 8 mm	ø 10 mm	25	111 297

Example of application:

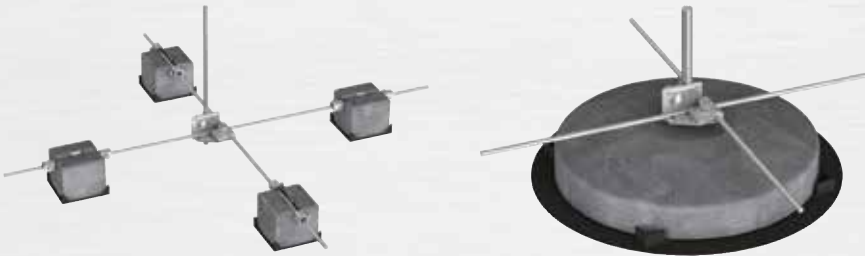

Wedge technology incl. k_C-clamp

according to EN 62561-1 class H (10/350μs)

Specification	Fit	Air termination rod	PU	Ord. no.
Aluminium - stainless steel V2A	ø 8 mm / ø 8 mm	ø 16 mm	25	111 296

Detail drawing of wedge fixture:

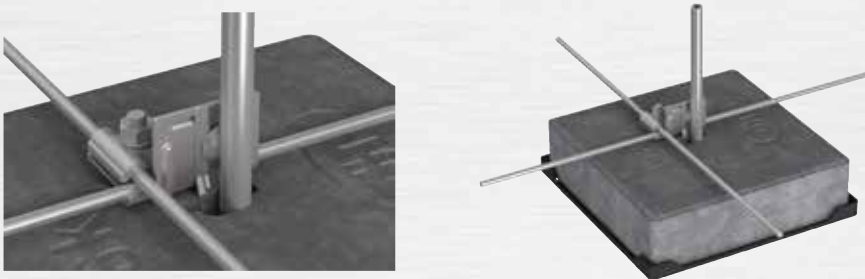

Concrete base for k_C-clamp with J.Pröpster wedge technology

Specification	PU	Ord. no.
Concrete base 16 kg; 300 x 300 x 80 mm for k _C -clamp with wedge fixture	1	103 185
Support plate; neutral to all roof foils plastic (black) – without plasticizers	1	103 188

Foil roofs must have a support plate for the concrete base.

k_C-clamp (J.P. patent)



Ord. no. 111 299

k_C-clamp with wedge technology (J.P. patent)



Ord. no. 111 296

Concrete base for k_C-clamp with wedge technology



Ord. no. 103 185



Air termination rods, $\varnothing 16$ mm



Ord. no. 100 750

Air termination rod system Kal-Zip & RIB-ROOF



Ord. no. 910 247

Ord. no. 910 248

Roof pitch compensation



Ord. no. 920 181 S

Ord. no. 920 181

Air termination rods, $\varnothing 16$ mm, chamfered on both sides, acc. to EN 62561-2.

Specification	Fit	Length	PU	Ord. no.
Steel, hot galvanized	$\varnothing 16$ mm	750 mm	10	100 750
Steel, hot galvanized	$\varnothing 16$ mm	1000 mm	10	101 000
Steel, hot galvanized	$\varnothing 16$ mm	1200 mm	10	101 200
Steel, hot galvanized	$\varnothing 16$ mm	1500 mm	10	101 500
Steel, hot galvanized	$\varnothing 16$ mm	2000 mm	10	101 002
E-Copper	$\varnothing 16$ mm	1000 mm	10	101 005
E-Copper	$\varnothing 16$ mm	1200 mm	10	101 205
E-Copper	$\varnothing 16$ mm	1500 mm	10	101 505
Stainless steel V2A	$\varnothing 16$ mm	1000 mm	10	102 005
Stainless steel V2A	$\varnothing 16$ mm	1200 mm	10	102 205
Stainless steel V2A	$\varnothing 16$ mm	1500 mm	10	102 505
Stainless steel V4A	$\varnothing 16$ mm	1000 mm	10	103 137
Stainless steel V4A	$\varnothing 16$ mm	1200 mm	10	102 207
Stainless steel V4A	$\varnothing 16$ mm	1500 mm	10	910 347
Aluminium AlMgSi 0,5	$\varnothing 16$ mm	1000 mm	10	102 000
Aluminium AlMgSi 0,5	$\varnothing 16$ mm	1200 mm	10	102 200
Aluminium AlMgSi 0,5	$\varnothing 16$ mm	1500 mm	10	102 550

Additional lengths on request!

Connection clamps $\varnothing 8-10$ mm / $\varnothing 16$ mm see page 42.

Air termination rods with mounting cross for Kal-Zip

according to EN 62561-2.

Specification	Length	PU	Ord. no.
Stainless steel V2A complete with Optimal air termination rod (aluminium) and 4 Kal-Zip-mounting clamps (stainless steel V2A)	2000 mm	1	910 247
Stainless steel V2A without Optimal air termination rod and 4 Kal-Zip-mounting clamps (stainless steel V2A)	---	1	910 248
Kalzip mounting clamp (stainless steel V2A) for mounting cross		1	910 242

Air termination rods with mounting cross for RIB-ROOF

according to EN 62561-2.

Specification	Length	PU	Ord. no.
NEW! Stainless steel V2A complete with Optimal air termination rod (aluminium) and 4 RIB-ROOF-mounting clamps (stainless steel V2A)	2000 mm	1	910 257
NEW! Stainless steel V2A without Optimal air termination rod and 4 RIB-ROOF-mounting clamps (stainless steel V2A)	---	1	910 258
NEW! RIB-ROOF mounting clamp (stainless steel V2A) for mounting cross		1	910 243

Note: For other lengths of the Optimal air termination rods with thread M16, see page 34.

Roof pitch compensation stainless steel infinitely adjustable!



Also suitable for concrete base with thread M16

Specification	Fit	PU	Ord. no.
Roof pitch compensation stainless steel V2A for air termination rods $\varnothing 16/10$ mm max. 1.5m length and fixing with CC-Clamp.	$\varnothing 16$ mm	1	920 181
Roof pitch compensation stainless steel V2A for air termination rods $\varnothing 16/10$ mm over 1.5m length. and fixing with Vario-clamp.	$\varnothing 16$ mm	1	920 181 S



Air termination rod system for metal / tin roofs (also for roof inclinations up to 10°)

Air termination rod system with mounting cross, bases incl. **magnetic plates** and KS-Connector, according to EN 62561-2.

Specification	Length	PU	Ord. no.
Mounting cross stainless steel V2A  with 5 bases stainless steel incl. magnetic plate, Air termination rod Aluminium ø 16/10 mm, 1.5 m length and connection with KS-connector	1500 mm	1	919 860
Mounting cross stainless steel V2A  with 4x St-profile each ~ 1.5 kg, magnetic plate, Air termination rod aluminium ø 16/10 mm 2.0 m length and connection with KS-connector	2000 mm	1	919 860 S
Mounting cross stainless steel V2A  with 4x St-profile each ~ 2.0 kg, magnetic plate, Air termination rod aluminium ø 16/10 mm, 2.5 m length and connection with KS-connector	2500 mm	1	919 860 S1

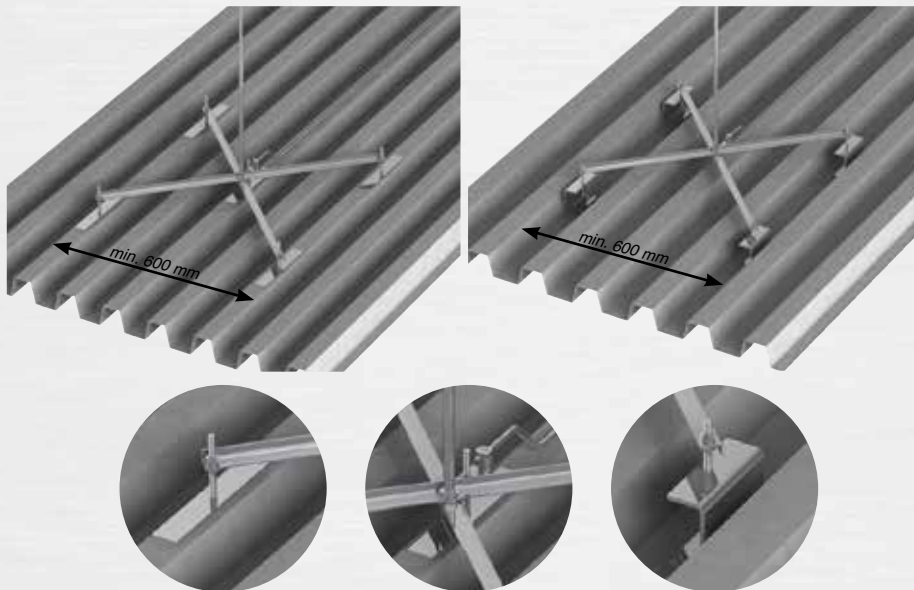

Air termination rod system

(J.P. utility patent)

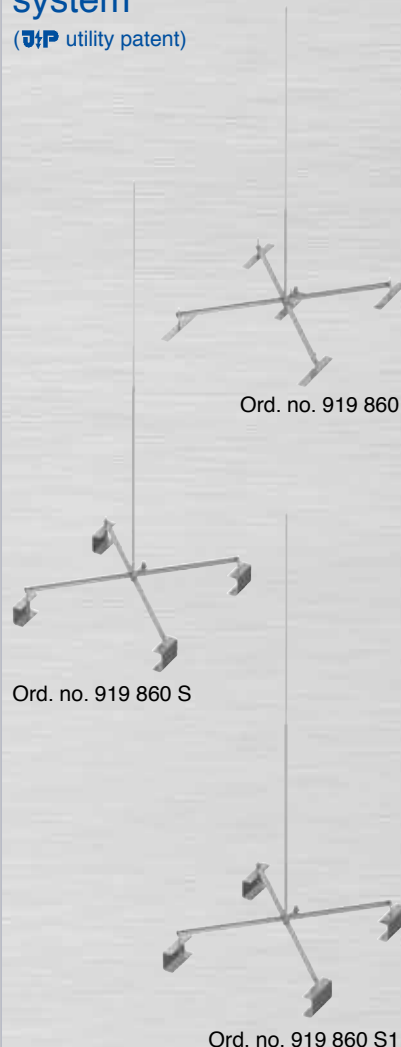

Conductor fastener for metal / tin roofs

Conductor fastener, **stainless steel V2A** with magnetic plate and Niro-Clip **V2A**; for ø 8 mm loose conductor leading incl. plate **V2A** 180x40x3mm.

Specification	Fit	PU	Ord. no.
Stainless steel V2A with Niro Clip 	ø 8 mm / type B	1	920 860

Conductor fastener, **stainless st. V2A** with magnetic plate, Niro-Clip **V2A** and spacer to raise the conductor distance for ø 8 mm loose conductor leading incl. plate **V2A** 180x40x3 mm.

Specification	Height	Fit	PU	Ord. no.
Stainless steel V2A with Niro Clip 	80 mm	ø 8 mm / type B	1	920 860 B

Conductor fastener

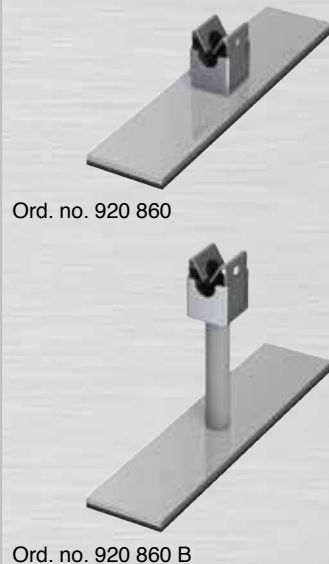

*) **type A (fl)** = fixed conductor leading; **type B (ll)** = loose conductor leading



Air termination rod with M10 thread



Ord. no. 103 147

Concrete base with M10 female thread

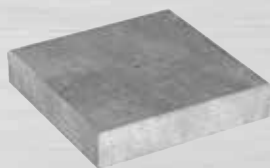

Ord. no. 103 104

Support plate

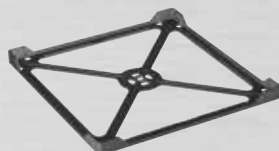

Ord. no. 103 188

Support tool



Ord. no. 103 189

Ord. no. 110 240

Air termination rods with M10 thread

for flat roofs to protect roof installations, according to EN 62561-2.

Specification	Length	PU	Ord. no.
Air termination rods ø 10 mm made of Aluminium AlMgSi 0,5 with M10 thread	500 mm	10	103 147
	750 mm	10	103 148
	1000 mm	10	103 124

Air termination rods ø 10 mm made of Stainless steel V2A with M10 thread	1000 mm	10	103 106
	1200 mm	10	103 107

Additional lengths on request.

Concrete base for air termination rods

for flat roofs to protect roof installations.

Specification	Weight	PU	Ord. no.
Concrete base 300 x 300 x 60 mm with female thread M10	12 kg	1	103 104
Concrete base 300 x 300 x 80 mm with female thread M10	16 kg	1	103 146

Support plate for concrete base

to protect roofing material. Neutral with all roofing materials.

Specification	Size	PU	Ord. no.
Plastic, black - without plasticizer	300 x 300 mm	1	103 188

The support plate for concrete base is necessary on synthetic roofing membranes.

Support tool for concrete base

Specification	Size	PU	Ord. no.
Nylon tissue white	440 x 430 x 100 mm	1	103 189
Reinforced steel ø 12 mm (coated) with soft PVC handle ø 14 mm	for concrete base with wedge technology	1	110 240



Connection set for safety rope systems

NEW!

Benefits:

- No negative impact of the PSA rope glider when passing the rope contacts.
- Length compensation between lightning protection system and rope protection system in case of fall loads.
- Lightning current protected connection to the existing outer lightning protection system.

Connection set for safety rope systems



Ord. no. 111 349

40

Connection set for safety rope systems to connect existing rope protection systems on roofs to the existing down conductor of the lightning protection system

Specification	Rope length	Fit		PU	Ord. no.
		Rope	Lightning protection		
Stainless steel V2A	0.5 m	ø 6 mm	ø 8 - 10 mm	50	111 346
Stainless steel V2A	1.0 m	ø 6 mm	ø 8 - 10 mm	50	111 347
Stainless steel V2A	0.5 m	ø 8 mm	ø 8 - 10 mm	50	111 348
Stainless steel V2A	1.0 m	ø 8 mm	ø 8 - 10 mm	50	111 349
Stainless steel V2A	0.5 m	ø 10 mm	ø 8 - 10 mm	50	111 340
Stainless steel V2A	1.0 m	ø 10 mm	ø 8 - 10 mm	50	111 350

Air termination rod holder for ridge tiles **NEW!**

Benefits:

- Large range for ridge tiles with a width of 150 - 300 mm
- Fast and simple tool-free rough adjustment of the required clamping area by means of two symmetric clamping bracket with self-retaining locking catches
- Direct lightning-current capable connection of the ridge/down-conductor on the air termination rod holder.

Air termination rod holder with a width of 150 - 300 mm, acc. to EN 62561-2.

Specification	Length	PU	Ord. no.
NEW! 1 holder, stainless steel V2A and air termination rod, aluminium ø 10 mm	1050 mm	1	1250
NEW! 2 holder with connection rail, stainless steel V2A and air termination rod, aluminium ø 16/10 mm	1500 mm	1	1251

Example of application:

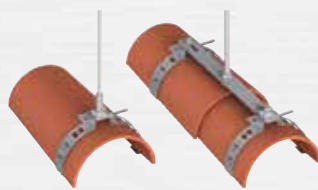

Note:
Pay attention that each ridge tile is screw-fastened to the roof!

Air termination rod system for ridge tiles (size 200 - 220 mm) according to EN 62561-2.

Specification	Length	PU	Ord. no.
1 holder, stainless steel V2A and air termination rod, aluminium ø 10 mm	1050 mm	1	1255
2 holder, stainless steel V2A and air termination rod, aluminium ø 16/10 mm	1350 mm	1	1255 S2

Additional lengths on request!

Example of application:

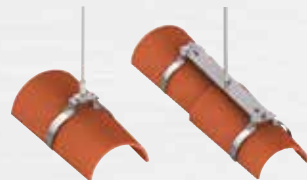

Note:
Pay attention that each ridge tile is screw-fastened to the roof!

Air termination rods for all common types of roof tiles infinitely adjustable to fit the tile, according to EN 62561-2.

Specification	Length	PU	Ord. no.
1 holder, stainless steel V2A - with air termination rod aluminium ø 10 mm	1000 mm	1	1254
2 holder with connection bar, stainless steel V2A - with air termination rod aluminium ø 16/10 mm	1500 mm	1	1254 S2
1 holder, stainless steel V2A - without air termination rod	-	1	1254 S1
2 holder with connection bar, stainless steel V2A - without air termination rod	-	1	1254 S3

On request also available in desired RAL-colour.

Example of application:

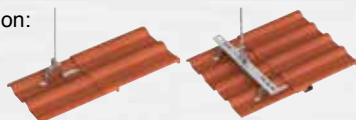

Air termination rods for ridge area in stainless steel V2A; infinitely adjustable, according to EN 62561-2.

Specification	Length	PU	Ord. no.
Holder stainless steel V2A type A: with air termination tip aluminium ø 10 mm	1000 mm	1	1257
with air termination rod aluminium ø 16/10 mm	1500 mm	1	1257 S
Holder stainless steel V2A type B (adjustable to fit the roof inclination): with air termination rod aluminium ø 16/10 mm	2000 mm	1	1259
with air termination rod aluminium ø 16/10 mm	2500 mm	1	1259 S

Air termination rod

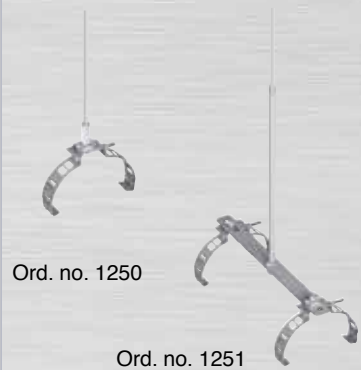

Ord. no. 1250

Ord. no. 1251

Air termination rod

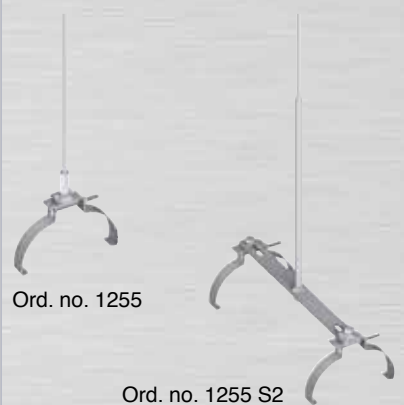

Ord. no. 1255

Ord. no. 1255 S2

Air termination rod

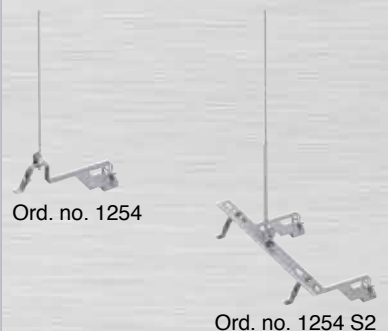

Ord. no. 1254

Ord. no. 1254 S2

Air termination rod

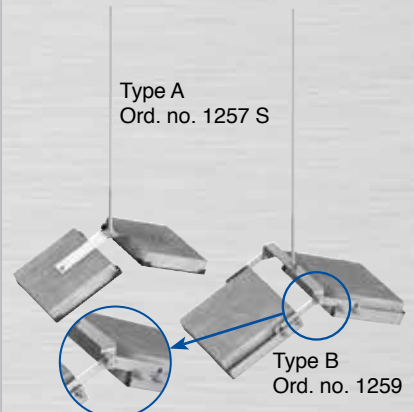

Type A
Ord. no. 1257 S

Type B
Ord. no. 1259 S



Air termination tip



Ord. no. 103 158

Air termination tip with base



Ord. no. 103 125

Air termination stud



Ord. no. 2040

Air termination tip



Ord. no. 1252

U-Connector



Ord. no. 111 410

Multi-Clamp ø 8-10 mm / ø 16 mm



Ord. no. 111 430

Connection clamp for air termination rods ø 16 mm



Ord. no. 2108

Aluminium-air termination tip ø 10 mm with thread M10,
for direct connection to Multi-clamps, for T- and cross connections, according to EN 62561-2.

Specification	Length	PU	Ord. no.
Aluminium AlMgSi 0.5 ø 10 mm	250 mm	10	103 158
with inner thread M10	500 mm	10	103 121
	750 mm	10	103 122

Air termination tips in **stainless steel V2A** on request
Example of application:



Air termination tip with base for flat roofs, to protect small roof installations.
e.g. ventilation systems. For installation along the conductor routing, according to EN 62561-2.

Specification	PU	Ord. no.
Air termination tip with base consisting of: plastic cover (equal to PR-ÖKO 1; page 61), but with 2 kg frost proof concrete filling, contact clamp for conductors ø 8 mm and air termination tip ø 10 mm Aluminium, 1.0 m long	1	103 125

Air termination stud for walkable and passable flat roofs.

Specification	Fit	PU	Ord. no.
Aluminium/steel, hot galvanized	ø 8-10 mm	10	2040
Distance bottom edge clamp / bottom edge air termination stud 50-60 mm			

Flat strips design on request.

Air termination tip for screwing on conductor ends

Specification	Fit	PU	Ord. no.
Aluminium with V2A-bolt M6 x 8 mm	ø 8 mm	100	1252
Copper-alloy with V2A-bolt copper plated M6 x 8 mm	ø 8 mm	100	1253

Terminal and connection clamps for air termination rods

U-Connector

with M10 hexagonal screw V2A for conductors ø 8-10 mm and air termination rods ø 16 mm.

Specification	Fit	PU	Ord. no.
Steel, hot galvanized	ø 8-10/ø 16 mm	100	111 410
Copper	ø 8-10/ø 16 mm	100	111 411
Stainless steel V2A	ø 8-10/ø 16 mm	100	111 412

Multi-Clamp ø 8-10 mm / ø 16 mm

Benefits: The approved System Multi-Clamp for rod connections ø 16 mm.

Specification	Fit	PU	Ord. no.
Steel, hot galvanized	ø 8-10/ø 16 mm	50	111 430
Copper	ø 8/ø 16 mm	50	111 432
Stainless steel V2A	ø 8-10/ø 16 mm	50	111 433

Connection clamp for air termination rods ø 16 mm

for the connection of 2 air termination rods ø 16 mm.

Specification	Fit	PU	Ord. no.
Aluminium, mounted with four M8 hexagonal screw stainless steel V2A	ø 16 mm	25	2108





Niro-Clip conductor fastener system

The **original-Niro-Clip**, the first stainless steel Clip in lightning protection, is a multifunctional fastener system for all round conductor attachments to roofs and walls.

Since its invention by J.PRÖPSTER in 1984, the Niro-Clip has been extremely successful. The unique construction of the patented original Niro-Clip has many benefits.

Benefits:

- Maximal mechanical strength.
- 100% weather resistant.
- Easy handling: simply push in the round conductor and it is secured as if it were screwed on.

**Proven millions
of times
since 1984**

Example of application:

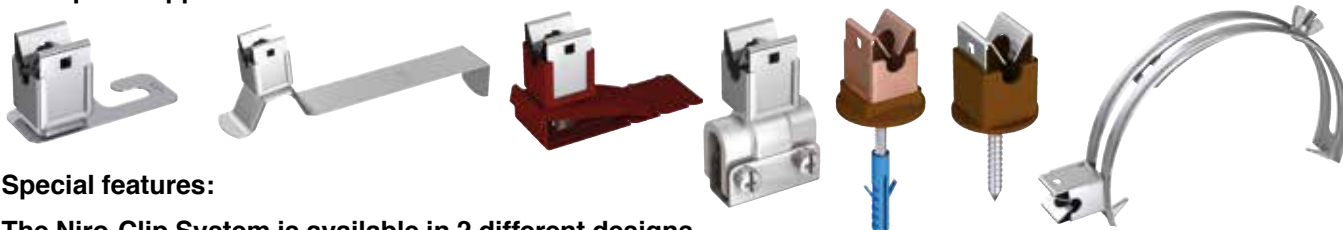

Special features:

The Niro-Clip System is available in 2 different designs.

- **Niro-Clip Type A = fixed conductor leading** - round conductor is clamped down as securely as if it were screwed (e.g. Ord. no. 111 001).
- **Niro-Clip Type B = loose conductor leading** - round conductor can shift inside fastener e.g. when round conductor expands. (e.g. Ord. no. 110 090).

Note:

Round conductor can be removed with special tools (Ord. no. 110 230; Ord. no. 1049; page 117)



Components for conductors ø 10 mm available on request.

Niro-Clip conductor fastener (J.P. patent)



Ord. no. 111 001



Ord. no. 110 090



Since 2017 NEW at Niro-Clip type B:
Rounded edges -
Improved loose conductor leading

Niro-Clip conductor fastener

for fixing round conductor to walls. Fastener and base made of metal.

Type A = fixed conductor leading					
Specification fastener / base	Bore / thread	Fit *)	PU	Ord. no.	
Stainless steel V2A / stainless steel V2A	ø 6.5 mm	ø 8 mm / type A	200	111 001	
Stainless steel V2A coppered / copper	ø 6.5 mm	ø 8 mm / type A	200	111 002	
Stainless steel V2A / stainless steel V2A	M6	ø 8 mm / type A	200	111 005	
Stainless steel V2A coppered / copper	M6	ø 8 mm / type A	200	111 006	
Stainless steel V2A / stainless steel V2A	ø 7 mm	ø 10 mm / type A	200	110 090 S	
Stainless steel V2A / stainless steel V2A	M6	ø 10 mm / type A	200	110 095 S	

Conductor height Niro-Clip type A: 15 mm

Type B = loose conductor leading					
Specification fastener / base	Bore / thread	Fit *)	PU	Ord. no.	
Stainless steel V2A / stainless steel V2A	ø 6.5 mm	ø 8 mm / type B	200	110 090	
Stainless steel V2A coppered / copper	ø 6.5 mm	ø 8 mm / type B	200	110 091	
Stainless steel V2A / stainless steel V2A	M6	ø 8 mm / type B	200	110 095	
Stainless steel V2A coppered / copper	M6	ø 8 mm / type B	200	110 096	

Conductor height Niro-Clip type B: 14 mm

For washers and spacers see page 47

*) **Type A (fl)** = fixed conductor leading; **Type B (ll)** = loose conductor leading



Niro-Clip conductor fastener -high version-

for fixing round conductors to walls. Fastener and base made of metal.

Type A = fixed conductor leading				
Specification fastener / base	Bore / thread	Fit *)	PU	Ord. no.
Stainless steel V2A / stainless steel V2A	ø 6.5 mm	ø 8 mm / type A	100	111 501
Stainless steel V2A coppered / copper	ø 6.5 mm	ø 8 mm / type A	100	111 502
Stainless steel V2A / stainless steel V2A	M6	ø 8 mm / type A	100	111 503
Stainless steel V2A coppered / copper	M6	ø 8 mm / type A	100	111 504
Stainless steel V2A / stainless steel V2A	ø 7 mm	ø 10 mm / type A	100	111 509
Stainless steel V2A / stainless steel V2A	M6	ø 10 mm / type A	100	111 510

Conductor height Niro-Clip high version type A: 36 mm

Type B = loose conductor leading				
Specification fastener / base	Bore / thread	Fit *)	PU	Ord. no.
Stainless steel V2A / stainless steel V2A	ø 6.5 mm	ø 8 mm / type B	100	111 505
Stainless steel V2A coppered / copper	ø 6.5 mm	ø 8 mm / type B	100	111 506
Stainless steel V2A / stainless steel V2A	M6	ø 8 mm / type B	100	111 507
Stainless steel V2A coppered / copper	M6	ø 8 mm / type B	100	111 508

Conductor height Niro-Clip high version type B: 35 mm

Niro-Clip conductor fastener with washer, screw and ø 8 mm dowel.

Type A = fixed conductor leading				
Specification fastener / base	Height	Fit *)	PU	Ord. no.
Stainless steel V2A / stainless steel V2A	18 mm	ø 8 mm / type A	100	111 031
Stainless steel V2A coppered / copper	18 mm	ø 8 mm / type A	100	111 032
Stainless steel V2A / stainless steel V2A	42 mm	ø 8 mm / type A	50	110 500
Stainless steel V2A coppered / copper	42 mm	ø 8 mm / type A	50	110 502

Type B = loose conductor leading				
Specification fastener / base	Height	Fit *)	PU	Ord. no.
Stainless steel V2A / stainless steel V2A	17 mm	ø 8 mm / type B	100	110 080
Stainless steel V2A coppered / copper	17 mm	ø 8 mm / type B	100	110 081
Stainless steel V2A / stainless steel V2A	41 mm	ø 8 mm / type B	50	110 501
Stainless steel V2A coppered / copper	41 mm	ø 8 mm / type B	50	110 503

Niro-Clip cover cap, additional locking and edge protection.

Specification	PU	Ord. no.
Stainless steel V2A	100	111 000
Stainless steel V2A coppered	100	110 999

Niro-Clip opener - to open and loosen the wire from the Niro-Clip. Bending and straightening function for soft materials (e.g. aluminium up to ø 8 mm).

Specification	Weight	Fit	PU	Ord. no.
Niro-Clip opener, polyamide with bi-hexagonal wrench width 13/17	54 g	ø 8 mm	1	110 230

Niro-Clip conductor fastener



Ord. no. 111 501

Niro-Clip conductor fastener



Ord. no. 111 031

Ord. no. 110 502

Niro-Clip cover cap



Ord. no. 111 000

Example of application:



Niro-Clip opener **NEW!**



Ord. no. 110 230

*) **Type A (fl)** = fixed conductor leading; **Type B (ll)** = loose conductor leading



Niro-Clip conductor fastener



Ord. no. 111 003 Ord. no. 111 004

Niro-Clip conductor fastener

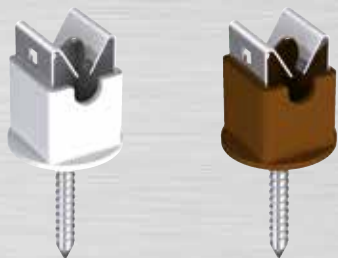

Ord. no. 111 029 Ord. no. 111 030

Screw cap conductor fastener (SK)

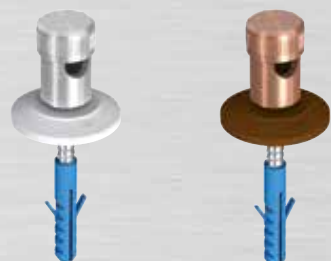

Ord. no. 1010 Ord. no. 1014

Plastic conductor fastener



Ord. no. 1152

Ord. no. 1154

Niro-Clip conductor fastener, for fixing round conductors to walls.

Fastener made of stainless steel V2A, base made of polyamide 6 (PA 6).

Specification fastener / base	Bore / thread	Fit	PU	Ord. no.
Stainless steel V2A / PA 6-base grey	ø 7 mm	ø 8 mm	100	111 003
Stainless steel V2A / PA 6-base brown	ø 7 mm	ø 8 mm	100	111 004
Stainless steel V2A / PA 6-base grey	M6	ø 8 mm	100	111 007

Niro-Clip conductor fastener with screw, base made of polyamide 6 (PA 6).

Specification fastener / base	Height	Fit	PU	Ord. no.
Stainless steel V2A / PA 6 grey	18 mm	ø 8 mm	100	111 029
Stainless steel V2A / PA 6 brown	18 mm	ø 8 mm	100	111 030

Screw cap conductor fastener SK with fastening element and cover rosette, designed for round conductor ø 8 mm for quick and safe wire attachment to walls.

Specification	Height	Fit	PU	Ord. no.
Aluminium	17 mm	ø 8 mm	100	1010
Aluminium	27 mm	ø 8 mm	100	1011
Copper-alloy	17 mm	ø 8 mm	100	1014
Copper-alloy	27 mm	ø 8 mm	100	1015

Also available without screw and dowel.

Plastic conductor fastener -discontinued model- for fixing round conductors to walls. Conductor fastener for low load, made of nylon. Additional ø e.g. 6 or 10 mm on request.

Specification	Height	Fit	PU	Ord. no.
Grey	M6 thread	ø 8 mm	100	1152
Grey	M8 thread	ø 8 mm	100	1153
Copper-coloured	M6 thread	ø 8 mm	100	1158
Copper-coloured	M8 thread	ø 8 mm	100	1159
Grey	M6 thread	ø 8 mm	100	1150
Copper-coloured	M6 thread	ø 8 mm	100	1151
Grey	Dowel 6 x 35 mm	ø 8 mm	100	1154
Grey	Dowel 8 x 35 mm	ø 8 mm	100	1155



Fastener

Specification	Hole spacing	Fit	Material	PU	Ord. no.
with two bore holes elongated hole ø 6.5 x 8.5 mm	28 mm	ø 8-10 mm	Aluminium	100	110 001
	38 mm	ø 8-10 mm	Aluminium	100	110 002
	38 mm	ø 16 mm	Aluminium	100	110 003
	28 mm	ø 8-10 mm	Copper	100	110 004
	38 mm	ø 16 mm	Copper	100	110 005
	28 mm	ø 8-10 mm	Stainless steel V2A	100	110 006
	38 mm	ø 16 mm	Stainless steel V2A	100	110 007
	38 mm	flat 30 mm	Aluminium	100	110 008

Fastener for strip (flat 30 mm), for fixing directly to walls Stainless steel V2A 100 110 015

Specification	Material	PU	Ord. no.
with one bore hole ø 6.5 mm for flush-mounted installation of conductors ø 8 - 11 mm	Stainless steel V2A	100	110 009
	Copper	100	110 010

with plastic dowel (ø 6 mm) for flush-mounted installation of conductors ø 8 - 11 mm Stainless steel V2A 100 110 014

Washers and spacers

Specification	Length	Material	PU	Ord. no.
Washer		Plastic grey	100	1042
Washer		Plastic brown	100	1046
Washer for Niro-Clip		Plastic grey	100	1047
Washer for Niro-Clip		Plastic brown	100	1048
Washer		Stainless steel V2A	100	111 049
Spacer		Plastic grey	100	111 047
Spacer		Plastic brown	100	111 048
Dowel for composite head insulation systems	90 mm	Plastic white	25	110 097
	50 mm	Plastic white	50	110 098

Screws on page 118.

Fastener



Accessories



Wall and roof conductor holders



Conductor fastener



Ord. no. 110 171

Ord. no. 1034

Ord. no. 1132

Conductor fastener



Ord. no. 110 069

Ord. no. 110 160

Ord. no. 1137

Conductor fastener

with loose pin



Ord. no. 110 045

Conductor fastener



Ord. no. 110 099

Ord. no. 110 034

Ord. no. 110 056

Ord. no. 110 038

Conductor fastener for round conductor \varnothing 8-10 mm, mounted with screw M6 V2A, washer or spacer, fastening screw and dowel \varnothing 8 mm.

Specification	Fastener	Inner thread	Height	PU	Ord. no.
Zinc die-cast	Steel, hot galv.	M8	24 mm	100	110 171
Zinc die-cast	Stainless steel V2A	M8	24 mm	100	110 180
Red brass	Copper	M8	24 mm	100	110 172
Steel, hot galv. - plastic	Steel, hot galv.		20 mm	100	1034
Aluminium - plastic	Aluminium		20 mm	100	1033
Copper - plastic	Copper		20 mm	100	1032
Stainless steel V2A - plastic	Stainless steel V2A		20 mm	100	1031
Stainless steel V2A	Stainless steel V2A		15 mm	100	1132

Conductor fastener for round conductor \varnothing 8-10 mm, mounted with screw M6 V2A.

Specification	Fastener	Inner thread	Height	PU	Ord. no.
Zinc die-cast	Steel, hot galvanized	M6	20 mm	100	110 069
Zinc die-cast	Stainless steel V2A	M6	20 mm	100	110 188
Zinc die-cast	Steel, hot galvanized	M8	20 mm	100	110 071
Zinc die-cast	Stainless steel V2A	M8	20 mm	100	110 189
Zinc die-cast with washer	Steel, hot galvanized	M6	23 mm	100	110 160
Zinc die-cast with washer	Stainless steel V2A	M6	23 mm	100	110 190
Zinc die-cast with washer	Steel, hot galvanized	M8	23 mm	100	110 161
Zinc die-cast with washer	Stainless steel V2A	M8	23 mm	100	110 191
Red brass	Copper	M8	20 mm	100	110 072
Stainless steel V2A	Stainless steel V2A	M8	15 mm	100	1137

Conductor fastener with loose pin for round conductor \varnothing 8-10 mm, mounted with screw M6 V2A

Specification	Length	PU	Ord. no.
Aluminium with steel pin	70 mm	100	110 270
Aluminium with steel pin	100 mm	100	110 271
Aluminium with steel pin	150 mm	50	110 272
Steel, hot galvanized with steel pin	70 mm	100	110 050
Steel, hot galvanized with steel pin	100 mm	100	110 045
Steel, hot galvanized with steel pin	150 mm	50	110 047
Stainless steel V2A with stainless steel pin	100 mm	100	110 276
Stainless steel V2A with stainless steel pin	150 mm	50	110 277
Copper with stainless steel pin	100 mm	100	110 280
Copper with stainless steel pin	150 mm	50	110 281

Conductor fastener for insulated walls with insulation thickness of 40-170 mm.

Specification	Insulation thickness	Fit	PU	Ord. no.
Conductor fastener *)				
Niro-Clip stainless steel V2A	up to 60 mm	\varnothing 8 mm /type A	50	110 030
Niro-Clip copper	up to 60 mm	\varnothing 8 mm /type A	50	110 031
Niro-Clip stainless steel V2A	up to 120 mm	\varnothing 8 mm /type A	50	110 056
Niro-Clip stainless steel V2A	up to 170 mm	\varnothing 8 mm /type B	50	110 056 S3
Niro-Clip stainless steel V2A with dowel	min. 50 mm	\varnothing 8 mm /type B	50	110 099
Fastener aluminium	up to 60 mm	\varnothing 8 mm	50	110 034
Fastener aluminium	up to 170 mm	\varnothing 8 mm	50	110 034 S3
Fastener copper	up to 60 mm	\varnothing 8 mm	50	110 035
Rod holder				
Fastener aluminium	up to 60 mm	\varnothing 16 mm	50	110 038
Fastener aluminium	up to 170 mm	\varnothing 16 mm	50	110 038 S1

Fastener for additional insulation thicknesses available on request!

*) **Type A (fl)** = fixed conductor leading; **Type B (ll)** = loose conductor leading



Downpipe conductor fastener with beading for \varnothing 8 mm, to install conductors behind downpipes. **Benefit:** No additional wall fastener required! Fast, clean installation without drilling.

Specification	Diameter of pipe	PU	Ord. no.
With bolt and nut M6			
Steel, hot galvanized	\varnothing 80 mm	25	111 222
Steel, hot galvanized	\varnothing 100 mm	25	111 225
Steel, hot galvanized	\varnothing 120 mm	25	111 227
Copper	\varnothing 80 mm	25	111 232
Copper	\varnothing 100 mm	25	111 235
Copper	\varnothing 120 mm	25	111 237
Aluminium	\varnothing 100 mm	25	111 265
Aluminium	\varnothing 110 mm	25	111 266
Aluminium	\varnothing 120 mm	25	111 267
With bolt M6 and through-hole thread (without nut)			
Steel, hot galvanized	\varnothing 80 mm	25	111 222 G
Steel, hot galvanized	\varnothing 100 mm	25	111 225 G
Steel, hot galvanized	\varnothing 120 mm	25	111 227 G
Copper	\varnothing 80 mm	25	111 232 G
Copper	\varnothing 100 mm	25	111 235 G
Copper	\varnothing 120 mm	25	111 237 G
Aluminium	\varnothing 100 mm	25	111 265 G
Aluminium	\varnothing 110 mm	25	111 266 G
Aluminium	\varnothing 120 mm	25	111 267 G
With snap-mounting			
Steel, hot galvanized	\varnothing 80/90/100/110/120 mm	25	110 255
Aluminium	\varnothing 80/90/100/110/120 mm	25	110 256
Copper	\varnothing 80/90/100/110/120 mm	25	110 257
Stainless steel V2A	\varnothing 80/90/100/110/120 mm	25	110 258

Additional diameters on request!

Universal downpipe conductor fastener, to install conductors behind downpipes. **Benefit:** No additional wall fastener required! Fast, clean installation without drilling.

Specification pipe bracket / tensioning strip	Diameter of pipe	PU	Ord. no.
Stainless steel V2A / stainless steel V2A	\varnothing 60-120 mm	50	110 250
Stainless steel V2A / stainless steel V2A	\varnothing 80-150 mm	50	110 251
Stainless steel V2A / without strip	--	200	110 249
Stainless steel V2A/coppered / Copper-tin-alloy	\varnothing 60-120 mm	50	110 252
Stainless steel V2A/coppered / Copper-tin-alloy	\varnothing 80-150 mm	50	110 253

Stainless steel - tensioning strap in practical cut-to length packaging

Specification	Length	Fit	PU	Ord. no.
Strap stainless steel V2A	25 m	15 x 0.4 mm	1	110 248

Downpipe conductor fastener with beading for \varnothing 8-10 mm, to install conductors behind downpipes. **Benefit:** No additional wall fastener required! Fast, clean installation without drilling.

Specification	Dimensions of pipe	PU	Ord. no.
Steel, hot galvanized	80 x 80 mm	25	911 654
Steel, hot galvanized	100 x 100 mm	25	911 280
Aluminium	80 x 80 mm	25	911 654 S
Aluminium	100 x 100 mm	25	911 280 S
Copper	80 x 80 mm	25	913 610
Copper	100 x 100 mm	25	913 611

Additional dimensions on request.

Conductor fastener for insulated mounting of earth lead-in rods and terminal lugs to the downpipes.

Specification	Fit of holder	PU	Ord. no.
Stainless steel V2A	\varnothing 16 mm	50	111 396
Benefits: universally mountable to the downpipe conductor fasteners with hexagonal screw M8 (e.g. Ord. no. 111 213, 111 120 or 111 391).	\varnothing 10 mm	50	111 397
	fl. 30 mm	50	111 398
	\varnothing 13 mm	50	111 399

Note: For pipe clamps for fixing the conductor fastener to the downpipe on page 88 - 89.

Downpipe conductor fastener with beading

with M6 nut



Ord. no. 111 265

with M6 through-hole thread



Ord. no. 111 225 G

with snap-mounting



Ord. no. 110 256

Universal downpipe conductor fastener



Ord. no. 110 250



Ord. no. 110 249

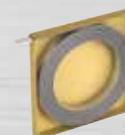

Ord. no. 110 248

Downpipe conductor fastener with beading



Ord. no. 911 280

Conductor fastener



Ord. no. 111 396

Ord. no. 111 398

Example of application:





Rod holder

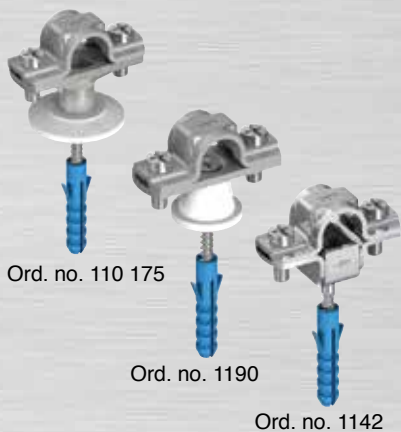

Ord. no. 110 175

Ord. no. 1190

Ord. no. 1142

Rod holder



Ord. no. 110 073

Ord. no. 110 164

Ord. no. 1147

Rod holder

with loose pin



Ord. no. 110 279

Conductor fastener



Ord. no. 110 265

Rod holder for fixing air termination rods and earth lead-in rods, with screws M6 V2A, washer or spacer, fixing screw and dowel ø 8 mm.

Specification	Fastener	Fem. thread	Fit	Height	PU	Ord. no.
Zinc die-cast	Steel, hot galvanized	M8	ø16 mm	24 mm	50	110 175
Zinc die-cast	Stainless steel V2A	M8	ø16 mm	24 mm	50	110 182
Red brass	Copper	M8	ø16 mm	24 mm	50	110 176
Zinc die-cast	Steel, hot galvanized	M8	ø13 mm	24 mm	50	110 187
Zinc die-cast	Stainless steel V2A	M8	ø13 mm	24 mm	100	110 183
Steel, hot galv. -plastic	Steel, hot galvanized		ø16 mm	20 mm	100	1190
Aluminium - plastic	Aluminium		ø16 mm	20 mm	100	1187
Copper - plastic	Copper		ø16 mm	20 mm	100	1188
Stainless steel V2A -plastic	Stainless steel V2A		ø16 mm	20 mm	100	1189
Steel, hot galv. -plastic	Steel, hot galvanized		ø13 mm	20 mm	100	1194
Stainless steel V2A	Stainless steel V2A		ø16 mm	15 mm	100	1142

Rod holder for fixing air termination rods and earth lead-in rods, with screws M6 V2A.

Specification	Fastener	Fem. thread	Fit	Height	PU	Ord. no.
Zinc die-cast	Steel, hot galvanized	M6	ø16 mm	20 mm	100	110 073
Zinc die-cast	Stainless steel V2A	M6	ø16 mm	20 mm	100	110 196
Zinc die-cast	Steel, hot galvanized	M8	ø16 mm	20 mm	100	110 075
Zinc die-cast	Stainless steel V2A	M8	ø16 mm	20 mm	100	110 197
Zinc die-cast with washer	Steel, hot galvanized	M6	ø16 mm	23 mm	100	110 164
Zinc die-cast with washer	Stainless steel V2A	M6	ø16 mm	23 mm	100	110 198
Zinc die-cast with washer	Steel, hot galvanized	M8	ø16 mm	23 mm	100	110 165
Zinc die-cast with washer	Stainless steel V2A	M8	ø16 mm	23 mm	100	110 199
Red brass	Copper	M8	ø16 mm	20 mm	100	110 076
Zinc die-cast	Steel, hot galvanized	M8	ø13 mm	20 mm	100	110 087
Zinc die-cast	Stainless steel V2A	M8	ø13 mm	20 mm	100	110 179
Stainless steel V2A	Stainless steel V2A	M8	ø16 mm	15 mm	100	1147

Rod holder with loose pin, for fixing air termination rods and earth lead-in rods, mounted with screws M6 V2A.

Specification	Fit	Length	PU	Ord. no.
Steel, hot galvanized with steel pin	ø16 mm	100 mm	100	110 046
Steel, hot galvanized with steel pin	ø16 mm	150 mm	50	110 048
Stainless steel V2A mit stainless steel pin	ø16 mm	100 mm	100	110 278
Stainless steel V2A mit stainless steel pin	ø16 mm	150 mm	50	110 279
Copper with stainless steel pin	ø16 mm	100 mm	100	110 282
Copper with stainless steel pin	ø16 mm	150 mm	50	110 283

Conductor fastener for fixing cables ø 10.5 - 14 mm, with button head screw V2A and ø 8 mm dowel.

Specification	Fit	PU	Ord. no.
Stainless steel V2A	ø 10.5 - 14 mm	100	110 265



Tape conductor holder for 30 mm wide flat strips.

Benefit: less work - insert the strip, bend the lug - ready

Specification	Fit	PU	Ord. no.
Stainless steel V2A with screw and dowel ø 8 mm	fl. 30 mm	100	1178
Stainless steel V2A	fl. 30 mm	100	1178 S

Example of application:



Tape conductor holder for 30 mm wide flat strip, with screws M6 V2A, washer or base, fixing screw and dowel ø 8 mm.

Specification	Fastener	Fem. thread	Height	PU	Ord. no.
Zinc die-cast	Steel, hot galvanized	M8	24 mm	100	110 178
Zinc die-cast	Stainless steel V2A	M8	24 mm	100	110 181
Steel, hot galvanized - plastic	Steel, hot galvanized		20 mm	100	1183
Aluminium - plastic	Aluminium		20 mm	100	1185
Stainless steel V2A - plastic	Stainless steel V2A		20 mm	100	1184
Stainless steel V2A	Stainless steel V2A		15 mm	100	1121

For 40 mm wide flat strips on request.

Tape conductor holder for 30 mm wide flat strip, with screws M6 V2A.

Specification	Fastener	Fem. thread	Height	PU	Ord. no.
Zinc die-cast	Steel, hot galvanized	M6	20 mm	100	110 077
Zinc die-cast	Steel, hot galvanized	M8	20 mm	100	110 078
Zinc die-cast with base	Steel, hot galvanized	M6	23 mm	100	110 162
Zinc die-cast with base	Stainless steel V2A	M6	23 mm	100	110 194
Zinc die-cast with base	Steel, hot galvanized	M8	23 mm	100	110 163
Zinc die-cast with base	Stainless steel V2A	M8	23 mm	100	110 195
Stainless steel V2A	Stainless steel V2A	M8	15 mm	100	1128

For 40 mm wide flat strips on request.

Tape conductor holder with button head screw V2A and dowel ø 8 mm.

Specification	Height	Fit	PU	Ord. no.
Steel, hot galvanized	15 mm	fl. 30 mm	100	1180
Steel, hot galvanized	15 mm	fl. 40 mm	100	2037
Copper	15 mm	fl. 30 mm	100	1182
Copper	15 mm	fl. 40 mm	100	2039
Stainless steel V2A	15 mm	fl. 30 mm	100	1181

Tape conductor holder for wall mounting, with screw M8 and clamping bracket.

Specification	Slot width	Distance to wall	PU	Ord. no.
Steel, hot galvanized	10 mm	18 mm	50	911 314
Copper	10 mm	18 mm	50	911 576
Stainless steel V2A	10 mm	18 mm	50	911 575

Tape conductor holder (J&P patent)

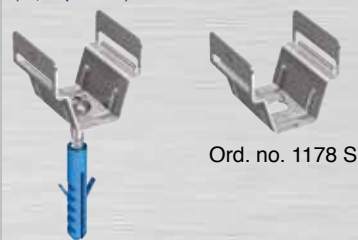

Ord. no. 1178 S

Ord. no. 1178

Tape conductor holder

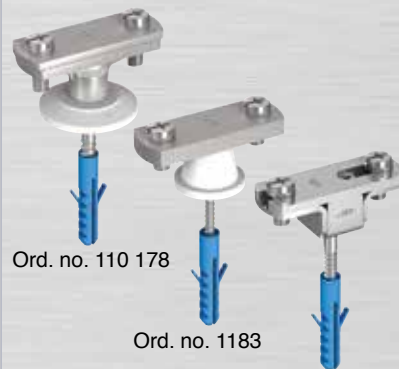

Ord. no. 110 178

Ord. no. 1183

Ord. no. 1121

Tape conductor holder



Ord. no. 110 077

Ord. no. 110 162

Ord. no. 1128

Tape conductor holder



Ord. no. 1181

Tape conductor holder



Ord. no. 911 314



Roof conductor holder with clamping bracket & Niro-Clip



Ord. no. 111 010



Ord. no. 111 525

PRÖ COLOR

Roof conductor holder with clamping bracket & Niro-Clip



Ord. no. 111 010 az



Ord. no. 111 525 ro

Roof conductor holder



Ord. no. 1021



Ord. no. 1028



Ord. no. 110 517

Roof conductor holder system Niro-Clip

Roof conductor holder with clamping bracket, for bitumen shingles and slate roofs or for tiles with large clamping range.

Specification	Fixed conductor leading	Clamp. range	Fit	PU	Ord. no.
Base	Niro-Clip type A				
Stainless steel V2A	Stainless steel V2A	up to 5 mm	ø 8 mm	100	111 010
Stainless steel V2A	Stainless steel V2A	up to 18 mm	ø 8 mm	100	111 525
Copper	Stainless steel /coppered	up to 5 mm	ø 8 mm	100	111 012
Copper	Stainless steel /coppered	up to 18 mm	ø 8 mm	100	111 526

Specification	Loose conductor leading	Clamp. range	Fit	PU	Ord. no.
Base	Niro-Clip type B				
Stainless steel V2A	Stainless steel V2A	up to 5 mm	ø 8 mm	100	111 011
Stainless steel V2A	Stainless steel V2A	up to 18 mm	ø 8 mm	100	111 527
Copper	Stainless steel /coppered	up to 5 mm	ø 8 mm	100	111 013
Copper	Stainless steel /coppered	up to 18 mm	ø 8 mm	100	111 528

PRÖ-COLOR Roof conductor holder

for bitumen shingles and slate roofs or for tiles with large clamping range.

Specification	Fixed conductor leading	Clamp. range	Fit	PU	Ord. no.
Base	Niro-Clip type A				
Steel, hot galv. /coated	Stainless steel V2A	up to 5 mm	ø 8 mm	100	111 010 az
Steel, hot galv. /coated	Stainless steel V2A	up to 18 mm	ø 8 mm	100	111 525 ro
Steel, hot galv. /coated	Stainless steel V2A	up to 18 mm	ø 8 mm	100	111 525 az

Specification	Loose conductor leading	Clamp. range	Fit	PU	Ord. no.
Base	Niro-Clip type B				
Steel, hot galv. /coated	Stainless steel V2A	up to 5 mm	ø 8 mm	100	111 011 az
Steel, hot galv. /coated	Stainless steel V2A	up to 18 mm	ø 8 mm	100	111 527 ro
Steel, hot galv. /coated	Stainless steel V2A	up to 18 mm	ø 8 mm	100	111 527 az

Specifications: ● ro - colour of the conductor holder: red brown
● az - colour of the conductor holder: anthracite

Roof conductor holder suitable for all tile shapes; for ø 8 mm round conductor; to be used on the ridge and the roof surface, bore hole ø 12 mm.

Specification	Fastener *)	Height	Fit	PU	Ord. no.
Bottom part	SK holder aluminium	29 mm	ø 8 mm	100	1021
Grommet (TPE-soft)	Niro-Clip stainless steel/ type A	23 mm	ø 8 mm	100	1028
Grommet (TPE-soft)	Niro-Clip stainless steel/ type B	22 mm	ø 8 mm	100	1027
Grommet (TPE-soft)	Niro-Clip coppered/ type A	23 mm	ø 8 mm	100	1029
Grommet (TPE-soft)	Niro-Clip stainless steel/ type A	44 mm	ø 8 mm	50	110 517
Grommet (TPE-soft)	Niro-Clip stainless steel/ type B	43 mm	ø 8 mm	50	110 518
Grommet (TPE-soft)	Niro-Clip coppered/ type A	44 mm	ø 8 mm	50	110 519

*) **Type A (fl)** = fixed conductor leading; **Type B (ll)** = loose conductor leading

Roof conductor holder with clamping bracket

(clamping range up to 5 mm) for slate roofs; especially well-suited for later installation!

Specification	Fixed conductor leading	Length	Fit	PU	Ord. no.
Base	Niro-Clip type A				
Stainless steel V2A with teeth	Stainless steel V2A	180 mm	ø 8 mm	200	111 033
Stainless steel V2A without teeth	Stainless steel V2A	180 mm	ø 8 mm	200	111 512
Copper with teeth	Stainless steel/CC	180 mm	ø 8 mm	200	111 035
Specification	Loose conductor leading	Length	Fit	PU	Ord. no.
Base	Niro-Clip type B				
Stainless steel V2A with teeth	Stainless steel V2A	180 mm	ø 8 mm	200	111 511
Stainless steel V2A without teeth	Stainless steel V2A	180 mm	ø 8 mm	200	111 513
Copper with teeth	Stainless steel/CC	180 mm	ø 8 mm	200	111 516

PRÖ-COLOR Roof conductor holder (clamping range up to 5 mm)

for slate roofs; especially well-suited for later installation!

Specification	Niro-Clip V2A	Length	Fit	PU	Ord. no.
Base	Type A - fixed conductor leading				
Steel, hot galvanized/coated with teeth	Type A - fixed conductor leading	180 mm	ø 8 mm	200	111 033 az
Steel, hot galvanized/coated with teeth	Type B - loose conductor leading	180 mm	ø 8 mm	200	111 511 az

Specification: ● az - color of the conductor holder in anthracite

Roof conductor holder, for direct clamping

to flat roof tiles, sheets and ridge tiles. **Clamping range 9-15 mm**, clamp by twisting holder.

Specification	Fixed conductor leading	Height	Fit	PU	Ord. no.
Base	Niro-Clip type A				
Stainless steel V2A	Stainless steel V2A	30 mm	ø 8 mm	50	111 550
Copper	Stainless steel /coppered	30 mm	ø 8 mm	50	111 552
Stainless steel V2A	Stainless steel V2A	52 mm	ø 8 mm	50	110 509
Copper	Stainless steel /coppered	52 mm	ø 8 mm	50	110 511
Specification	Loose conductor leading	Height	Fit	PU	Ord. no.
Base	Niro-Clip type B				
Stainless steel V2A	Stainless steel V2A	29 mm	ø 8 mm	50	111 551
Copper	Stainless steel /coppered	29 mm	ø 8 mm	50	111 553
Stainless steel V2A	Stainless steel V2A	51 mm	ø 8 mm	50	110 510
Copper	Stainless steel /coppered	51 mm	ø 8 mm	50	110 512

Conductor fastener

for universal use, with standing seam clamp, **clamping range 1-8 mm**.

Specification	Niro-Clip *)	Fit	PU	Ord. no.
Bottom part	Niro-Clip *)			
Steel, hot galvanized	Stainless steel V2A/ type B	ø 8 mm	50	913 732
Copper	Stainless steel V2A/coppered / type B	ø 8 mm	50	913 733
Stainless steel V2A	Stainless steel V2A/ type B	ø 8 mm	50	913 734
Aluminium	Stainless steel V2A/ type B	ø 8 mm	50	913 420

*) **Type A (fl)** = fixed conductor leading; **Type B (ll)** = loose conductor leading

Roof conductor holder with clamping bracket & Niro-Clip



Ord. no. 111 033

PRÖ COLOR

Roof conductor holder with clamping bracket & Niro-Clip



Ord. no. 111 033 az

Roof conductor holder with Niro-Clip



Ord. no. 111 550

Ord. no. 110 509

Conductor fastener with Niro-Clip



Ord. no. 913 420



Roof conductor holder



Ord. no. 111 019

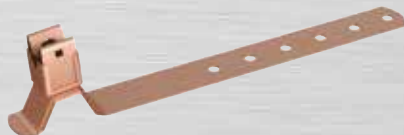

Ord. no. 111 020

PRÖ COLOR

Roof conductor holder with Niro-Clip



Ord. no. 111 019 az



Ord. no. 111 019 ro

J.Pröpster patented Roof conductor holder (JIP patent)



Ord. no. 111 051



Ord. no. 111 052

Roof conductor holder with screw fastening



Ord. no. 1062

Roof conductor holder for universal use.

Specification	Type A Fixed conductor leading	Length	Fit	PU	Ord. no.
Bottom part	Niro-Clip				
Stainless steel V2A	Stainless steel V2A	210 mm	ø 8 mm	100	111 019
Stainless steel V2A	Stainless steel V2A	280 mm	ø 8 mm	100	111 015
Stainless steel V2A	Stainless steel V2A	410 mm	ø 8 mm	50	111 535
Copper	Stainless steel V2A/coppered	210 mm	ø 8 mm	100	111 020
Copper	Stainless steel V2A/coppered	280 mm	ø 8 mm	100	111 016
Copper	Stainless steel V2A/coppered	410 mm	ø 8 mm	50	111 537
Specification	Type B Loose conductor leading	Length	Fit	PU	Ord. no.
Bottom part	Niro-Clip				
Stainless steel V2A	Stainless steel V2A	210 mm	ø 8 mm	100	111 540
Stainless steel V2A	Stainless steel V2A	280 mm	ø 8 mm	100	111 541
Stainless steel V2A	Stainless steel V2A	410 mm	ø 8 mm	50	111 536
Copper	Stainless steel V2A/coppered	210 mm	ø 8 mm	100	111 545
Copper	Stainless steel V2A/coppered	280 mm	ø 8 mm	100	111 546

PRÖ-COLOR Roof conductor holder for universal use.

Specification	Type A Fixed conductor leading	Length	Fit	PU	Ord. no.
Bottom part	Niro-Clip				
Steel, hot galvanized/coated	Stainless steel V2A	210 mm	ø 8 mm	100	111 019 az
Steel, hot galvanized/coated	Stainless steel V2A	280 mm	ø 8 mm	100	111 015 az
Steel, hot galvanized/coated	Stainless steel V2A	210 mm	ø 8 mm	100	111 019 ro
Steel, hot galvanized/coated	Stainless steel V2A	280 mm	ø 8 mm	100	111 015 ro
Specification	Type B Loose conductor leading	Length	Fit	PU	Ord. no.
Bottom part	Niro-Clip				
Steel, hot galvanized/coated	Stainless steel V2A	210 mm	ø 8 mm	100	111 540 az
Steel, hot galvanized/coated	Stainless steel V2A	280 mm	ø 8 mm	100	111 541 az
Steel, hot galvanized/coated	Stainless steel V2A	210 mm	ø 8 mm	100	111 540 ro
Steel, hot galvanized/coated	Stainless steel V2A	280 mm	ø 8 mm	100	111 541 ro

Specifications: ● ro - colour of the conductor holder: red brown
● az - colour of the conductor holder: anthracite

Roof conductor holder for universal use. Benefits: one piece, no screws or plastic parts! Quick and easy installation! Made of corrosion resistant stainless steel!

Specification	Length	Fit	PU	Ord. no.
Stainless steel V2A	210 mm	ø 8 mm	200	111 050
Stainless steel V2A	280 mm	ø 8 mm	200	111 051
Stainless steel V2A	110 mm angled	ø 8 mm	200	111 052

Roof conductor holder for universal use. Support riveted to holder.

Specification	Length	Fit	PU	Ord. no.
Stainless steel V2A	210 mm	ø 8 mm	100	1062
with screw fastening in aluminium	280 mm	ø 8 mm	100	1063
	410 mm	ø 8 mm	50	1064
Copper with screw fastening	210 mm	ø 8 mm	100	1065
	280 mm	ø 8 mm	100	1066
	410 mm	ø 8 mm	50	1067

*) **Type A (fl)** = fixed conductor leading; **Type B (ll)** = loose conductor leading



Roof conductor holder for pantiled roofs.

Specification	Type A Fixed conductor leading	Length	Fit	PU	Ord. no.
Bottom part	Niro-Clip				
Stainless steel V2A	Stainless steel V2A	120 mm	ø 8 mm	150	111 023
Copper	Stainless steel V2A/coppered	120 mm	ø 8 mm	150	111 024
Specification	Type B Loose conductor leading	Length	Fit	PU	Ord. no.
Bottom part	Niro-Clip				
Stainless steel V2A	Stainless steel V2A	120 mm	ø 8 mm	150	111 530
Copper	Stainless steel V2A/coppered	120 mm	ø 8 mm	150	111 532

Roof conductor holder with Niro-Clip



Ord. no. 111 023

PRÖ-COLOR Roof conductor holder for pantiled roofs.

Specification	Type A Fixed conductor leading	Length	Fit	PU	Ord. no.
Bottom part	Niro-Clip				
Steel, hot galvanized/coated	Stainless steel V2A	120 mm	ø 8 mm	150	111 023 az
Steel, hot galvanized/coated	Stainless steel V2A	120 mm	ø 8 mm	150	111 023 ro
Specification	Type B Loose conductor leading	Length	Fit	PU	Ord. no.
Bottom part	Niro-Clip				
Steel, hot galvanized/coated	Stainless steel V2A	120 mm	ø 8 mm	150	111 530 az
Steel, hot galvanized/coated	Stainless steel V2A	120 mm	ø 8 mm	150	111 530 ro

Specifications: ● ro - colour of the conductor holder: red brown
● az - colour of the conductor holder: anthracite

PRÖ COLOR

Roof conductor holder with Niro-Clip

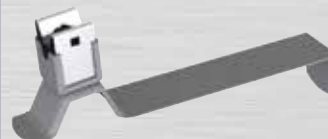

Ord. no. 111 023 az



Ord. no. 111 023 ro

Roof conductor holder for easy fitting; simply insert in seam, exert pressure and the support moulds itself to the seam. Aluminium type with stainless steel reinforced trapezoidal section.

Specification	Type A Fixed conductor leading	Length	Fit	PU	Ord. no.
Bottom part	Niro-Clip				
Aluminium	Stainless steel V2A	120 mm	ø 8 mm	150	111 043
Copper	Stainless steel V2A/coppered	120 mm	ø 8 mm	150	111 044
Aluminium	Stainless steel V2A	170 mm	ø 8 mm	100	111 057
Copper	Stainless steel V2A/coppered	170 mm	ø 8 mm	100	111 058
Specification	Type B Loose conductor leading	Length	Fit	PU	Ord. no.
Bottom part	Niro-Clip				
Aluminium	Stainless steel V2A	120 mm	ø 8 mm	150	111 043 S
Copper	Stainless steel V2A/coppered	120 mm	ø 8 mm	150	111 044 S
Aluminium	Stainless steel V2A	170 mm	ø 8 mm	100	111 057 S
Copper	Stainless steel V2A/coppered	170 mm	ø 8 mm	100	111 058 S

Roof conductor holder for interlocking tiles



Ord. no. 111 043

Roof conductor holder for hocking into "ergoldsbacher" interlocking tiles

Specification	Type A Fixed conductor leading	Fit	PU	Ord. no.
Bottom part	Niro-Clip			
Stainless steel V2A	Stainless steel V2A	ø 8 mm	150	111 157
Copper	Stainless steel V2A/coppered	ø 8 mm	150	111 158

Roof conductor holder for interlocking tiles



Ord. no. 111 157

*) **Type A (fl)** = fixed conductor leading; **Type B (ll)** = loose conductor leading



Roof conductor holder with Niro-Clip



Ord. no. 111 027



Ord. no. 111 037

Roof conductor holder with Niro-Clip



Ord. no. 110 515



Ord. no. 111 451

Roof conductor holder with Niro-Clip



Ord. no. 1095

Roof conductor holder with Niro-Clip



Ord. no. 1088

Roof conductor holder with Niro-Clip

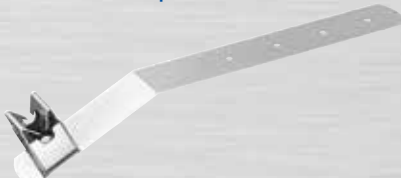

Ord. no. 111 150

Roof conductor holder for corrugated sheet roofs, for installing round conductors, lengthwise and crosswise conductor leading

Specification	Height	Fit	PU	Ord. no.
Bottom part Niro-Clip stainless steel				
Stainless steel V2A Type A fixed conductor leading	18 mm	ø 8 mm	100	111 027
Stainless steel V2A Type B loose conductor leading	17 mm	ø 8 mm	100	111 045

With high version of Niro-Clip on request.

Roof conductor holder for corrugated sheet roofs, for installing round conductors, lengthwise and crosswise conductor leading with fixing bore ø 6.5 mm

Specification	Height	Fit	PU	Ord. no.
Bottom part Niro-Clip stainless steel				
Stainless steel V2A Type A fixed conductor leading	18 mm	ø 8 mm	100	111 037
Stainless steel V2A Type B loose conductor leading	17 mm	ø 8 mm	100	111 039

Roof conductor holder for hooking into interlocking tiles.

Specification	Type A Fixed conductor leading	Height	Fit	PU	Ord. no.
Bottom part Niro-Clip					
Stainless steel V2A	Stainless steel V2A	18 mm	ø 8 mm	100	111 455
Stainless steel V2A	Stainless steel V2A	39 mm	ø 8 mm	50	110 515
Stainless steel V2A	Stainless steel V2A	48 mm	ø 8 mm	100	111 451
Copper	Stainless steel V2A/coppered	48 mm	ø 8 mm	100	111 452
Bottom part Niro-Clip					
Stainless steel V2A	Stainless steel V2A	47 mm	ø 8 mm	100	111 453
Copper	Stainless steel V2A/coppered	47 mm	ø 8 mm	100	111 454

Roof conductor holder as intermediate support for installing round conductors to corrugated sheet roofs.

Specification	Fit	PU	Ord. no.
Bottom part Niro-Clip stainless steel V2A			
Stainless steel V2A Type A fixed conductor leading	ø 8 mm	100	1095

With high version of Niro-Clip on request.

Roof conductor holder for corrugated sheet roofs; for installing in the valley of corrugation of corrugated sheet roofs.

Specification	Fit	PU	Ord. no.
Bottom part Niro-Clip stainless steel V2A			
Stainless steel V2A Type A fixed conductor leading	ø 8 mm	100	1088

Roof conductor holder for slate and bitumen roofs

Specification	Fit	PU	Ord. no.
Bottom part Niro-Clip stainless steel V2A			
Stainless steel V2A Type A fixed conductor leading	ø 8 mm	100	111 150
Stainless steel V2A Type B loose conductor leading	ø 8 mm	100	111 153

*) **Type A (fl)** = fixed conductor leading; **Type B (ll)** = loose conductor leading

Roof conductor holder for Kalzip, for installing round conductors to Kalzip roof systems (conductor leading lengthwise and crosswise).

Specification		Fit	PU	Ord. no.
Bottom part	Niro-Clip *)			
Stainless steel V2A	Stainless steel type B; crosswise to bead	ø 8 mm	100	111 750
Stainless steel V2A	Stainless steel type B; lengthwise to bead	ø 8 mm	100	111 750 S

Roof conductor holder for Kalzip, with Niro-Clip (J&P patent)

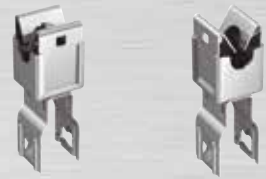

Ord. no. 111 750

Ord. no. 111 750 S

Roof conductor holder for Kalzip, for installing round conductors to Kalzip roof systems (conductor leading lengthwise and crosswise).

Specification		Fit	PU	Ord. no.
Bottom part	Fastener *)			
Aluminium	Niro-Clip stainless steel V2A/ type A	ø 8 mm	25	1309
Aluminium	Niro-Clip stainless steel V2A/ type B	ø 8 mm	25	913 615
Stainless steel V2A	Niro-Clip stainless steel V2A/ type A	ø 8 mm	25	913 616
Stainless steel V2A	Niro-Clip stainless steel V2A/ type B	ø 8 mm	25	913 617
Aluminium	Double terminal clamp V2A	ø 6-8 mm	25	1309 S
Stainless steel V2A	Double terminal clamp V2A	ø 6-8 mm	25	1308 S

Roof conductor holder for Kalzip



Ord. no. 1309

Ord. no. 1309 S

Roof conductor holder for RIB-ROOF 500, for installing round conductors to Rib-Roof 500 roof systems (conductor leading lengthwise and crosswise).

Specification		Fit	PU	Ord. no.
Bottom part	Niro-Clip *)			
Stainless steel V2A	Stainless steel type B; crosswise to bead	ø 8 mm	100	111 760
Stainless steel V2A	Stainless steel type B; lengthwise to bead	ø 8 mm	100	111 761

Roof conductor holder for RIB-Roof 500, with Niro-Clip (J&P patent)



Ord. no. 111 760

Ord. no. 111 761

Roof conductor holder for RIB-ROOF 500, for installing round conductors to RIB-ROOF 500 roof systems (conductor leading lengthwise and crosswise).

Specification		Fit	PU	Ord. no.
Bottom part	Fastener *)			
Aluminium	Niro-Clip stainless steel V2A/ type A	ø 8 mm	25	111 764
Stainless steel V2A	Niro-Clip stainless steel V2A/ type A	ø 8 mm	25	111 765
Aluminium	Niro-Clip stainless steel V2A/ type B	ø 8 mm	25	111 766
Stainless steel V2A	Niro-Clip stainless steel V2A/ type B	ø 8 mm	25	111 767
Aluminium	Double terminal clamp V2A	ø 6-8 mm	25	111 768
Stainless steel V2A	Double terminal clamp V2A	ø 6-8 mm	25	111 769

Roof conductor holder for RIB-Roof 500, with Niro-Clip



Ord. no. 111 764

Ord. no. 111 768

*) **Type A (fl)** = fixed conductor leading; **Type B (ll)** = loose conductor leading



Roof conductor holder with Niro-Clip



Ord. no. 111 144

Ord. no. 110 520



Ord. no. 111 145

Ord. no. 110 522

PRÖ COLOR

Roof conductor holder with Niro-Clip



Ord. no. 111 144 az



Ord. no. 111 144 ro

Roof conductor holder



Ord. no. 111 132

Ord. no. 111 141

Roof conductor holder suitable for ridge tiles of all sizes
- universally adjustable installing round conductors. **Benefit:** one type fits all!

Specification	Type A Fixed conductor leading	Height	Fit	PU	Ord. no.
Bottom part	Niro-Clip				
Stainless steel V2A	Stainless steel V2A	17 mm	ø 8 mm	100	111 144
Copper	Stainless steel V2A/coppered	17 mm	ø 8 mm	100	111 145
Stainless steel V2A	Stainless steel V2A	38 mm	ø 8 mm	50	110 520
Copper	Stainless steel V2A/coppered	38 mm	ø 8 mm	50	110 522

Specification	Type B Loose conductor leading	Height	Fit	PU	Ord. no.
Bottom part	Niro-Clip				
Stainless steel V2A	Stainless steel V2A	16 mm	ø 8 mm	100	111 136
Copper	Stainless steel V2A/coppered	16 mm	ø 8 mm	100	111 137
Stainless steel V2A	Stainless steel V2A	37 mm	ø 8 mm	50	110 521
Copper	Stainless steel V2A/coppered	37 mm	ø 8 mm	50	110 523

PRÖ-COLOR Roof conductor holder suitable for ridge tiles of all sizes
- universally adjustable installing round conductors. **Benefit:** one type fits all!

Specification	Type A Fixed conductor leading	Height	Fit	PU	Ord. no.
Bottom part	Niro-Clip				
Steel, hot galvanized/coated	Stainless steel V2A	17 mm	ø 8 mm	100	111 144 az
Steel, hot galvanized/coated	Stainless steel V2A	17 mm	ø 8 mm	100	111 144 ro
Specification	Type B Loose conductor leading	Height	Fit	PU	Ord. no.
Bottom part	Niro-Clip				
Steel, hot galvanized/coated	Stainless steel V2A	16 mm	ø 8 mm	100	111 136 az
Steel, hot galvanized/coated	Stainless steel V2A	16 mm	ø 8 mm	100	111 136 ro

Specifications: ● ro - colour of the conductor holder: red brown
● az - colour of the conductor holder: anthracite

Roof conductor holder suitable for ridge tiles of all sizes
- universally adjustable installing round conductors. **Benefit:** one type fits all!

Specification	Fit	PU	Ord. no.
Stainless steel V2A	ø 8-10 mm	100	111 140
Copper	ø 8 mm	100	111 141
Bottom part	Niro-Clip		
Stainless steel V2A	Type A fixed conductor leading	ø 8 mm	100
Stainless steel V2A	Type B loose conductor leading	ø 8 mm	100
Copper	Type A fixed conductor leading	ø 8 mm	100
Copper	Type B loose conductor leading	ø 8 mm	100





*) **Type A (fl)** = fixed conductor leading; **Type B (ll)** = loose conductor leading









Roof conductor holder with springs

Universal use for the roof ridge.

Roof conductor holder with 2 tension springs made of stainless steel and wire hook for permanent and fast installation on the roof ridge - with lateral conductor leading. Suitable for ridge tiles of all sizes.

Specification	Type A fixed cond. leading	Height	Fit	PU	Ord. no.
Bottom part	Niro-Clip lateral				
Stainless steel V2A	Stainless steel V2A	37 mm	ø 8 mm	25	111 191 
Stainless steel / coppered	Stainless steel / coppered	37 mm	ø 8 mm	25	111 196 
Stainless steel V2A	Stainless steel V2A	58 mm	ø 8 mm	25	110 524 
Stainless steel / coppered	Stainless steel / coppered	58 mm	ø 8 mm	25	110 526 
Specification	Type B loose cond. leading	Height	Fit	PU	Ord. no.
Bottom part	Niro-Clip lateral				
Stainless steel V2A	Stainless steel V2A	36 mm	ø 8 mm	25	111 175 
Stainless steel / coppered	Stainless steel / coppered	36 mm	ø 8 mm	25	111 176 
Stainless steel V2A	Stainless steel V2A	57 mm	ø 8 mm	25	110 525 
Stainless steel / coppered	Stainless steel / coppered	57 mm	ø 8 mm	25	110 527 



Roof conductor holder with 2 tension springs made of stainless steel and second flat hook for permanent and fast installation on the roof ridge - with lateral conductor leading. Suitable for ridge tiles of all sizes.

Specification	Type A fixed cond. leading	Height	Fit	PU	Ord. no.
Bottom part	Niro-Clip lateral				
Stainless steel V2A	Stainless steel V2A	37 mm	ø 8 mm	25	110 538 
Stainless steel / coppered	Stainless steel / coppered	37 mm	ø 8 mm	25	110 542 
Stainless steel V2A	Stainless steel V2A	58 mm	ø 8 mm	25	110 539 
Stainless steel / coppered	Stainless steel / coppered	58 mm	ø 8 mm	25	110 543 
Specification	Type B loose cond. leading	Height	Fit	PU	Ord. no.
Bottom part	Niro-Clip lateral				
Stainless steel V2A	Stainless steel V2A	36 mm	ø 8 mm	25	110 540 
Stainless steel / coppered	Stainless steel / coppered	36 mm	ø 8 mm	25	110 544 
Stainless steel V2A	Stainless steel V2A	57 mm	ø 8 mm	25	110 541 
Stainless steel / coppered	Stainless steel / coppered	57 mm	ø 8 mm	25	110 545 

Roof conductor holder with 2 tension springs made of stainless steel and wire hook for permanent and fast installation on the roof ridge - with central conductor leading. Suitable for ridge tiles of all sizes.

Specification	Type A fixed cond. leading	Height	Fit	PU	Ord. no.
Bottom part	Niro-Clip central				
Stainless steel V2A	Stainless steel V2A	39 mm	ø 8 mm	25	111 192 
Stainless steel / coppered	Stainless steel / coppered	39 mm	ø 8 mm	25	111 197 
Stainless steel V2A	Stainless steel V2A	61 mm	ø 8 mm	25	110 528 
Stainless steel / coppered	Stainless steel / coppered	61 mm	ø 8 mm	25	110 530 
Specification	Type B loose cond. leading	Height	Fit	PU	Ord. no.
Bottom part	Niro-Clip central				
Stainless steel V2A	Stainless steel V2A	38 mm	ø 8 mm	25	111 177 
Stainless steel / coppered	Stainless steel / coppered	38 mm	ø 8 mm	25	111 178 
Stainless steel V2A	Stainless steel V2A	60 mm	ø 8 mm	25	110 529 
Stainless steel / coppered	Stainless steel / coppered	60 mm	ø 8 mm	25	110 531 

Roof conductor holder with 2 tension springs made of stainless steel and second flat hook for permanent and fast installation on the roof ridge - with central conductor leading. Suitable for ridge tiles of all sizes.

Specification	Type A fixed cond. leading	Height	Fit	PU	Ord. no.
Bottom part	Niro-Clip central				
Stainless steel V2A	Stainless steel V2A	39 mm	ø 8 mm	25	110 547 
Specification	Type B loose cond. leading	Height	Fit	PU	Ord. no.
Bottom part	Niro-Clip central				
Stainless steel V2A	Stainless steel V2A	38 mm	ø 8 mm	25	110 546 

Roof conductor holder with Niro-Clip (with lateral conductor leading) (J&P patent)

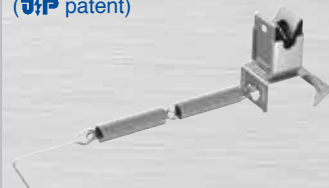

Ord. no. 111 191

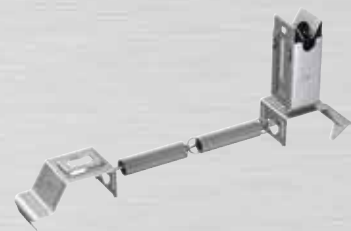

Ord. no. 110 539

Roof conductor holder with Niro-Clip (with central conductor leading) (J&P patent)

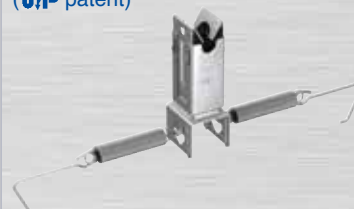

Ord. no. 110 528



Ord. no. 110 546

Wall and roof conductor holders

*) **Type A (fl)** = fixed conductor leading; **Type B (ll)** = loose conductor leading



Roof conductor holder for synthetic roofing membranes

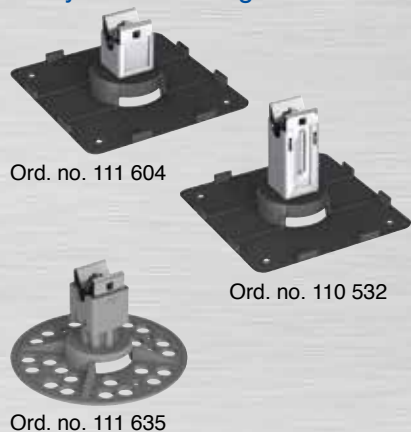

Ord. no. 111 604

Ord. no. 110 532

Ord. no. 111 635

Roof conductor holder with Niro-Clip

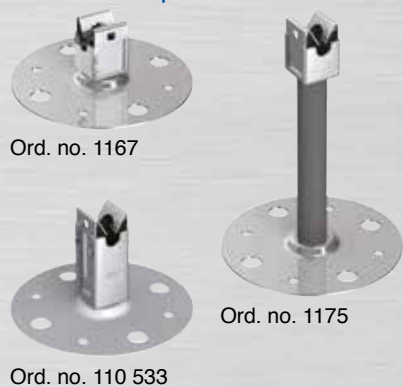

Ord. no. 1167

Ord. no. 1175

Ord. no. 110 533

Roof conductor holder with Niro-Clip



Ord. no. 111 661

Ord. no. 111 631

Roof conductor holder for synthetic roofing membranes and bitumen roofs. To be fixed onto synthetic roofing membranes with weldable fastening strips; glued directly onto bitumen roofs (PA 6 = polyamide 6).

Specification		Height	Fit	PU	Ord. no.
Bottom part	Niro-Clip *)				
Plastic	Stainless steel V2A /type B	30 mm	ø 8 mm	100	111 604
Plastic	Stainless steel V2A /type B	51 mm	ø 8 mm	50	110 532
Plastic PA 6 round for bitumen roofs	Stainless steel V2A with PA 6 base grey	41 mm	ø 8 mm	100	111 635

Upon request, the base can also be equipped with other conductor holders.

Example of application:

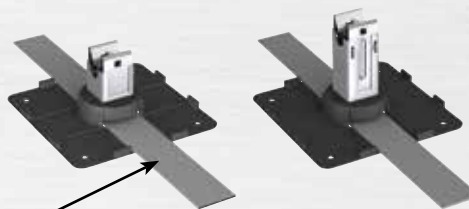

Fastening strip crosswise to conductor leading.

Roof conductor holder for bitumen sheet roofs, flat roofs and walls. (PA 6=polyamide 6) Holder with a height of 100 mm (No. 1175) for fixing the conductor onto flammable material.

Specification		Height	Fit	PU	Ord. no.
Plate	Niro-Clip *)				
Stainless steel V2A	Stainless steel V2A type A	21 mm	ø 8 mm	100	1167
Stainless steel V2A	Stainless steel V2A type A	43 mm	ø 8 mm	50	110 533
Stainless steel V2A	Stainless steel V2A type A	121 mm	ø 8 mm	50	1175

Additional types on request.

Roof conductor holder for metal roofs and surfaces with adhesive pad: simply remove protective film and stick on.

Specification		Height	Fit	PU	Ord. no.
Support with	Niro-Clip *)				
Adhesive pad aluminium	Stainless steel type B	21 mm	ø 8 mm	100	111 661
Adhesive pad grey	Stainless steel type B	23 mm	ø 8 mm	100	111 662
Adhesive pad aluminium	Stainless steel type B	43 mm	ø 8 mm	50	111 631
Adhesive pad grey	Stainless steel type B	45 mm	ø 8 mm	50	111 632

Surfaces suitable for installation:

- Metal surfaces (e.g. Stainless steel, steel, aluminium)
- glass
- many plastics (e.g. hard PVC, ABS, PC, PE, PP)
- coated smooth surfaces
- ceramics
- powder coats

In case of any doubt with respect to the processed surface, please contact us!

Note: The smooth surface to which the support should be attached must be thoroughly cleaned e.g. with isopropyl alcohol!
Optimal processing temperature +15 to +25°C. For additional important information please refer to the installation instructions.
Additional types on request.

Roof bushing



60

Ord. no. 111 598

Roof bushing for flat roofs, e.g. for internal down-conductors.

Specification	Fit	PU	Ord. no.
Nylon with PVC-sealing grommet (150 x 150 mm)	ø 8/10/16 mm	1	111 598

*) **Type A (fl)** = fixed conductor leading; **Type B (ll)** = loose conductor leading



PR-ÖKO 3 Roof conductor holder

Benefits PR-ÖKO 3:

- High quality: Stainless steel clip with loose conductor leading.
- Specification: Compressed concrete block (weight: 1.2 kg) - 100% recyclable.
- No frost-sensitive cavities and recesses - totally frost-resistant.
- Weather-resistant plastic base plate made of HD-PE material.
- Application also without plastic base plate possible (e.g. on gravel roofs).



Roof conductor holder for flat roofs with stainless steel conductor holders ø 8 mm.

Specification	Fit	PU	Ord. no.
with plastic base plate	ø 8 mm	8	111 730
without plastic base plate for gravel roofs	ø 8 mm	8	111 731

PR-ÖKO 3 (J.P. patent) Roof conductor holder

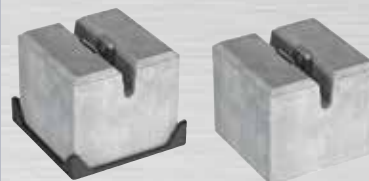

Ord. no. 111 730

Ord. no. 111 731

PR-ÖKO 2

Benefits PR-ÖKO 2:

- Weather-resistant plastic component made of HD-PE material, can be installed at cold temperatures of up to -10°C.
- Specification: Compressed concrete block (weight: 1 kg) - 100% recyclable.
- No frost-sensitive cavities and recesses - totally frost-resistant.

Roof conductor holder for flat roofs with conductor holder ø 8 mm or ø 10 mm.

Specification	Fit	PU	Ord. no.
Plastic part with concrete stone	ø 8 mm	10	111 630
NEW Plastic part with concrete stone	ø 10 mm	10	111 633

Specification	Fit	PU	Ord. no.
NEW Plastic part for strip fastening	ø 8 mm	10	111 660
NEW Plastic part for strip fastening	ø 10 mm	10	111 663

PR-ÖKO 2 (J.P. patent) Roof conductor holder

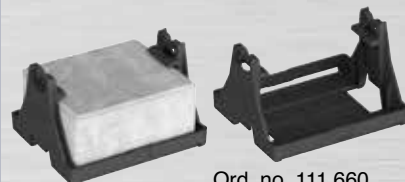

Ord. no. 111 630

Ord. no. 111 660

PR-ÖKO 1

Roof conductor holder for flat roofs; made of black, weather-resistant plastic and recyclable filling with double conductor holder.

Specification	Fit	PU	Ord. no.
With closed plastic casing (weight: 1 kg)	ø 8 mm	10	111 600

PR-ÖKO 1 Roof conductor holder



Ord. no. 111 600

Clamping bracket & fixing clip, to prevent flat roof holders (e.g. Ord. no. 111 630) from slipping on pitched synthetic roofing membranes.

Specification	Fit	PU	Ord. no.
Clamping bracket made of stainless steel V2A with M6 cylinder head screw V2A	ø 8-10 mm	100	910 097
Fixing clip made of stainless steel V2A	ø 8 mm	200	1163

Clamping bracket & fixing clip



Ord. no. 910 097

Ord. no. 1163



Spacer for eaves



Ord. no. 111 480

Spacer for eaves in cranked type on request.

Covering and clamping cap



Ord. no. 111 485

Roof conductor holder and mounting plate



Ord. no. 111 486

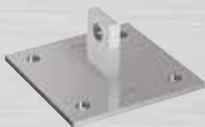

Ord. no. 111 487



Ord. no. 111 488

Roof conductor holder for thatched roofs

Spacer for eaves

Specification	Height (adjustable)	PU	Ord. no.
Spacer for eaves complete			
Steel, hot galvanized	1050-1165 mm	1	111 480
	1400-1510 mm	1	111 481
Stainless steel V2A	1050-1165 mm	1	111 482
	1400-1510 mm	1	111 483

Spacer for eaves in cranked type on request.

Covering and clamping cap suitable for wooden stakes 90 x 90 mm.

Specification	PU	Ord. no.
Steel, hot galvanized	1	111 484
Stainless steel V2A	1	111 485

Roof conductor holder and mounting plate

Specification	PU	Ord. no.
Roof conductor holder made of oak wood	1	111 486
Mounting plate 100 x 100 mm made of stainless steel V2A	1	111 487
Mounting plate 120 x 30 mm made of stainless steel V2A	1	111 488



PRÖ COLOR

Colour design in lightning protection





PRÖ COLOR

The benefits are obvious:

- Components made of hot galvanized steel and **PRÖ COLOR** coating.
- Decorative look and long-lasting.
- Higher quality than hot galvanized components.
- Cheaper than stainless steel V2A.
- Totally maintenance-free.

Roof conductor holder with Niro-Clip



Ord. no. 111 144 az Ord. no. 111 144 ro

Roof conductor holder with Niro-Clip



Ord. no. 111 019 az



Ord. no. 111 019 ro

Roof conductor holder with Niro-Clip

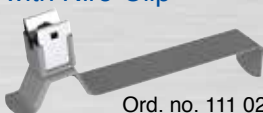

Ord. no. 111 023 az



Ord. no. 111 023 ro

Roof conductor holder w. clamping bracket & Niro-Clip



Ord. no. 111 033 az

Roof conductor holder w. clamping bracket & Niro-Clip



Ord. no. 111 010 az

Ord. no. 111 525 ro

Specifications: ● ro - colour of the conductor holder: red brown
● az - colour of the conductor holder: anthracite

Roof conductor holder suitable for ridge tiles of all sizes
- universally adjustable installing round conductors. **Benefits:** one type fits all!

Specification		Height	Fit	PU	Ord. no.
Bottom part	Niro-Clip *)				
Steel, hot galvanized/coated	Stainless steel V2A/ type A	17 mm	ø 8 mm	100	111 144 az
Steel, hot galvanized/coated	Stainless steel V2A/ type B	16 mm	ø 8 mm	100	111 136 az
Steel, hot galvanized/coated	Stainless steel V2A/ type A	17 mm	ø 8 mm	100	111 144 ro
Steel, hot galvanized/coated	Stainless steel V2A/ type B	16 mm	ø 8 mm	100	111 136 ro

Roof conductor holder for universal use.

Specification		Length	Fit	PU	Ord. no.
Bottom part	Niro-Clip *)				
Steel, hot galvanized/coated	Stainless steel V2A/ type A	210 mm	ø 8 mm	100	111 019 az
Steel, hot galvanized/coated	Stainless steel V2A/ type B	210 mm	ø 8 mm	100	111 540 az
Steel, hot galvanized/coated	Stainless steel V2A/ type A	280 mm	ø 8 mm	100	111 015 az
Steel, hot galvanized/coated	Stainless steel V2A/ type B	280 mm	ø 8 mm	100	111 541 az
Steel, hot galvanized/coated	Stainless steel V2A/ type A	210 mm	ø 8 mm	100	111 019 ro
Steel, hot galvanized/coated	Stainless steel V2A/ type B	210 mm	ø 8 mm	100	111 540 ro
Steel, hot galvanized/coated	Stainless steel V2A/ type A	280 mm	ø 8 mm	100	111 015 ro
Steel, hot galvanized/coated	Stainless steel V2A/ type B	280 mm	ø 8 mm	100	111 541 ro

Roof conductor holder for pantiled roofs.

Specification		Length	Fit	PU	Ord. no.
Bottom part	Niro-Clip *)				
Steel, hot galvanized/coated	Stainless steel V2A/ type A	120 mm	ø 8 mm	150	111 023 az
Steel, hot galvanized/coated	Stainless steel V2A/ type B	120 mm	ø 8 mm	150	111 530 az
Steel, hot galvanized/coated	Stainless steel V2A/ type A	120 mm	ø 8 mm	150	111 023 ro
Steel, hot galvanized/coated	Stainless steel V2A/ type B	120 mm	ø 8 mm	150	111 530 ro

Roof conductor holder with clamping bracket
(clamping range max 5 mm) for slate roofs; especially well suited for later installation!

Specification		Length	Fit	PU	Ord. no.
Bottom part	Niro-Clip *)				
Steel, hot galvanized/ with teeth	Stainless steel/ type A	180 mm	ø 8 mm	200	111 033 az
Steel, hot galvanized/ with teeth	Stainless steel/ type B	180 mm	ø 8 mm	200	111 511 az

Roof conductor holder with clamping bracket
for bitumen shingles and slate roofs or for tiles with large clamping range.

Specification		Clamping range	Fit	PU	Ord. no.
Bottom part	Niro-Clip *)				
Steel, hot galvanized/coated	Stainless st. V2A/ type A	up to 5 mm	ø 8 mm	100	111 010 az
Steel, hot galvanized/coated	Stainless st. V2A/ type B	up to 5 mm	ø 8 mm	100	111 011 az
Steel, hot galvanized/coated	Stainless st. V2A/ type A	up to 18 mm	ø 8 mm	100	111 525 ro
Steel, hot galvanized/coated	Stainless st. V2A/ type A	up to 18 mm	ø 8 mm	100	111 525 az
Steel, hot galvanized/coated	Stainless st. V2A/ type B	up to 18 mm	ø 8 mm	100	111 527 ro
Steel, hot galvanized/coated	Stainless st. V2A/ type B	up to 18 mm	ø 8 mm	100	111 527 az

*) **Type A (fl)** = fixed conductor leading; **Type B (ll)** = loose conductor leading



COLOUR DESIGN in lightning protection

Innovation in colour!

This wish is fulfilled by our COLOUR DESIGN in lightning protection, whose powder-coated components are coloured to match the roof, gutters and rainwater downpipes.

The appearance of an on-roof lightning protection system can be improved by making it unobtrusive to blend in.

Components made of stainless steel, aluminium, hot galvanized steel and also aluminium wires are powder-coated using the sintering technique.

A selection of colours (Additional RAL-colours available!)



The illustrated colour examples may differ from the RAL-colour.

Colour design in lightning protection

Product description

Components:

All lightning protection components are pre-treated and powder-coated in the RAL-colour of your choice.

Powder coating:

The coating powder consists basically of polyester resins, as well as the appropriate weather-, light- and heat-resistant pigments.

The electrostatic charge makes the powder adhere to the component, the ensuing burn-in process binds the powder to the metal permanently. The thickness of the coating is about 60 to 90 μm . To ensure optimal conductivity, the clamping area (e.g. inner surface of the Multi-clamp) remains uncoated.

Wire:

Aluminium wire soft, \varnothing 8 mm (Ord. no. 100 019 S) per ring à 10 kg, powder coated.

Important! The following installation instructions must be adhered to:

When installing the wire, the coating must be removed in the area of the clamping connection without changing the cross section to guarantee a faultless conductive and lightning-current proof connection.

The coating in the clamping area of the aluminium wire is scraped off with a "skinning tool".

Prices for "colour design in lightning protection" on request.



Special components

Our long experience in the construction, development and manufacturing of lightning protection components, surge protection devices and earthing material has shown us that some lightning protection systems cannot be perfected using only the parts offered on the market.

For that reason, our company manufactures **special components according to your wishes and ideas** as

- punched parts
- turned parts
- cast parts
- welded constructions and
- special tools

according to drawings or samples out of

- stainless steel V2A and V4A
- copper
- steel or
- aluminium

in both small and large series.

Special air termination rods & special holders in stainless steel and GRP



Special mounting system in stainless steel for air termination rods



Rope spans





Connection clamps, terminal clamps, bridgings, pipe clamps

Connection and
terminal clamps





Multi-Quattro **NEW!**



Ord. no. 111 307

Multi-Quattro **NEW!**



Ord. no. 111 317

Multi-Plus terminal clamp (J.P. patent)



Ord. no. 111 270

Connecting- and terminal clamp

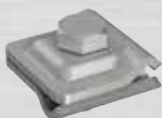

Ord. no. 111 313



Ord. no. 111 319

Multi-Quattro **NEW!**

Benefits:

- Just one clamp for all wire connections.
- Shortened and simplified installation – just one screw M10.
- For connection of 2 - 4 wires \varnothing 8 mm

Multi-Quattro clamping jaw for connection of 2 - 4 wires \varnothing 8 mm

Specification	Fit	PU	Ord. no.
Steel, hot galvanized	\varnothing 8 mm	100	111 304
Aluminium	\varnothing 8 mm	100	111 305
Copper	\varnothing 8 mm	100	111 306
Stainless steel V2A	\varnothing 8 mm	100	111 307



Multi-Quattro terminal and connecting clamp for connection of 2 - 4 wires \varnothing 8 mm

Specification	Fit	PU	Ord. no.
Steel, hot galvanized	\varnothing 8 mm	100	111 314
Aluminium	\varnothing 8 mm	100	111 315
Stainless steel V2A	\varnothing 8 mm	100	111 317



System Multi-clamp

Multi-Plus metal sheet terminal and connection clamp. Same connection configurations as the original Multi-clamp with guaranteed 10 cm² contact surface, clamping range up to 8 mm.

Specification	Carriage bolt with nut	Fit	PU	Ord. no.
Steel, hot galvanized	Steel, hot galvanized	\varnothing 8-10 mm	50	111 270
Steel, hot galvanized	Stainless steel V2A	\varnothing 8-10 mm	50	111 270 S
Aluminium 4 mm	Steel, hot galvanized	\varnothing 8 mm	50	111 271
Aluminium 4 mm	Stainless steel V2A	\varnothing 8 mm	50	111 271 S
Copper	Coppered	\varnothing 8 mm	50	111 272
Stainless steel V2A	Stainless steel V2A	\varnothing 8-10 mm	50	111 273
Bimetal aluminium/copper	Stainless steel V2A	\varnothing 8 mm	50	111 274

All specifications also available with \varnothing 4-6 mm clamping range

Connecting and terminal clamp

completely made of stainless steel V4A, for wire mesh mats for potential control.

Specification	Fit	PU	Ord. no.
Connection clamp: Multi-Mini	\varnothing 4-6 / \varnothing 4-6 mm	1	111 313
Terminal Clamp: Multi-Mini	\varnothing 10 / \varnothing 4-6 mm	1	111 319

Original Multi-clamp

The **original Multi-clamp** was invented by J. Pröpster in 1981 and since then has been established a million times worldwide. It is the most varied lightning protection component and the centerpiece of the multifunctional system of J. Pröpster.

The universal use of the Multi-Clamp as T-, cross, parallel, thrust and connection clamp is unmatched.

- Benefits:**
- Only one clamp for all wire connections.
 - Maximum contact due to consistent clamping.
 - Extremely shortened installation time - only one screw M10.
 - Optimal handling at planning, acquisition and storage.

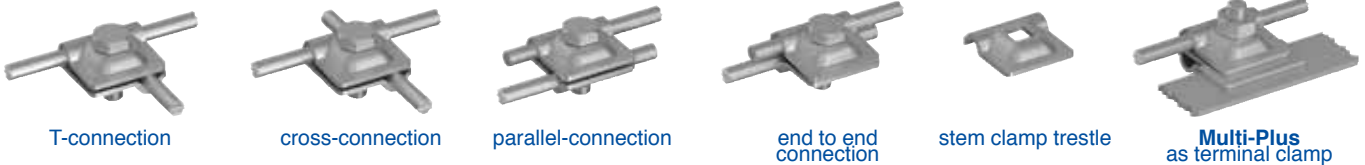

Multi-clamp, for the universal use as T-, cross-, parallel- and end to end-connection.

Specification	Carriage bolt with nut	Fit	PU	Ord. no.
Steel, hot galvanized	Steel, hot galvanized	ø 8-10 mm	100	1270
Aluminium 4 mm	Steel, hot galvanized	ø 8 mm	100	1271
Steel, hot galvanized 4 mm	Steel, hot galvanized	ø 8-10 mm	100	1277
Steel, hot galvanized for reinforcements	Steel, hot galvanized	ø 4-6 mm	100	111 279
Steel, bare	Steel, hot galvanized	ø 8-10 mm	100	911 224
Copper	Stainless steel V2A	ø 8 mm	100	910 101
Stainless steel V2A	Stainless steel V2A	ø 8-10 mm	100	910 107

Specification	Hexagonal screw	Fit	PU	Ord. no.
Copper	Coppered	ø 8 mm	100	1272
Stainless steel V2A	Stainless steel V2A	ø 8-10 mm	100	1273
Bimetal aluminium/copper	Stainless steel V2A	ø 8 mm	100	1274
Steel, hot galvanized	Stainless steel V2A	ø 8-10 mm	100	1275
Aluminium 4 mm	Stainless steel V2A	ø 8 mm	100	1276

Multi-clamp ø 10 mm, heavy-duty type for the universal use as T-, cross-, parallel- and end to end-connection.

Specification	Carriage bolt with nut	Fit	PU	Ord. no.
Steel, hot galvanized	Steel, hot galvanized	ø 10 mm	75	1278
Stainless steel V2A	Stainless steel V2A	ø 10 mm	75	1279
Stainless steel V4A	Stainless steel V2A	ø 10 mm	75	1279 S
Copper	Coppered	ø 10 mm	75	111 280

Multi-clamp ø 8-10 mm / ø 16 mm

Benefits: The reliable Multi-clamp system for ø 16 mm rod connections.

Specification	Carriage bolt with nut	Fit	PU	Ord. no.
Steel, hot galvanized	Steel, hot galvanized	ø 8-10 / ø 16 mm	50	111 430
Copper	Coppered	ø 8 / ø 16 mm	50	111 432
Stainless steel V2A	Stainless steel V2A	ø 8-10 / ø 16 mm	50	111 433

Original Multi-clamp by J. Pröpster

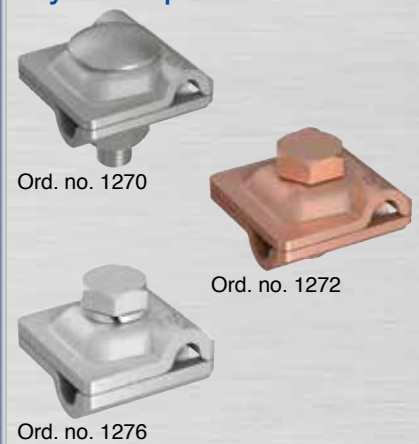

Multi-clamp ø 10 mm



Multi-clamp ø 8-10 mm / ø 16 mm





J.Pröpster CC-Clamping system for connections \varnothing 8-10 / \varnothing 16 mm to clamps, pipe clamps or steel constructions.

- **Type A:** Connection of air termination rods or earth lead-in rods \varnothing 16 mm to clamps, pipe clamps or metal constructions.
- **Type B:** Connection of rods \varnothing 16 mm and conductors \varnothing 8-10 mm to clamps, pipe clamps or metal constructions.
- **Type C:** Connection and disconnection clamp \varnothing 8-10 / \varnothing 16 mm - also suitable for cable connections.

Benefits:

- Clamping system for round connectors \varnothing 8-10 / \varnothing 16 mm.
- Variable fixing lengths by easy swap of the hexagonal bolt M10.

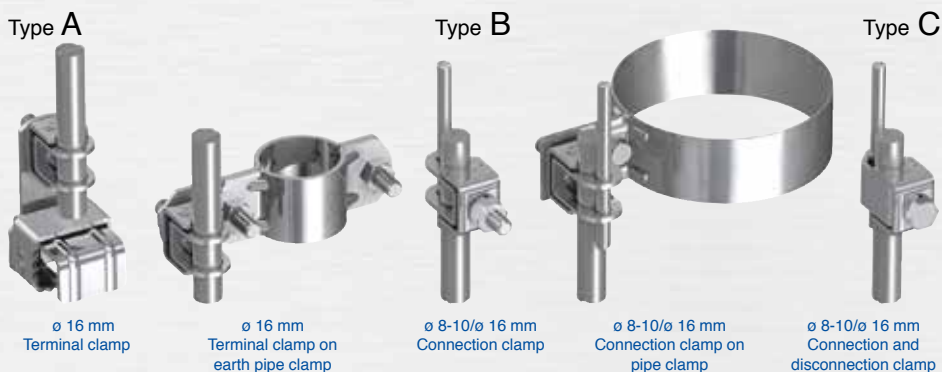

J.Pröpster CC-Clamp

Type A



Ord. no. 1460

Type B



Ord. no. 1461

U-Connector



Ord. no. 111 410

J.Pröpster CC-Clamp

for the connection of round connectors \varnothing 8-10 mm and air termination rods \varnothing 16 mm.

Specification	Type	Fit	PU	Ord. no.
Steel, hot galvanized	A	\varnothing 16 mm	50	1455
Stainless steel V2A	A	\varnothing 16 mm	50	1460
Steel, hot galvanized	B	\varnothing 8-10 / \varnothing 16 mm	50	1456
Stainless steel V2A	B	\varnothing 8-10 / \varnothing 16 mm	50	1461

CC-Disconnection Clamp (Type C) on page 75

U-Connector with hexagonal screw M10 V2A for round connector \varnothing 8-10 mm and air termination rods \varnothing 16 mm.

Specification	Fit	PU	Ord. no.
Steel, hot galvanized	\varnothing 8-10 / \varnothing 16 mm	100	111 410
Copper	\varnothing 8-10 / \varnothing 16 mm	100	111 411
Stainless steel V2A	\varnothing 8-10 / \varnothing 16 mm	100	111 412



Connectors

Clamping jaw, suitable for one or two round conductors with □ 11 mm square hole, light-weight type with ø 8.5 mm.

Specification	Bore hole	Fit	PU	Ord. no.
Steel, hot galvanized	□ 11 mm	ø 8-10 mm	100	1284
Aluminium		ø 8 mm	100	1285
Copper		ø 8 mm	100	1286
Stainless steel V2A		ø 8-10 mm	100	1287
Steel, hot galvanized	light-weight type ø 8.5 mm	ø 6-8 mm	100	111 284
Aluminium		ø 6-8 mm	100	111 285
Copper		ø 6-8 mm	100	111 286
Stainless steel V2A		ø 6-8 mm	100	111 287

Clamping jaw



Ord. no. 1284

Ord. no. 111 284

Dual-cross terminal and connection clamps

Specification	Fit	PU	Ord. no.
Suitable for one or two round conductors with M10 screw and nut, with base plate.			
Steel, hot galvanized	ø 8-10 mm	100	1280
Aluminium	ø 8 mm	100	1281
Copper	ø 8 mm	100	1282
Stainless steel V2A	ø 8-10 mm	100	1283
Suitable for three or four round conductors with M10 screw and nut, with intermediate plate.			
Steel, hot galvanized	ø 8-10 / ø 8-10 mm	100	1480
Aluminium	ø 8 / ø 8 mm	100	1481
Stainless steel V2A	ø 8-10 / ø 8-10 mm	100	1483

Dual-cross terminal and connection clamp



Ord. no. 1280

Ord. no. 1483

KS-Connector

Clamping screw with hexagonal nut M10 suitable for round conductor ø 6-10 mm.

Specification	Fit	PU	Ord. no.
Steel, hot galvanized / aluminium clamping ring	ø 6-10 mm	100	1360
Steel, hot galvanized with square clamping bracket	ø 8-10 mm	100	1359
Stainless steel V2A coppered	ø 6-10 mm	100	1361
Stainless steel V2A	ø 6-10 mm	100	1362
Stainless steel V4A	ø 8-10 mm	100	1462

KS-Connector



Ord. no. 1362

Ord. no. 1462

KS-Connector, double

Clamping screw with hexagonal nut M10 suitable for round conductor ø 6-10 mm.

Specification	Fit	PU	Ord. no.
Steel, hot galvanized / aluminium clamping ring	ø 6-10 mm	50	111 370
Stainless steel V2A coppered	ø 6-10 mm	50	111 371
Stainless steel V2A	ø 6-10 mm	50	2000

KS-Connector, double



Ord. no. 2000



ES-connector



Ord. no. 2105

Connection Clamp



Ord. no. 2100

Terminal angle



Ord. no. 1363

Ord. no. 1381

Terminal angle



Ord. no. 1383

Ord. no. 1384

Terminal angle with terminal clamp

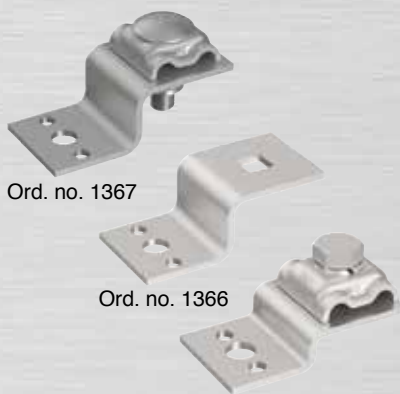

Ord. no. 1367

Ord. no. 1366

Ord. no. 910 183

ES-connector with screw and nut M10 for the connection of round conductors.

Specification	Fit	PU	Ord. no.
Zinc die-cast with hot galvanized steel-screw	ø 8 mm	100	2105
Zinc die-cast with V2A-screw and nut	ø 8 mm	100	2106

Connection clamp for the connection of two round conductors.

Specification	Fit	PU	Ord. no.
Zinc die-cast	ø 8-10 mm	100	2100
Aluminium	ø 8 mm	100	2101
Aluminium continuous casting	ø 8-10 mm	100	2104
Copper	ø 8 mm	100	2102
Stainless steel V2A	ø 8 mm	100	2103
Stainless steel V2A	ø 10 mm	100	2107
Aluminium, mounted with four M8 hexagonal screws stainless steel V2A	ø 16 mm	25	2108

Terminal angle for the connection to metal constructions. With or without clamping jaw.

Specification	Fit	PU	Ord. no.
Aluminium with connector	ø 8 mm	50	1363
Aluminium without connector	---	100	1381
Copper with connector	ø 8 mm	50	1364
Copper without connector	---	100	1382
Stainless steel V2A with connector	ø 8-10 mm	50	1390 S
Stainless steel V2A without connector	---	100	1390

Terminal angle to screw or weld on metal constructions. Bore hole: 2x ø 11 mm; 1x □ 11 mm

Specification	Fit	PU	Ord. no.
Steel, hot galvanized with KS-Connector	ø 6-10 mm	50	1383
Steel, hot galvanized without KS-Connector	---	100	1384
Stainless steel V2A without KS-Connector	---	100	1385

Terminal angle for the connection of metal structural cladding. With or without clamping jaw.

Specification	Fit	PU	Ord. no.
Aluminium with connector, screw and nut	ø 8 mm	50	1367
Copper with connector, screw and nut	ø 8 mm	50	1368
Aluminium without connector	---	50	1366

Also available with KS-Connector

Specification	Fit	PU	Ord. no.
Aluminium with connector, hexagonal screw and thread	ø 8 mm	50	910 183

Gutter clamps

- Benefits:**
- Perfect, large clamping area below the bead.
 - Slim conductor holder design - only 32 mm wide, safety tested.
 - Clamping screws always made of stainless steel V2A.
 - Installation: Clamp and down conductor wire can be mounted separately.

Gutter clamp - ideal,

for secure connection on gutters with up to \varnothing 20 mm bead thicknesses.

Specification	Fit	PU	Ord. no.
Steel, hot galvanized/zinc-plated	\varnothing 6-8 mm	25	111 670
Aluminium, Wire clamp stainless steel V2A	\varnothing 6-8 mm	25	111 671
Copper	\varnothing 6-8 mm	25	111 672
Stainless steel V2A	\varnothing 6-8 mm	25	111 673
Bimetal Wire clamp - stainless steel V2A Bead clamp - copper	\varnothing 6-8 mm	25	111 674

Gutter terminal clamp to fix air termination conductors and down conductors to the gutter. Fits for bead thicknesses \varnothing 15 - 20 mm.

Specification	Fit	PU	Ord. no.
Steel, hot galvanized	\varnothing 8-10 mm	25	1306
Aluminium	\varnothing 8 mm	25	1305
Copper	\varnothing 8 mm	25	1307
Stainless steel V2A	\varnothing 8-10 mm	25	1308
Aluminium with Stainless steel V2A - screw	\varnothing 8 mm	25	1305 S
Bimetal Wire clamp - aluminium Bead clamp - copper	\varnothing 8 mm	25	1307 Z

Additional versions on request

Gutter clamp - slim to fix air termination conductors and down conductors to the gutter. Fits for bead thicknesses with up to \varnothing 20 mm.

Specification	Fit	PU	Ord. no.
Steel, hot galvanized	\varnothing 6-8 mm	50	111 675
Aluminium, Wire clamp stainless steel V2A	\varnothing 6-8 mm	50	111 676
Copper	\varnothing 6-8 mm	50	111 677
Stainless steel V2A	\varnothing 6-8 mm	50	111 678
Bimetal Wire clamp - stainless steel V2A Bead clamp - copper	\varnothing 6-8 mm	50	111 679

Gutter clamp fits for bead thicknesses \varnothing 10 - 20 mm.

Specification	Fit	PU	Ord. no.
Steel, hot galvanized	\varnothing 8-10 mm	50	1302
Aluminium	\varnothing 8 mm	50	1301
Copper	\varnothing 8-10 mm	50	1300
Stainless steel V2A	\varnothing 8 mm	50	2001
Bimetal Wire clamp - aluminium Bead clamp - copper	\varnothing 8 mm	50	1300 Z

Specification with hexagonal screw available

Conductor collar for down conductors to protect frontages and walls from running rainwater

Specification	Fit	PU	Ord. no.
Plastic grey for conductors	\varnothing 8 mm	100	1042 S
Plastic copper - coloured for conductors	\varnothing 8 mm	100	1046 S

More information about the bimetal system on pages 82 and 83.

Gutter clamp - ideal



Ord. no. 111 670

Gutter terminal clamp (J&P patent)



Ord. no. 1306

Gutter clamp - slim



Ord. no. 111 675

Gutter clamp



Ord. no. 1302

Conductor collar



Ord. no. 1042 S



Disconnecting clamp



Ord. no. 1330



Ord. no. 1332



Ord. no. 111 405

Disconnecting clamp



Ord. no. 1333

Disconnecting clamp



Ord. no. 111 375

Disconnection clamp

Disconnecting clamp according to EN 62561-1 fits for round conductors \varnothing 8-10 / \varnothing 16 mm or \varnothing 8 / \varnothing 10 mm, mounted with two hexagonal screws M8 stainless steel V2A.

Specification	Fit	PU	Ord. no.
Aluminium	\varnothing 8-10 / \varnothing 16 mm	50	1330

Specification	Fit	PU	Ord. no.
Aluminium	\varnothing 8-10 / \varnothing 10 mm	50	1332

Specification	Fit	PU	Ord. no.
Copper-alloy	\varnothing 8-10 / \varnothing 16 mm	50	1331
Zinc die-cast, closed type	\varnothing 8-10 / \varnothing 16 mm	50	111 405

See also Vario-Disconnecting clamp on pages 76 and 77.

Disconnecting clamp fits for round connectors \varnothing 8 mm to \varnothing 10 mm, with one screw M10 and nut.

Specification	Fit	PU	Ord. no.
Stainless steel V2A	\varnothing 8 / \varnothing 10 mm	50	1333

Disconnecting clamp according to EN 62561-1, with two KS-Connectors steel, hot galvanized M10 and two hexagonal screws M8 stainless steel V2A.

Specification	Fit	PU	Ord. no.
Steel, hot galvanized / aluminium	\varnothing 6-10 / \varnothing 6-10 mm	50	111 375

Clamp in copper or bimetal on request.



Disconnecting clamp with connecting bracket

Benefits:

- Improved flush fit with open-end wrench by patented cylindrical design of the Vario-clamp upper part.
- Universal utilization, e.g. installation with a terminal clamp on a T-beam or direct installation on a fixed earthing terminal.
- Economical solution: Connecting bracket and disconnection within one component.

Disconnecting clamp with terminal angle,

for test joints \varnothing 8-10 mm or flat 30 mm; mounted with 2 hexagonal screws M8.

Specification	Bore	Conductor height	Fit	PU	Ord. no.
Steel, hot galvanized	\varnothing 12.5 mm	14 mm	\varnothing 8-10 mm	50	111 700
Stainless steel V2A	\varnothing 12.5 mm	14 mm	\varnothing 8-10 mm	50	111 701
Stainless steel V4A	\varnothing 12.5 mm	14 mm	\varnothing 8-10 mm	50	111 704
Steel, hot galvanized	\varnothing 12.5 mm	14 mm	fl. 30 mm	50	111 702
Stainless steel V2A	\varnothing 12.5 mm	14 mm	fl. 30 mm	50	111 703
Stainless steel V4A	\varnothing 12.5 mm	14 mm	fl. 30 mm	50	111 705

Connection bracket with rivet design upon request.

Disconnecting clamp with terminal angle -high version-,

for test joints \varnothing 8-10 mm or flat 30 mm; mounted with 2 hexagonal screws M8.

Suitable for measurements with clamp-on ground resistance tester (Ord. no. 2081 or 2084).

Specification	Bore	Conductor height	Fit	PU	Ord. no.
Steel, hot galvanized	\varnothing 12.5 mm	30 mm	\varnothing 8-10 mm	50	111 740
Stainless steel V2A	\varnothing 12.5 mm	30 mm	\varnothing 8-10 mm	50	111 741
Stainless steel V4A	\varnothing 12.5 mm	30 mm	\varnothing 8-10 mm	50	111 744
Steel, hot galvanized	\varnothing 12.5 mm	30 mm	fl. 30 mm	50	111 742
Stainless steel V2A	\varnothing 12.5 mm	30 mm	fl. 30 mm	50	111 743
Stainless steel V4A	\varnothing 12.5 mm	30 mm	fl. 30 mm	50	111 745

Connection bracket with rivet design on request.

Application examples



with terminal clamp, heavy-duty type



with fixed earthing terminal

J.Pröpster CC-Clamping system

for the connection of round conductors \varnothing 8-10 mm and air termination rods \varnothing 16 mm.

Specification	Type	Fit	PU	Ord. no.
Steel, hot galvanized	C	\varnothing 8-10/ \varnothing 16 mm	50	1457
Stainless steel V2A	C	\varnothing 8-10/ \varnothing 16 mm	50	1458
Copper	C	\varnothing 8-10/ \varnothing 16 mm	50	1459

Also suitable for cable connection. Additional CC-Clamps on page 70.

Disconnecting clamp with terminal angle

NEW!



Ord. no. 111 700

Ord. no. 111 702



Ord. no. 111 740

Ord. no. 111 742

J.Pröpster CC-Disconnecting Clamp

Type C



Ord. no. 1458



System Vario-clamp with M10 screws, made of material 40x4 mm

The **original system Vario-clamp** is a practical solution for connecting differently shaped conductors. All parts are manufactured using punching technology and are interchangeable.



ø 8-10/8-10 mm



ø 8-10/16 mm



ø 8-10/30x3.5 mm
ø 8-10/40x4 mm



30x3.5/30x3.5 mm
40x4/40x4 mm

Vario-Disconnecting clamp



Ord. no. 1340



Ord. no. 111 339

Vario-Disconnecting clamp, for test joints round/flat, flat/flat and round/round; mounted with two hexagonal screws M10 stainless steel V2A.

Specification		Fit	PU	Ord. no.
Steel, hot galvanized	two-part	round/flat	ø 8-10/30 mm	50 1340
Steel, hot galvanized	two-part	round/flat	ø 8-10/40 mm	50 1346
Steel, hot galvanized	two-part	flat/flat	30/30 mm	50 1343
Steel, hot galvanized	two-part	flat/flat	40/40 mm	50 2044
Steel, hot galvanized	two-part	round/round	ø 8-10/ø 8-10 mm	50 1339
Stainless steel V2A	two-part	round/flat	ø 8-10/30 mm	50 2012
Stainless steel V2A	two-part	flat/flat	30/30 mm	50 2014
Stainless steel V2A	two-part	round/round	ø 8-10/ø 8-10 mm	50 2016
Copper	two-part	round/round	ø 8-10/ø 8-10 mm	50 1337
Steel, hot galvanized	three-part	round/round	ø 8-10/ø 8-10 mm	50 111 339
Copper	three-part	round/round	ø 8-10/ø 8-10 mm	50 111 337
Copper-Steel, hot gal.	three-part	round/flat	ø 8-10/30 mm	50 1342 Z
Stainless steel V2A	three-part	round/round	ø 8-10/ø 8-10 mm	50 910 579

Vario-Disconnecting clamp



Ord. no. 1341



Ord. no. 1345

Vario-Disconnecting clamp, for test joints round/round; mounted with two hexagonal screws M10 stainless steel V2A.

Specification		Fit	PU	Ord. no.
Steel, hot galvanized	two-part	round/round	ø 8-10/ø 16 mm	50 1341
Aluminium	two-part	round/round	ø 8-10/ø 16 mm	50 1344
Copper	two-part	round/round	ø 8-10/ø 16 mm	50 111 341
Stainless steel V2A	two-part	round/round	ø 8-10/ø 16 mm	50 2006
Copper-Steel, hot gal.	three-part	round/round	ø 8-10/ø 16 mm	50 1348 Z
Steel, hot galvanized	three-part	round/round	ø 8-10/ø 16 mm	50 1345
Aluminium	three-part	round/round	ø 8-10/ø 16 mm	50 111 344
Copper	three-part	round/round	ø 8-10/ø 16 mm	50 111 345
Stainless steel V2A	three-part	round/round	ø 8-10/ø 16 mm	50 2007
Steel, hot gal. - Copper	three-part	round/round	ø 8-10/fl.30/ø 16 mm	50 1349 Z
Copper-Steel, hot gal.	three-part	round/round	ø 8-10/ø 8-10 mm	50 1343 Z

Vario-Connecting clamp, two-part



Ord. no. 1342

Vario-Connecting clamp, for flat/round and flat/flat connections; mounted with two screws M10 steel, hot galvanized.

Specification		Fit	PU	Ord. no.
Steel, hot galvanized	two-part	round/flat	ø 8-10/30 mm	50 1342
Steel, hot galvanized	two-part	round/flat	ø 8-10/40 mm	50 2043
Steel, hot galvanized	two-part	flat/flat	30/30 mm	50 1347

More information about the bimetal Vario-clamp can be found on pages 82 and 83.

System Vario-clamp M8-Plus with screws M8, made of material 30x3 mm

The original system Vario-clamp M8-Plus, is a reasonably priced, practical solution for connecting differently shaped conductors. All parts are manufactured using punching technology and are interchangeable.

Benefits: The patented cylindrical attachment on the upper part significantly improves installation..



ø 8-10/8-10 mm



ø 8-10/16 mm



ø 8-10/30x3.5 mm



30x3.5/30x3.5 mm



System Bimetal
ø 8-10/30x3.5 mm

Vario-Disconnecting clamp M8-Plus,

for test joints round/flat, flat/flat und round/round; mounted with two hexagonal screws M8 V2A.

Specification			Fit	PU	Ord. no.
Steel, hot galvanized	two-part	round/flat	ø 8-10 / 30 mm	50	111 716
Steel, hot galvanized	two-part	flach/flach	30 / 30 mm	50	111 718
Steel, hot galvanized	two-part	round/round	ø 8-10 / ø 8-10 mm	50	111 710
Stainless steel V2A	two-part	round/flach	ø 8-10 / 30 mm	50	111 717
Stainless steel V2A	two-part	flach/flach	30 / 30 mm	50	111 719
Stainless steel V2A	two-part	round/round	ø 8-10 / ø 8-10 mm	50	111 711
Copper	two-part	round/round	ø 8-10 / ø 8-10 mm	50	111 712
Steel, hot galvanized	three-part	round/round	ø 8-10 / ø 8-10 mm	50	111 713
Copper	three-part	round/round	ø 8-10 / ø 8-10 mm	50	111 715
Copper-steel, hot gal.	three-part	round/flach	ø 8-10 / 30 mm	50	111 727
Stainless steel V2A	three-part	round/round	ø 8-10 / ø 8-10 mm	50	111 714

Sure torque transmission thanks to a better form fit. (open-ended spanner rests securely on the screw head).

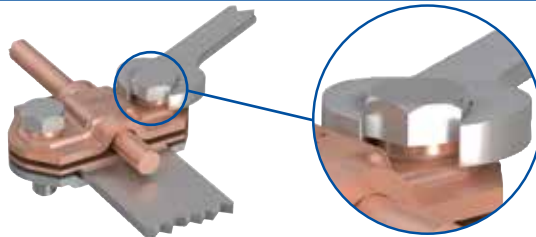

Screw head sits higher due to collar

Vario-Disconnecting clamp M8-Plus (J.P. patent)



Ord. no. 111 717



Ord. no. 111 727



Ord. no. 111 714

Vario-Disconnecting clamp M8-Plus,

for test joints round/round; mounted with two hexagonal screws M8 stainless steel V2A.

Specification			Fit	PU	Ord. no.
Steel, hot galvanized	two-part	round/round	ø 8-10 / ø 16 mm	50	111 720
Copper	two-part	round/round	ø 8-10 / ø 16 mm	50	111 722
Stainless steel V2A	two-part	round/round	ø 8-10 / ø 16 mm	50	111 721
Steel, hot galvanized	three-part	round/round	ø 8-10 / ø 16 mm	50	111 723
Copper	three-part	round/round	ø 8-10 / ø 16 mm	50	111 725
Stainless steel V2A	three-part	round/round	ø 8-10 / ø 16 mm	50	111 724
Copper-Steel, hot gal.	three-part	round/round	ø 8-10 / ø 16 mm	50	111 728
Steel, hot gal.- Copper	three-part	round/round	ø 8-10/fl.30/ø 16 mm	50	111 729
Copper-Steel, hot gal.	three-part	round/round	ø 8-10 / ø 8-10 mm	50	111 726

Test plates used for Vario-Disconnecting clamp and Vario-Disconnecting clamp M8-Plus on page 86.



Vario-Disconnecting clamp M8-Plus (J.P. patent)



Ord. no. 111 721



Ord. no. 111 724



Ord. no. 111 700

Disconnection clamp with terminal angle (Ord. no. 111 700) on page 75.



Multi-Plus terminal clamp (J&P patent)



Ord. no. 111 270

Saddle clamp (J&P utility patent)



Ord. no. 1334

Saddle clamp (J&P utility patent)



Ord. no. 111 680

Saddle clamp



Ord. no. 1292

Cross-saddle clamp



Ord. no. 1297

Ord. no. 1296

Saddle clamps

Multi-Plus metal sheet terminal and connection clamp. Same connection configurations as the original Multi-clamp with guaranteed 10 cm² contact surface, clamping range up to 8 mm.

Specification	Carriage bolt with nut	Fit	PU	Ord. no.
Steel, hot galvanized	Steel, hot galvanized	ø 8-10 mm	50	111 270
Steel, hot galvanized	Stainless steel V2A	ø 8-10 mm	50	111 270 S
Aluminium 4 mm	Steel, hot galvanized	ø 8 mm	50	111 271
Aluminium 4 mm	Stainless steel V2A	ø 8 mm	50	111 271 S
Copper	Coppered	ø 8 mm	50	111 272
Stainless steel V2A	Stainless steel V2A	ø 8-10 mm	50	111 273
Bimetal aluminium/copper	Stainless steel V2A	ø 8 mm	50	111 274

All specifications also available with ø 4-6 mm clamping range

Saddle clamp with guaranteed 10 cm² contact surface for metal sheet connections. **Clamping range up to 5 mm.**

Specification	Fit	PU	Ord. no.
Steel, hot galvanized	ø 8-10 mm	50	1334
Copper	ø 8-10 mm	50	1336
Aluminium/stainless steel V2A	ø 8-10 mm	50	1335

Saddle clamp for secure contact connection to metal sheets and steel constructions. **Clamping range up to 6 mm.**

Specification	Fit	PU	Ord. no.
Steel, hot galvanized	ø 8-10 mm	50	111 680
Copper	ø 8-10 mm	50	111 681
Aluminium/Stainless steel V2A	ø 8 mm	50	111 682
Stainless steel V2A	ø 8-10 mm	50	111 683
Bimetal copper/aluminium	ø 8 mm	50	111 684

Saddle clamp for the connection to saddles, lengthwise and crosswise conductor connection. **Clamping range up to 5 mm.**

Specification	Fit	PU	Ord. no.
Steel, hot galvanized	ø 8-10 mm	50	1292
Copper	ø 8-10 mm	50	1293
Stainless steel V2A	ø 8-10 mm	50	910 105
Aluminium	ø 8-10 mm	50	1263

With screw-in cover on request.

Cross-saddle clamp mounted with four cylinder head screws M6 V2A. Upper part securely riveted, for lengthwise and crosswise conductor connection. **Clamping range up to 8 mm.**

Specification	Fit	PU	Ord. no.
Steel, hot galvanized	ø 8-10 mm	50	1297
Copper	ø 8-10 mm	50	1298
Stainless steel V2A	ø 8-10 mm	50	1299
Aluminium	ø 8-10 mm	50	1264
Zinc die-cast clamping range max. 5 mm	ø 8-10 mm	50	1296



Multi-Mini-saddle clamp - slim specification

NEW!

For connection of conductors with sheets and folds

Benefits:

- For connection of cables with sheets and profiles up to 8 mm.
- For conductors from 6 mm² to 50 mm² (ø 2.8 mm - ø 8 mm).
- Suitable for lengthwise and crosswise conductor installation.
- Also suitable for potential equalization applications.

Multi-Mini-saddle clamp for potential equalization.
Suitable for lengthwise and crosswise installation. Clamping range up to ø 8 mm.

Specification	Fit	PU	Ord. no.
Stainless steel V2A	6 mm ² (ø 2.8 mm) - 50 mm ² (ø 8 mm)	100	111 780
Stainless steel V2A/coppered	6 mm ² (ø 2.8 mm) - 50 mm ² (ø 8 mm)	100	111 781
Steel, hot galvanized	6 mm ² (ø 2.8 mm) - 50 mm ² (ø 8 mm)	100	111 782

Attic - saddle clamp

NEW!

for connection of the down conductor with the attic sheet without damaging the drip edge

Benefits:

- Connection clamp for secure mounting of an attic sheet.
- Simple installation.
- No damaging or flattening of the drip edge.
- Particularly advantageous if the clamp needs to be repositioned.

Attic - saddle clamp
for connection of the down conductor with the attic sheet without damaging the drip edge

Specification	Fit	PU	Ord. no.
Steel, hot galvanized	ø 8-10 mm	50	111 666
Aluminium	ø 8 mm	50	111 667
Stainless steel V2A	ø 8-10 mm	50	111 669

Multi-Plus-saddle clamp

NEW!

Benefits:

- Lengthwise or crosswise conductor leading possible on top of the standing seam.
- 10 cm² contact surface on the standing seam or sheet.

Multi-Plus-saddle clamp with bracket and **double terminal clamp**. For connecting saddles and sheets lengthwise and crosswise conductor leading. Clamping range up to 8 mm

Specification	Fit	PU	Ord. no.
Steel, hot galvanized	ø 8-10 mm	25	111 880
Aluminium	ø 8 mm	25	111 881
Copper	ø 8 mm	25	111 882
Stainless steel V2A	ø 8-10 mm	25	111 883

Additional Benefit:

- For another conductor leading along the standing seam (e.g. down conductor)

Multi-Plus-saddle clamp with bracket and **2 double terminal clamps**. For connecting saddles and sheets lengthwise and crosswise conductor leading. Clamping range up to 8 mm

Specification	Fit	PU	Ord. no.
Steel, hot galvanized	ø 8-10 mm	25	111 870
Aluminium	ø 8 mm	25	111 871
Copper	ø 8 mm	25	111 872
Stainless steel V2A	ø 8-10 mm	25	111 873

Multi-Mini-saddle clamp



Ord. no. 111 780

Application example:



Attic - saddle clamp



Ord. no. 111 666

Application example:



Multi-Plus saddle clamp



Ord. no. 111 882



Ord. no. 111 870



Terminal clamp



Ord. no. 111 685

Terminal clamp



Ord. no. 111 381

Terminal clamp

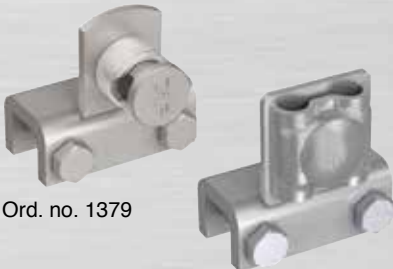

Ord. no. 1379

Ord. no. 1479

Terminal clamp



Ord. no. 111 376

Parallel - saddle clamp



Ord. no. 1295

Terminal clamp

Terminal clamp for the secure contact connection to metal sheets and steel constructions.

Specification	Clamping range	Fit	PU	Ord. no.
Steel, hot galvanized	1 - 5 mm	ø 6-8 mm	50	111 685
Copper	1 - 5 mm	ø 6-8 mm	50	111 686
Aluminium/stainless steel V2A	1 - 5 mm	ø 6-8 mm	50	111 687
Stainless steel V2A	1 - 5 mm	ø 6-8 mm	50	111 688
Bimetal copper /stainless steel V2A	1 - 5 mm	ø 6-8 mm	50	111 689



Terminal clamp for steel constructions. Lengthwise and crosswise connections possible.

Specification	Clamping range	Fit	PU	Ord. no.
Steel, hot galvanized	5 - 18 mm	ø 8-10 mm	25	111 381
Stainless steel V2A	5 - 18 mm	ø 8-10 mm	25	111 382



Terminal clamp for steel constructions. Lengthwise and crosswise connections possible.

Specification	Clamping range	Fit	PU	Ord. no.
Terminal clamp with KS-Connector				
Steel, hot galvanized	5 - 18 mm	ø 6-10 mm	25	1379
Steel, hot galvanized	18 - 35 mm	ø 6-10 mm	25	111 379
Stainless steel V2A	5 - 18 mm	ø 6-10 mm	25	2002
Stainless steel V2A	18 - 35 mm	ø 6-10 mm	25	111 380



Specification	Clamping range	Fit	PU	Ord. no.
Terminal clamp with clamping jaw				
Steel, hot galvanized	5 - 18 mm	ø 8-10 mm	25	1479
Steel, hot galvanized	18 - 35 mm	ø 8-10 mm	25	111 779

Terminal clamp for steel constructions. Lengthwise and crosswise connections possible.

Specification	Clamping range	Fit	PU	Ord. no.
Steel, hot galvanized	bis 12 mm	ø 8-10 mm	50	111 376
Red brass	bis 12 mm	ø 8-10 mm	50	1377

Parallel - saddle clamp, special clamp for snowload-safe installation of the down conductor along the saddle. Clamping range up to 4 mm.

Specification	Fit	PU	Ord. no.
Aluminium	ø 8 mm	50	1295

Terminal clamp, heavy-duty type

- Secure contact connections to steel constructions with up to 52 mm clamping range.
- Variable connections through rotating terminal lugs (360°).
- Connection with KS-Connector, Vario-clamp or with perforated strip possible.

Specification	Clamping range	Fit	PU	Ord. no.
Terminal clamp (heavy-duty type) with terminal lug (bore hole ø 11 mm)				
Steel, hot galvanized	up to 19 mm		25	111 384
Steel, hot galvanized	19 - 36 mm		25	111 385
Steel, hot galvanized	36 - 52 mm		20	111 386
Stainless steel V2A	up to 19 mm		25	111 387
Stainless steel V2A	19 - 36 mm		25	111 388
Stainless steel V2A	36 - 52 mm		20	111 389

Specification	Clamping range	Fit	PU	Ord. no.
Terminal clamp (heavy-duty type) with double terminal clamp				
Steel, hot galvanized	up to 19 mm	ø 8-10 mm	25	111 884
Steel, hot galvanized	19 - 36 mm	ø 8-10 mm	25	111 885
Steel, hot galvanized	36 - 52 mm	ø 8-10 mm	25	111 886
Stainless steel V2A	up to 19 mm	ø 8-10 mm	25	111 887
Stainless steel V2A	19 - 36 mm	ø 8-10 mm	25	111 888
Stainless steel V2A	36 - 52 mm	ø 8-10 mm	25	111 889

Terminal clamp, heavy-duty type, with bracket and double terminal clamp

Specification	Clamping range	Fit	PU	Ord. no.
Steel, hot galvanized	up to 19 mm	ø 8-10 mm	25	111 874
Steel, hot galvanized	19 - 36 mm	ø 8-10 mm	25	111 875
Steel, hot galvanized	36 - 52 mm	ø 8-10 mm	20	111 876
Stainless steel V2A	up to 19 mm	ø 8-10 mm	25	111 877
Stainless steel V2A	19 - 36 mm	ø 8-10 mm	25	111 878
Stainless steel V2A	36 - 52 mm	ø 8-10 mm	20	111 879

Terminal disconnecting clamp, heavy-duty type

Benefits:

- Optimized tight fit with the open-end wrench due to the patented cylindrical part of the Vario-clamp top part.
- For safe contact connection of round conductors or sheets to steel constructions with a material thickness up to 52 mm.
- Economical solution – connecting bracket and disconnecter in one component.

Terminal disconnecting clamp, heavy-duty type

for test joints of ø 8-10 mm or flat 30 mm

Specification	Clamping range	Fit	PU	Ord. no.
Steel, hot galvanized	up to 19 mm	fl. 30 mm	25	111 734
Steel, hot galvanized	19 - 36 mm	fl. 30 mm	25	111 735
Steel, hot galvanized	36 - 52 mm	fl. 30 mm	20	111 736
Stainless steel V2A	up to 19 mm	fl. 30 mm	25	111 737
Stainless steel V2A	19 - 36 mm	fl. 30 mm	25	111 738
Stainless steel V2A	36 - 52 mm	fl. 30 mm	20	111 739
Steel, hot galvanized	up to 19 mm	ø 8-10 mm	25	111 784
Steel, hot galvanized	19 - 36 mm	ø 8-10 mm	25	111 785
Steel, hot galvanized	36 - 52 mm	ø 8-10 mm	20	111 786
Stainless steel V2A	up to 19 mm	ø 8-10 mm	25	111 787
Stainless steel V2A	19 - 36 mm	ø 8-10 mm	25	111 788
Stainless steel V2A	36 - 52 mm	ø 8-10 mm	20	111 789

Terminal clamp, heavy-duty type

(J+P patent)

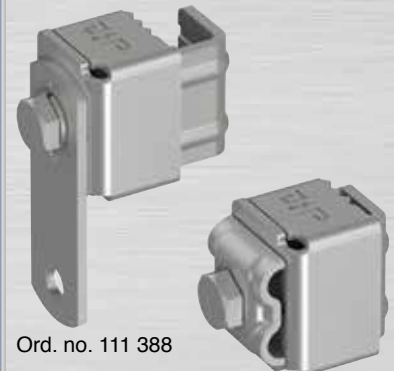

Ord. no. 111 388

Ord. no. 111 887



Ord. no. 111 876

Terminal disconnecting clamp, heavy-duty type

NEW!



Ord. no. 111 737

Ord. no. 111 788



Bimetallic product series (J+P patent)

The "right" connection between different materials. J.Pröpster offers a conform to standards clamping system, which is tested and practice-oriented. It provides a practical and economical way of joining and connecting different materials: copper, hot galvanized steel, aluminium, etc.

- Benefits:**
- Simple handling – no messing about with self-made bimetallic strips.
 - Corrosion-free connections between copper wires and wires made of other materials (e.g. steel, aluminium).
 - Corrosion-free connections between copper wires and components made of other materials
 - earth lead-in rods
 - test joints
 - skylights
 - metal constructions

Bimetal Multi-clamp three-part

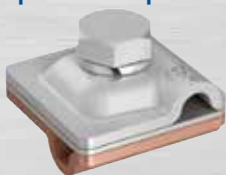

Ord. no. 1274

Bimetal double-terminal clamp



Ord. no. 1288

Bimetal connection Vario-clamp



Ord. no. 1342 Z

Bimetal Vario-clamp M8-Plus



Ord. no. 111 727

Bimetallic bush and bimetallic strip



Ord. no. 1051

Ord. no. 1052



Ord. no. 1053

Bimetal Multi-clamp , three-part, upper piece: aluminium.
intermediate plate: bimetal aluminium/copper. **bottom piece:** copper.

Specification	Fit	PU	Ord. no.
Multi-connection clamp aluminium/copper	ø 8 mm	100	1274
Multi-Plus-connection clamp aluminium/copper with guaranteed 10 cm² contact surface. (picture on page 78)	ø 8 mm	50	111 274

Bimetal double terminal clamp

For the connection between different materials e.g. aluminium and copper.

Specification	Fit	PU	Ord. no.
Upper plate: aluminium + bimetal - plate	ø 8 mm	100	1288
Upper plate: copper + bimetal - plate	ø 8 mm	100	1289

Bimetal Vario-clamp

with screws M10, made of material 40x4 mm.

Specification	Fit	PU	Ord. no.
Round copper on flat Steel, hot galvanized	ø 8-10/ fl. 30 mm	50	1342 Z
Round copper on round (ø 16) Steel, hot galvanized	ø 8-10/ø 16 mm	50	1348 Z
Round copper on round/flat Steel, hot galvanized	ø 16/fl. 30/ø 8-10 mm	50	1349 Z
Round copper on round Steel, hot galvanized	ø 8-10/ø 8-10 mm	50	1343 Z

Bimetal Vario-clamp M8-Plus

with screws M8, made of material 30x3 mm.

Specification	Fit	PU	Ord. no.
Round copper on flat Steel, hot galvanized	ø 8-10/ fl. 30 mm	50	111 727
Round copper on round (ø 16) Steel, hot galvanized	ø 8-10/ø 16 mm	50	111 728
Round copper on round/flat Steel, hot galvanized	ø 16/fl. 30/ø 8-10 mm	50	111 729
Round copper on round Steel, hot galvanized	ø 8-10/ø 8-10 mm	50	111 726

Bimetallic bush and strip

for corrosion resistant connections between steel/aluminium and copper.

Specification	Length	Fit	PU	Ord. no.
Aluminium outside/ copper inside	40 mm	ø 8 mm	100	1051
Aluminium inside/ copper outside	40 mm	ø 8 mm	100	1052
Bimetallic strip, 40 mm wide; 0,5 mm thick	500 mm	---	1	1053



Bimetal gutter clamp for secure contact connections between different materials on gutters. Maximum safety due to perfect clamping; no bead damage.

Specification	Fit	PU	Ord. no.
Wire clamp - stainless steel V2A	ø 6-8 mm	25	111 674
Bead clamp - copper	Bead max. ø 20 mm		

Bimetal gutter clamp for secure contact connections between different materials on gutters. Maximum safety due to perfect clamping; no bead damage.

Specification	Fit	PU	Ord. no.
Wire clamp - stainless steel V2A	ø 6-8 mm	50	111 679
Bead clamp - copper	Bead max. ø 20 mm		

Bimetal gutter connection clamp DUO
to connect air termination conductors and down conductors with gutters.

Specification	Fit	PU	Ord. no.
Wire clamp - aluminium ;	ø 8 mm	25	1307 Z
Bead clamp - copper	Bead ø 15-20 mm		

Bimetal gutter clamp **upper piece:** Aluminium,
intermediate plate: Bimetall Al/Cu, **bottom piece:** both components copper.

Specification	Fit	PU	Ord. no.
Wire clamp aluminium ;	ø 8 mm	50	1300 Z
Bead clamp copper	Bead ø 10-20 mm		

Bimetal saddle clamp, for the connection between different materials.

Specification	Fit	PU	Ord. no.
for wire connections ø 8-10 mm aluminium ; on saddles up to 6 mm copper	ø 8-10 mm	50	1290 Z
for wire connections ø 8-10 mm copper on saddles up to 6 mm Steel, hot galvanized or aluminium	ø 8-10 mm	50	1297 Z

Bimetal gutter clamp - ideal



Ord. no. 111 674

Bimetal gutter clamp - slim



Ord. no. 111 679

Bimetal gutter connection clamp DUO



Ord. no. 1307 Z

Bimetal gutter clamp



Ord. no. 1300 Z

Bimetal saddle clamp



Ord. no. 1290 Z



Rod clamp



Ord. no. 1312

Snow guard clamp



Ord. no. 1311

Clamping shoe



Ord. no. 111 365

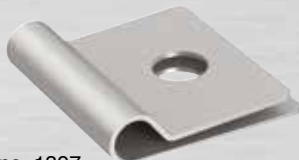

Ord. no. 1397



Ord. no. 111 364

Rod clamp

for connection of round conductors \varnothing 8-10 mm and rods \varnothing 16 and 20 mm.

Specification	Fit	PU	Ord. no.
Steel, hot galvanized	\varnothing 8-10 / \varnothing 16 mm	50	1312
Steel, hot galvanized	\varnothing 8-10 / \varnothing 20 mm	50	1313
Stainless steel V2A	\varnothing 8-10 / \varnothing 16 mm	50	1314
Stainless steel V2A	\varnothing 8-10 / \varnothing 20 mm	50	1315



Snow guard clamp, mounted with cylinder head screws M6 V2A.

Specification	Fit	PU	Ord. no.
Aluminium/stainless steel V2A	\varnothing 8-10 mm	50	1311
Copper	\varnothing 8-10 mm	50	1310

Clamping shoe, according to EN 62561-1

with one elongated hole \varnothing 9 x 12 mm for screwing on and four holes \varnothing 5.2 mm for riveting!

Specification	Fit	PU	Ord. no.
Steel, hot galvanized	\varnothing 8 mm	100	1365
Copper	\varnothing 8 mm	100	111 366
Aluminium	\varnothing 8 mm	100	111 365
Stainless steel V2A	\varnothing 8 mm	100	111 362



Clamping shoe, according to EN 62561-1

with one hole \varnothing 10.5 mm for screwing on.

Specification	Fit	PU	Ord. no.
Steel, hot galvanized	\varnothing 8 mm	100	1395
Copper	\varnothing 8 mm	100	1396
Aluminium	\varnothing 8 mm	100	1397
Stainless steel V2A	\varnothing 8 mm	100	111 363



Clamping shoe, according to EN 62561-1

with one hole \varnothing 11 mm for screwing and hexagon bolts M8.

Specification	Fit	PU	Ord. no.
Cast/hot galvanized	\varnothing 8-10 mm	100	111 364



Bridging bracket for the connection of metal structural claddings (Hole pattern: 4x ø 6.5 mm; 8x ø 5.2 mm)

Specification	Length	PU	Ord. no.
Aluminium	228 mm	100	1369
NEW! Aluminium	350 mm	100	111 403
Copper	228 mm	100	1370
Aluminium with centre hole ø 10.5 mm	228 mm	100	111 404
NEW! Aluminium with centre hole ø 10.5 mm	350 mm	100	111 402

Bridging cable, highly flexible, for the connection of metal structural claddings or as expansion piece 16 mm². Copper with aluminium cable lug; pressed airtight.

Specification	Length	PU	Ord. no.
For screws M8	400 mm	50	1371
Copper/aluminium	300 mm	100	1372
For screws M10	400 mm	50	1373
Copper/aluminium	300 mm	100	1374

Additional cable types, lengths and cross sections on request.

Bridging cable set, highly flexible bridging cable set 16 mm² for the connection of metal structural claddings, with Multi-Plus clamping jaws (ø 8 mm / flat).

Specification	Length	PU	Ord. no.
Cable copper/aluminium with	400 mm	25	910 096
two stainless steel V2A - clamps	300 mm	25	910 096 S

Additional cable types, lengths and cross sections on request.

Bridging braid, highly flexible, for the connection of metal structural claddings or as expansion piece (50 mm²). (Hole pattern: 4x ø 6.5 mm; 8x ø 5.1 mm; 2x ø 10.5 mm).

Specification	Length	PU	Ord. no.
Copper	180 mm	100	1375
Aluminium	180 mm	100	1376
Aluminium with central hole ø 10 mm	300 mm	100	911 688

Additional hole patterns on request.

Expansion piece, for the compensation of the temperature-dependent change in length of air termination conductors, e.g. connection with two multi clamps.

Specification	Length	Fit	PU	Ord. no.
Aluminium AlMgSi 0,5	600 mm	ø 8 mm	25	1380
Copper	600 mm	ø 8 mm	25	911 178

Drilling screw and blind rivet

Specification	Material	Dimensions	PU
DIN 7504 drilling screw WZ10	Stainless steel V2A-hexagonal	6.3 x 19 mm	100
Blind rivet DIN 7337	Stainless steel V2A	5.0 x 12 mm	500
	Stainless steel V2A/aluminium	5.0 x 12 mm	500

Additional dimensions on request.

Bridging bracket



Ord. no. 1369

Ord. no. 111 404

Bridging cable



Ord. no. 1371

Bridging cable set



Ord. no. 910 096

Bridging braid

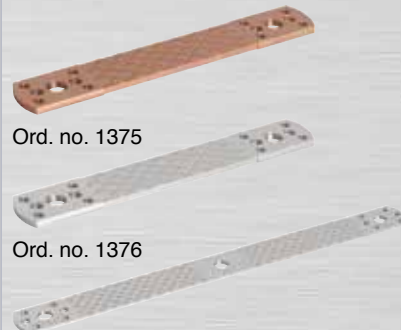

Ord. no. 1375

Ord. no. 1376

Ord. no. 911 688

Expansion piece



Ord. no. 1380

Drilling screw and blind rivet



DIN 7504

DIN 7337

Connection and terminal clamps



Number plate

Type A



Ord. no. 111 624



Ord. no. 1056

Type B



Ord. no. 111 640

Type C

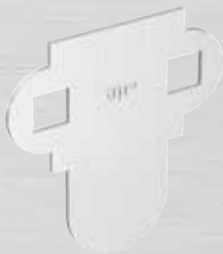

Ord. no. 111 620

Type D



Ord. no. 111 639



Ord. no. 111 629

Inspection door



Ord. no. 1044



Ord. no. 1045

Number plate

Number plate

marking of test joints at conductors and bars. Indicate the desired numbers on your order.

Specification	Fit	PU	Ord. no.
Type A: Number plate, without numbers , for flexible use with hand punches.			
Aluminium	ø 8-10 mm	100	111 624
Aluminium	ø 16 mm	200	111 625
Aluminium	fl. 30 mm	100	111 626
Copper	ø 8-10 mm	100	111 627
Copper	ø 16 mm	100	111 628
Hand punches 0-9, size 10 mm			
		1	1059
Type A: Number plate, including stamped in numbers, customised			
Aluminium	ø 8-10 mm	1	1056
Aluminium	ø 16 mm	1	1057
Aluminium	fl. 30 mm	1	1058
Copper	ø 8-10 mm	1	1060

Specification	PU	Ord. no.
Type B: Test plate, with hole spacing of 28 - 38 mm, suitable for number plates		
Aluminium	100	111 640
Copper	100	111 641

Specification	PU	Ord. no.
Type C: Test plate, suitable for Vario-Disconnecting clamp.		
Aluminium	100	111 620
Copper	100	111 623

Test badge ø 30 mm	20	111 629
Test badge with company logo on request.		

Specification	PU	Ord. no.
Type D: Test plate, for test badge up to ø 50 mm (e. g. VDB-test badge) with hole spacing of 28 - 38 mm, suitable for Vario-Disconnection clamp M8-Plus		
Stainless steel V2A	100	111 639
Stainless steel V2A / coppered	100	111 638

Specification	PU	Ord. no.
Test badge ø 30 mm	20	111 629
Test badge with company logo on request.		

Example of application:



Type B

Type C

Type D

Inspection door

Inspection door to be used for flush-mounted test joints.

Specification	Mounting dimensions	PU	Ord. no.
Steel, hot galvanized, stamped	155 x 205 mm	1	1044
Stainless steel V2A, stamped	155 x 205 mm	1	1040
Copper, patinated	155 x 205 mm	1	1050
Copper	155 x 205 mm	1	111 582
Steel, hot galvanized, stamped	140 x 250 mm	1	1041
Stainless steel V2A, stamped	140 x 250 mm	1	1045
Steel, hot galvanized with angular frame	150 x 200 mm	1	1054

Test joint box

Test joint box to be used for flush-mounted fitting and installation in concrete with integrated test joint and flexible connection cable for round conductor \varnothing 8-10 mm or flat strips.

Specification	PU	Ord. no.
Test joint box made of unbreakable plastic 142 x 142 x 70 mm with built-in test joint and flexible insulated connection rope. Cover made of stainless steel V2A	1	111 580

Example of application:

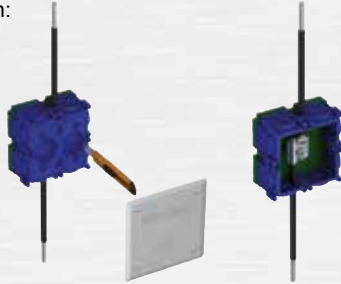

Earth electrode inspection housing

for underfloor installation. Heavy-duty type - can be driven over.

Specification	Mounting dimensions	PU	Ord. no.
Grey cast iron black varnished; opening: oval without test joint	230 x 150 x 120 mm	1	1055
with built-in test joint	230 x 150 x 120 mm	1	1043

Stainless steel V2A; opening: rectangular; **V2A**-cover; material thickness: **6 mm**

without test joint	260 x 210 x 120 mm	1	1055 S1
with built-in test joint	260 x 210 x 120 mm	1	1043 S1

Test joint box for flush-mounted installation on facades with external thermal insulation composite systems with the option of adjustment the installation depth.

Specification	Installation depth	PU	Ord. no.
Test joint box plastic (196 x 158 mm) low specification, without test joint. Conductor insert/perforations: round conductor: up to \varnothing 14.5 mm and strips: flat up to 30 x 5.0 mm Incl. V2A cover (220 x 180 mm) with neopren sealing, Plaster cover and installation set.	90 - 140 mm	1	111 585
Test joint box plastic (196 x 158 mm) high specification with removable spacer, insulation material, without test joint Conductor insert/perforations: Specification acc. to Ord. no. 111 585	130 - 320 mm	1	111 588
Test joint box plastic (196 x 158 mm) high specification with removable spacer, insulation material, and built-in test joint. Suitable for the connection of: round conductor: up to \varnothing 14.5 mm and strips: flat up to 30 x 5.0 mm Incl. V2A cover (220 x 180 mm) with neopren sealing, Plaster cover and installation set. The plastic is self-extinguishing and halogen-free. The V2A cover meets protection class IP65	130 - 320 mm	1	111 587

Spacer with insulation (Ord. no. 111 589) is available in single units. Price on request.

Cover with company logo on request. Price on request

Example of application:

Spacer (from Ord. no. 111 588)



Test joint box

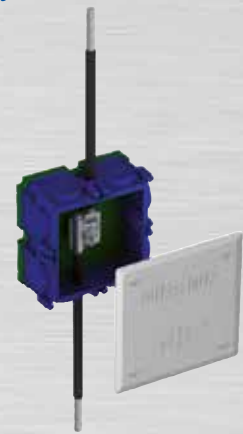

Ord. no. 111 580

Earth electrode inspection housing



Ord. no. 1055

Ord. no. 1055 S1

NEW!

Test joint box



Ord. no. 111 585



Ord. no. 111 587



Note: Test joint box with built-in equipotential bonding bar to be found on page 112.



Universal downpipe clamp



Ord. no. 111 212

Downpipe clamp



Ord. no. 111 100

Earthing pipe clamp



Ord. no. 111 650

Earthing pipe clamp



Ord. no. 111 261

Pipe clamp

Universal downpipe clamp (cutting to length as needed) - with holes \varnothing 9 mm, hexagonal screw M8 and nut. **Benefit:** Only two types, for all common diameters of downpipes.

Specification	Fit	PU	Ord. no.
Steel, hot galvanized	\varnothing 60 - 120 mm	25	111 214
Aluminium	\varnothing 60 - 120 mm	25	111 212
Copper	\varnothing 60 - 120 mm	25	111 210
Stainless steel V2A	\varnothing 60 - 120 mm	25	111 216
Steel, hot galvanized	\varnothing 90 - 150 mm	25	111 215
Aluminium	\varnothing 90 - 150 mm	25	111 213
Copper	\varnothing 90 - 150 mm	25	111 211
Stainless steel V2A	\varnothing 90 - 150 mm	25	111 217

Additional diameters on request.

Note: Fastener for insulated conductor mounting at a downpipe on page 49.

Downpipe clamp, hexagonal screw M8 and nut, according to EN 62561-1.

Specification	Fit	PU	Ord. no.
Steel, hot galvanized	\varnothing 100 mm	25	111 100
Steel, hot galvanized	\varnothing 120 mm	25	111 120
Copper	\varnothing 100 mm	25	111 205
Copper	\varnothing 120 mm	25	111 207

Additional dimensions with fixed measurements on request!

Note: Fastener for insulated conductor mounting at a downpipe on page 49.

Earthing pipe clamp for earthing connections with cross section of 6 - 50 mm², lengthwise and crosswise, for equipontial bonding.

Specification	Fit	Fit in inch	PU	Ord. no.
Steel, hot galvanized	\varnothing 13.5 - 17.2 mm	1/4" - 3/8"	100	111 650
Steel, hot galvanized	\varnothing 21.3 - 26.9 mm	1/2" - 3/4"	25	111 651
Steel, hot galvanized	\varnothing 33.7 mm	1"	50	111 652
Steel, hot galvanized	\varnothing 42.4 - 48.3 mm	1 1/4" - 1 1/2"	50	111 653
Copper	\varnothing 13.5 - 17.2 mm	1/4" - 3/8"	50	111 654
Copper	\varnothing 21.3 - 26.9 mm	1/2" - 3/4"	50	111 655
Copper	\varnothing 33.7 mm	1"	50	111 656

Earthing pipe clamp for connecting conductors with cross section of 6 - 50 mm².

Specification	Fit	Fit in inch	PU	Ord. no.
Copper/galvanized Sn	\varnothing 17.2 - 26.9 mm	3/8" - 3/4"	75	111 261
Copper/galvanized Sn	\varnothing 25 - 36 mm	ca. 3/4" - 1"	50	298 900



Earthing pipe clamp for antenna standpipes. For pipe diameters from 1" - 6", H-certified, for cross-section of connecting conductor from 10 mm² (ø 4 mm) to up to 50 mm² (ø 8 mm).

Specification	Fit	Fit in inch	PU	Ord. no.
Stainless steel V2A	ø 33.7 - 88.9 mm	1" - 3"	25	111 390
	ø 33.7 - 168 mm	1" - 6"	25	111 391
Steel, hot galvanized	ø 33.7 - 88.9 mm	1" - 3"	25	111 393
	ø 33.7 - 168 mm	1" - 6"	25	111 394

Earthing pipe clamp for steel and copper pipes from ø 17 mm up to ø 115 mm, for cross section of connecting conductors from 4 mm² (ø 2.3 mm) up to 50 mm² (ø 8 mm).

Specification	Fit	Fit in inch	PU	Ord. no.
Stainless steel V2A	ø 17 - 50 mm	3/8" - 1 1/2"	25	111 441
Stainless steel V2A	ø 27 - 115 mm	3/4" - 4"	25	111 442

Turnbuckle without strip for antenna standpipes for cross section of connecting conductors from 10 mm² (ø 4 mm) up to 50 mm² (ø 8 mm).

Specification	PU	Ord. no.
Stainless steel V2A	50	111 392
Steel, hot galvanized	50	111 395

Turnbuckle without strip for cross section of connecting conductors from 4 mm² (ø 2.3 mm) up to 50 mm² (ø 8 mm).

Specification	PU	Ord. no.
Stainless steel V2A	100	111 449

Stainless steel - tensioning strap in a practical box for individual cutting to lengths.

Specification	Fit	Length	PU	Ord. no.
Strap stainless steel V2A	22 x 0.4 mm	25 m	1	913 825
Strap stainless steel V2A	22 x 0.4 mm	50 m	1	913 831

Earthing pipe clamp for steel and copper pipes between ø 10 - 50 mm, for protective conductor connecting from 2.5 mm² up to 16 mm².

Specification	Fit	Fit in inch	PU	Ord. no.
Turnbuckle steel, hot galvanized,	ø 9.7 - 48.3 mm	1/8" - 1 1/2"	25	111 260
Strap bronze/nickel-plated	ø 9.7 - 114.3 mm	1/8" - 4"	25	111 440

Earthing pipe clamp for antenna standpipes



Ord. no. 111 390

Earthing pipe clamp



Ord. no. 111 442

Turnbuckle



Ord. no. 111 392

Ord. no. 111 449

Tensioning strap

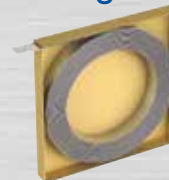

Ord. no. 913 825

Earthing pipe clamp



Ord. no. 111 260



Earthing pipe clamp



Ord. no. 1244

Earthing pipe clamp for pipes, made of Stainless steel V2A or steel, according to EN 62561-1.

Specification	Fit	Fit in inch	PU	Ord. no.
Steel, hot galvanized	ø 17.2 mm	3/8"	25	1240
Steel, hot galvanized	ø 21.3 mm	1/2"	25	1241
Steel, hot galvanized	ø 26.9 mm	3/4"	25	1242
Steel, hot galvanized	ø 33.7 mm	1"	25	1243
Steel, hot galvanized	ø 42.4 mm	1 1/4"	25	1244
Steel, hot galvanized	ø 48.3 mm	1 1/2"	25	1245
Steel, hot galvanized	ø 54.5 mm	1 3/4"	25	1249
Steel, hot galvanized	ø 60.3 mm	2"	25	1246
Steel, hot galvanized	ø 76.1 mm	2 1/2"	25	1247
Steel, hot galvanized	ø 88.9 mm	3"	25	1248
Steel, hot galvanized	ø 114.3 mm	4"	25	910 286

Stainless steel V2A	ø 17.2 mm	3/8"	25	111 240
Stainless steel V2A	ø 21.3 mm	1/2"	25	111 241
Stainless steel V2A	ø 26.9 mm	3/4"	25	111 242
Stainless steel V2A	ø 33.7 mm	1"	25	111 243
Stainless steel V2A	ø 42.4 mm	1 1/4"	25	111 244
Stainless steel V2A	ø 48.3 mm	1 1/2"	25	111 245
Stainless steel V2A	ø 54.5 mm	1 3/4"	25	111 249
Stainless steel V2A	ø 60.3 mm	2"	25	111 246
Stainless steel V2A	ø 76.1 mm	2 1/2"	25	111 247
Stainless steel V2A	ø 88.9 mm	3"	25	111 248
Stainless steel V2A	ø 114.3 mm	4"	25	910 572

Earthing pipe clamp also available in **copper**.

KS-Connector



Ord. no. 1360



Ord. no. 1359



Ord. no. 1462



KS-Connector

Clamping screw with hexagonal nut M10 suitable for round conductor ø 6-10 mm.

Specification	Fit	PU	Ord. no.
Steel, hot galvanized / aluminium clamping ring	ø 6-10 mm	100	1360
Steel, hot galvanized with square clamping bracket	ø 8-10 mm	100	1359
Stainless steel V2A coppered	ø 6-10 mm	100	1361
Stainless steel V2A	ø 6-10 mm	100	1362
Stainless steel V4A	ø 8-10 mm	100	1462

Multi-clamping jaw

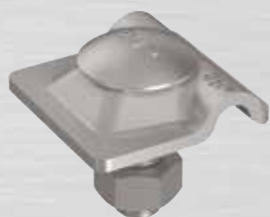

Ord. no. 1270 S3

Multi-clamping jaw,

suitable for round conductor up to ø 10 mm, with carriage bolt M10 and nut.

Specification	Fit	PU	Ord. no.
Steel, hot galvanized	ø 8 - 10 mm	100	1270 S3
Aluminium	ø 8 mm	100	1271 S
Stainless steel V2A	ø 8 - 10 mm	100	1273 S1



Earthing material



Earthing material



Earth lead-in rods



Ord. no. 101 000

Earth lead-in rods



Ord. no. 102 206 S1



Ord. no. 102 075

Terminal lug



Ord. no. 102 211



Ord. no. 102 213

Cross profiled earth rod



Ord. no. 110 200

Earth plate



Ord. no. 110 130

Earth lead-in rods

Earth lead-in rods, according to EN 62561-2, \varnothing 16 mm, with chamfered edges.

Specification	Length	Fit	PU	Ord. no.
Steel, hot galvanized	750 mm	\varnothing 16 mm	10	100 750
Steel, hot galvanized	1000 mm	\varnothing 16 mm	10	101 000
Steel, hot galvanized	1200 mm	\varnothing 16 mm	10	101 200
Steel, hot galvanized	1500 mm	\varnothing 16 mm	10	101 500
Steel, hot galvanized	2000 mm	\varnothing 16 mm	10	101 002
E-Copper	1000 mm	\varnothing 16 mm	10	101 005
E-Copper	1200 mm	\varnothing 16 mm	10	101 205
E-Copper	1500 mm	\varnothing 16 mm	10	101 505
Stainless steel V2A	1000 mm	\varnothing 16 mm	10	102 005
Stainless steel V2A	1200 mm	\varnothing 16 mm	10	102 205
Stainless steel V2A	1500 mm	\varnothing 16 mm	10	102 505
Stainless steel V4A	1000 mm	\varnothing 16 mm	10	103 137
Stainless steel V4A	1200 mm	\varnothing 16 mm	10	102 207
Stainless steel V4A	1500 mm	\varnothing 16 mm	10	910 347

Connection clamps for earth lead-in rods see page 101.

Earth lead-in rods with terminal lug for connecting down conductors to the earth termination system, corrosion resistant type, shrink-on tube insulated earth entry.

Specification	Fit / Length	PU	Ord. no.
Steel, hot galvanized	\varnothing 16 = 750 / 1000 = \varnothing 10 mm	10	102 075
Steel, hot galvanized	\varnothing 16 = 1000 / 1000 = \varnothing 10 mm	10	102 100
Steel, hot galvanized	\varnothing 16 = 1200 / 1000 = \varnothing 10 mm	10	102 120
Steel, hot galvanized	\varnothing 16 = 1500 / 1000 = \varnothing 10 mm	10	102 150
Stainless steel V2A	30 x 3.5 mm / 2000 mm	10	102 206
Stainless steel V4A	30 x 3.5 mm / 2000 mm	10	102 206 S1

Rods also available without insulation!

Note: Insulated down conductor (protection against touch voltage) see page 139.

Terminal lug, straightened, with PVC cover, 60 mm is stripped on one side.

Specification	Fit	Length	PU	Ord. no.
Steel, hot galvanized	\varnothing 10 mm	1500 mm	10	102 211
Steel, hot galvanized	\varnothing 10 mm	3200 mm	10	102 212

Additional lengths on request!

Terminal lug, stainless steel V4A, straightened.

Specification	Fit	Length	PU	Ord. no.
Stainless steel V4A	\varnothing 10 mm	1500 mm	10	102 213
Stainless steel V4A	\varnothing 10 mm	3200 mm	10	102 214
Stainless steel V4A	30 x 3.5 mm	1500 mm	10	102 233
Stainless steel V4A	30 x 3.5 mm	3200 mm	10	102 234

Additional lengths on request!

Cross profiled earth rod, 50x50x3 mm.

Specification	Length	PU	Ord. no.
Steel, hot galvanized	1000 mm	5	110 100
Steel, hot galvanized	1500 mm	5	110 150
Steel, hot galvanized	2000 mm	5	110 200
Steel, hot galvanized	2500 mm	5	110 205
Steel, hot galvanized	3000 mm	5	110 300

Additional lengths on request!

Earth plate according to EN 62305-3 Tab. 7.

Specification	Length	PU	Ord. no.
Steel, hot galvanized, with terminal lug (\varnothing 10 mm, insulated, length 1.5 m)	500x500x3 mm	1	110 140
	1000x500x3 mm	1	110 145
Copper, with welded connection cable (50 mm ² ; length 1.5 m)	500x500x2 mm	1	110 130
	1000x500x2 mm	1	110 135

Additional dimensions on request.



Clamping piece suitable for round conductors as a distance holder for installing foundation earth electrodes. **Benefits:** Infinitely adjustable height for different foundations (soil, blinding layer).

Specification	Fit	PU	Ord. no.
Steel, bare	ø 10 mm / fl. 30 x 3.5 mm	50	1321
Steel, hot galvanized	ø 10 mm / fl. 30 x 3.5 mm	50	1321 S

Example of application:



Spacer, for foundation earth electrodes. Suitable for ø 10 mm round conductors or 30 x 3.5 mm strip.

Specification	Length	PU	Ord. no.
Steel, hot galvanized	280 mm	50	1319

Clamping piece



Ord. no. 1321 S

Spacer



Ord. no. 1319

Sign "ACHTUNG! Blitzschutz/Erdung" and **Protective cap** for terminal lugs

Specification	Length	Fit	PU	Ord. no.
Sign PVC (printed on both sides)	200 x 50 mm	up to ø 10 mm or up to flat 40 x 4 mm	10	102 220

With company logo imprint upon request. Price upon request.

Sign and protective cap



Ord. no. 102 220

NEW! Protective cap plastic yellow	ø 10 mm or fl. 30 x 3.5 mm	50	102 219
---	----------------------------	----	---------

Application with ground strap:



Application with ground wire:



Ord. no. 102 219

Earthing material

Protection measures against step voltages in shelter hats

Steel grid panel as protection against step voltage.

Specification	Mesh size	Dimensions (L x W)	PU	Ord. no.
Stainless steel V4A (ø 4 mm)	250 x 250 mm	2.0 m x 1.0 m	1	912 125

NEW!

Steel grid panel

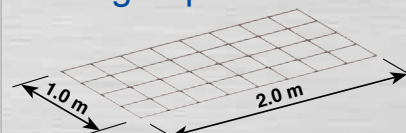

Ord. no. 912 125

Connection- / terminal clamp completely made of stainless steel V4A for steel grid panels.

Specification	Fit	PU	Ord. no.
Connection clamp: Multi-Mini	ø 4-6 / ø 4-6 mm	1	111 313
Terminal clamp: Multi-Mini	ø 10 / ø 4-6 mm	1	111 319

Connection- and Terminal clamp

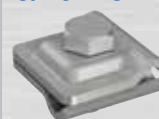

Ord. no. 111 313



Ord. no. 111 319



Diagonal cross clamp



Ord. no. 111 353

Connection clamp

Diagonal cross clamp, heavy-duty type

with two M10 screws for T-, cross- and parallel- connections, flat and round.

Specification			Fit	PU	Ord. no.
Steel, hot galvanized	two-part	flat/round	fl. 30 / ø 8-10 mm	50	1354
Steel, hot galvanized		flat/flat	fl. 30 / fl. 30 mm	50	111 352
Steel, hot galvanized		round/round	ø 8-10 / ø 8-10 mm	50	111 353
Steel, hot galvanized		flat/round	fl. 40 / ø 8-10 mm	25	111 354
Stainless steel V2A	two-part	flat/round	fl. 30 / ø 10 mm	50	2008
Stainless steel V2A		flat/flat	fl. 30 / fl. 30 mm	50	2015
Stainless steel V2A		round/round	ø 10 / ø 10 mm	50	2008 S
Stainless steel V4A	two-part	flat/flat	fl. 30 / fl. 30 mm	50	2015 S
Stainless steel V4A		round/flat	ø 10 / fl. 30 mm	50	2008 S1
Stainless steel V4A		round/round	ø 10 / ø 10 mm	50	2008 S2



flat/flat parallel connector



flat/flat cross connector



flat/flat/round parallel cross connector



round/round (ø10mm) cross connector



flat/flat/round parallel connector

USV-clamp



Ord. no. 111 425

USV - clamp

Easy-to-assemble connection system e.g. for earthing conductors in concrete.

Benefits: • considerably shorter and easier installation process • universal use.

Specification		Fit	PU	Ord. no.
Steel, hot galvanized	flat/round/flat	30 / ø 8-10 / 30 mm	50	111 425
Stainless steel V2A	flat/round/flat	30 / ø 8-10 / 30 mm	50	111 426



flat/flat connection



flat/flat T-connection



flat/round ø 8-10 parallel connection



flat/flat connection and round T-connection



flat/flat/round cross connection

Multi-clamp ø 10 mm



Ord. no. 1278

Multi-clamp ø 10 mm, heavy-duty type

for the universal use as T-, cross-, parallel- and end to end - connection.

Specification	Carriage bolt with nut	Fit	PU	Ord. no.
Steel, hot galvanized	Steel, hot galvanized	ø 10 mm	75	1278
Stainless steel V2A	Stainless steel V2A	ø 10 mm	75	1279
Stainless steel V4A	Stainless steel V2A	ø 10 mm	75	1279 S
Copper	Coppered	ø 10 mm	75	111 280

Diagonal swivel cross clamp

NEW!

Benefits:

- No clamp disassembly required.
- Easier installation because of swivelling opening.
- Low construction height after installation.
- Two hexagonal screws M10 (wrench width 17) .
- T-, cross-, parallel-, and diagonal- connections are possible.

Diagonal swivel cross clamp

for a fast and simple connection of round and flat material

Specification	Fit	PU	Ord. no.
Steel, hot galvanized	fl. 30 / ø 8-10 mm	25	111 790
Steel, hot galvanized	ø 8-10 mm / ø 8-10 mm	25	111 791
Stainless steel V2A	fl. 30 / ø 8-10 mm	25	111 792
Stainless steel V2A	ø 8-10 mm / ø 8-10 mm	25	111 793
Stainless steel V4A	fl. 30 / ø 8-10 mm	25	111 794
Stainless steel V4A	ø 8-10 mm / ø 8-10 mm	25	111 795



Diagonal swivel cross clamp



Ord. no. 111 790



Ord. no. 111 791

Connecting clamp for reinforcement

NEW!

Benefits:

- Easier installation because of swivelling opening.
- No clamp disassembly required.
- Large clamping area flat/round (Ø 10 / fl. 40 mm) is possible with the reinforcement (up to Ø 40 mm).
- T-, cross-, parallel-, and diagonal- connections are possible.

Connecting clamp for reinforcement for the fast and easy connection of round or flat conductors with the reinforcement.

Specification	Fit		PU	Ord. no.
	Reinforcement	Conductor		
Steel, bare	ø 10 - 20 mm	fl. 30 / 40 mm	25	111 690
Steel, bare	ø 20 - 40 mm	fl. 30 / 40 mm	25	111 691
Steel, bare	ø 10 - 20 mm	ø 10 mm and/or fl. 30 / 40 mm	25	111 692
Steel, bare	ø 20 - 40 mm	ø 10 mm and/or fl. 30 / 40 mm	25	111 693
Steel, hot galvanized	ø 10 - 20 mm	fl. 30 / 40 mm	25	111 694
Steel, hot galvanized	ø 20 - 40 mm	fl. 30 / 40 mm	25	111 695
Steel, hot galvanized	ø 10 - 20 mm	ø 10 mm and/or fl. 30 / 40 mm	25	111 696
Steel, hot galvanized	ø 20 - 40 mm	ø 10 mm and/or fl. 30 / 40 mm	25	111 697

Connecting clamp for reinforcement



Ord. no. 111 690



Ord. no. 111 696



Reinforcement terminal clamps **NEW!**

Benefits:

- No loose components during installation.
- Low construction height after installation.
- All existing connection types such as T-, cross-, parallel- and diagonal- connections are possible.
- Various diameters are possible e.g. flat 30x3.5 mm and \varnothing 5 - 25 mm.
- Only one screw M10 = central contact pressure.
- Optimal economic use for planning, stockkeeping, calculation and accounting.

Multi-flat+round terminal clamp



Ord. no. 111 796



Ord. no. 111 799

Multi-flat+round terminal clamp (fl. 30 x 3.5 / \varnothing 5 - 25 mm)

for a fast and easy connection of flat conductor with reinforcement.

Specification	Fit		PU	Ord. no.
	Reinforcement	Conductor		
Steel, bare	\varnothing 5 - 25 mm	fl. 30 x 3.5 mm	25	111 796
Steel, hot galvanized	\varnothing 5 - 25 mm	fl. 30 x 3.5 mm	25	111 797
Steel, bare with double terminal clamp \varnothing 8-10 mm	\varnothing 5 - 25 mm	fl. 30 x 3.5 mm \varnothing 10 mm	25	111 798
Steel, hot galvanized with double terminal clamp \varnothing 8-10 mm	\varnothing 5 - 25 mm	fl. 30 x 3.5 mm \varnothing 10 mm	25	111 799

Specification in **stainless steel** on request.

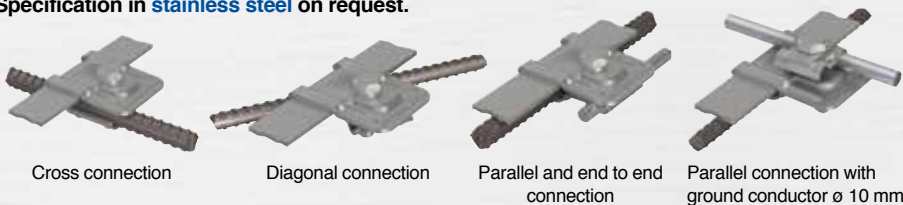

Cross connection

Diagonal connection

Parallel and end to end connection

Parallel connection with ground conductor \varnothing 10 mm

Multi-flat+round terminal clamp – now also available with countersunk screw and carriage bolt. For a quick and easy connection of flat conductor with the reinforcement.

Other benefits:

Benefit of a countersunk screw with hexagon socket:

- Extremely low construction height for low concrete coverage.

Benefit of a carriage bolt:

- Faster component installation.

Benefit of a turned carriage bolt:

- Installation of flat conductor underneath reinforcement is possible.

Multi-flat+round terminal clamp



Ord. no. 111 800



Ord. no. 111 802



Ord. no. 111 804

Multi-flat+round terminal clamp (fl. 30 x 3.5 / \varnothing 5 - 16 mm)

for a quick and easy connection of flat conductor with reinforcement.

Specification Countersunk screw with internal hexagon	Fit		PU	Ord. no.
	Reinforcement	Conductor		
Steel, bare	\varnothing 5 - 16 mm	fl. 30 x 3.5 mm	25	111 800

Multi-flat+round terminal clamp (fl. 30 x 3.5 / \varnothing 5 - 16 mm)

For a quick and easy connection of flat conductor with reinforcement.

Specification with carriage bolt	Fit		PU	Ord. no.
	Reinforcement	Conductor		
Steel, bare (hexagonal nut on the side of the flat conductor)	\varnothing 5 - 16 mm	fl. 30 x 3.5 mm	25	111 802
Steel, bare (hexagonal nut on the reinforcement side)	\varnothing 5 - 16 mm	fl. 30 x 3.5 mm	25	111 804

Multi-Max reinforcement clamp 50x50 mm NEW!

Benefits:

- No loose components during installation.
- Only one screw M12 = central contact pressure.
- All existing connection types such as T-, cross-, parallel- and diagonal- connection are possible.
- Suitable for conductors flat 30x3.5 mm or Ø 10 mm.
- Low construction height.

Multi-Max reinforcement clamp 50x50 mm

Specification with hexagon bolt	Fit		PU	Ord. no.
	Reinforcement	Conductor		
Steel, bare	ø 4-16 mm	fl. 30 x 3.5 mm or ø 10 mm	50	111 806
Steel, hot galvanized	ø 4-16 mm	fl. 30 x 3.5 mm or ø 10 mm	50	111 816

Benefit of a carriage bolt:

- Faster component installation.

Benefit of a turned carriage screw:

- Installation of conductor underneath reinforcement is possible.

Specification with carriage bolt				
Steel, bare (hexagonal nut on the side of the ground strap)	ø 4-16 mm	fl. 30 x 3.5 mm or ø 10 mm	50	111 807
Steel, hot galvanized (hexagonal nut on the side of the ground strap)	ø 4-16 mm	fl. 30 x 3.5 mm or ø 10 mm	50	111 817
Steel, bare (hexagonal nut on the armour side)	ø 4-16 mm	fl. 30 x 3.5 mm or ø 10 mm	50	111 809
Steel, hot galvanized (hexagonal nut on the armour side)	ø 4-16 mm	fl. 30 x 3.5 mm or ø 10 mm	50	111 819

Benefit of a threaded bolt:

- Assembly possible in two steps:
 1. Connect the foundation earth electrode (round) to the reinforcement
 2. Connect and fix the fixed earthing terminal to the reinforcement

Specification with threaded bolt				
Steel, bare with threaded bolt M10 x 20	ø 4-16 mm	fl. 30 x 3.5 mm or ø 10 mm	50	111 808
Steel, hot galvanized with threaded bolt M10 x 60	ø 4-16 mm	fl. 30 x 3.5 mm or ø 10 mm	50	111 818

Multi-Max reinforcement clamp 75x75 mm NEW!

Benefits:

- No loose components during installation.
- Only one screw M12 = central contact pressure.
- All existing connection types such as T-, cross-, parallel- and diagonal- connection are possible.
- Various diameters from ø 8 mm to ø 32 mm are possible.

Multi-Max reinforcement clamp 75x75 mm

Specification	Fit		PU	Ord. no.
	Upper part	Bottom part		
Steel, bare with hexagon bolt	ø 8-16 mm / ø 15-32 mm	ø 8-16 mm / ø 15-27 mm	10	111 810
Steel, hot galvanized with hexagon bolt	ø 8-16 mm / ø 15-32 mm	ø 8-16 mm / ø 15-27 mm	10	111 820

Multi-Max reinforcement clamp

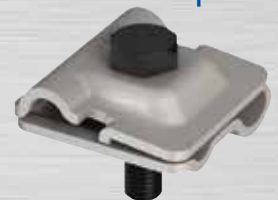

Ord. no. 111 806



Ord. no. 111 807



Ord. no. 111 809



Ord. no. 111 808

Multi-Max reinforcement clamp



Ord. no. 111 810



Smart connector

NEW!



Ord. no. 111 417



Ord. no. 111 408

Smart connector, to connect reinforcement and round conductors with clamping screw M10.

Specification	Fit		PU	Ord. no.
	Reinforcement	Conductor		
Steel, bare	ø 6-16 mm	ø 10 mm	50	111 416
Steel, hot galvanized	ø 6-16 mm	ø 10 mm	50	111 417

Specification	Fit		PU	Ord. no.
	Reinforcement	Conductor		
Steel, bare	ø 6-10 mm	ø 10 mm	100	111 406
Steel, hot galvanized	ø 6-10 mm	ø 10 mm	100	111 407
Stainless steel V2A	ø 6-10 mm	ø 10 mm	100	111 408
Stainless steel V4A	ø 6-10 mm	ø 10 mm	100	111 409



Cross clamp
ø 10 / ø 16 mm



Cross clamp
ø 6-10 / ø 10 mm



Parallel clamp
ø 10 / ø 10 mm



End to end connection
ø 10 / ø 10 mm

Connecting clamp small type

NEW!



Ord. no. 111 414

Application example:



Benefits:

- Cost-efficient solution for connections of flat conductor with small reinforcement steel.
- Compact design.
- Only one screw M10.

Connecting clamp small type for different combinations, with clamp screw M10

Specification	Fit		PU	Ord. no.
	Reinforcement	Conductor		
Steel, bare	flat / flat	fl. 30 x 3.5 mm / fl. 30 x 3.5 mm	25	111 413
	flat / round	fl. 30 x 3.5 mm / ø 6 - 12 mm		
Steel, hot galvanized	flat / flat	fl. 30 x 3.5 mm / fl. 30 x 3.5 mm	25	111 414
	flat / round	fl. 30 x 3.5 mm / ø 6 - 12 mm		

Connecting clamp



Ord. no. 111 420

Connecting clamp



Ord. no. 111 421 S2

Connecting clamp for the connection of **flat conductors with the reinforcement.**

Specification	Fit		PU	Ord. no.
	Reinforcement	Conductor		
Steel, hot galvanized	ø 10 - 29 mm	fl. 30/40 mm	25	111 421
Steel, bare	ø 10 - 29 mm	fl. 30/40 mm	25	111 420

Connecting clamp for the connection of **round conductors with the reinforcement.**

Specification	Fit		PU	Ord. no.
	Reinforcement	Conductor		
Steel, hot galvanized	ø 6 - 25 mm	ø 10 mm	25	111 421 S2
Steel, bare	ø 6 - 25 mm	ø 10 mm	25	111 420 S2



Connecting clamp

Connecting clamp for different combinations, ϕ 6 - 20 mm and flat 30 x 3.5 mm or ϕ 10 mm; with M10 clamping screw.

Specification	Reinforcement	Fit		PU	Ord. no.
		Conductor			
with clamping bracket (Type A)					
Steel, hot galvanized	ϕ 6 - 20 mm	fl. 30x3.5 mm or ϕ 10 mm		25	111 424
Steel, bare	ϕ 6 - 20 mm	fl. 30x3.5 mm or ϕ 10 mm		25	111 423
Stainless steel V2A	ϕ 6 - 20 mm	fl. 30x3.5 mm or ϕ 10 mm		25	111 424 S1
*without clamping bracket (Type B)					
Steel, hot galvanized	ϕ 6 - 20 mm	fl. 30x3.5mm		25	111 424 S
Steel, bare	ϕ 6 - 20 mm	fl. 30x3.5mm		25	111 423 S
Stainless steel V2A	ϕ 6 - 20 mm	fl. 30x3.5mm		25	111 424 S2

ϕ 10 / fl. 30 x 3.5 mm ϕ 16 / ϕ 10 mm ϕ 16 / fl. 30 x 3.5 mm fl. 30 x 3.5 / fl. 30 x 3.5 mm ϕ 20 / fl. 30 x 3.5 mm

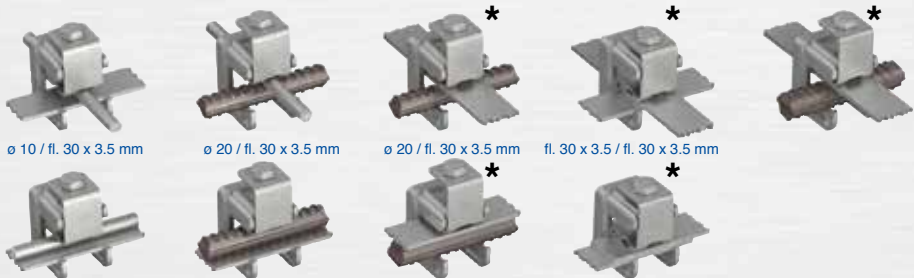

* Connection without clamping bracket also possible (Type B).

Connecting clamp with spring

Connecting clamp with bracket and spring for different combinations; with one clamping screw M10.

Specification	Reinforcement	Fit		PU	Ord. no.
		Conductor			
Steel, bare	ϕ 6 - 25 mm	ϕ 10 mm		25	111 330
Steel, hot galvanized	ϕ 6 - 25 mm	ϕ 10 mm		25	111 331
Specification					
Specification	Reinforcement	Fit		PU	Ord. no.
Steel, bare	ϕ 6 - 20 mm	fl. 30x3.5 mm oder ϕ 10 mm		25	111 333
Steel, hot galvanized	ϕ 6 - 20 mm	fl. 30x3.5 mm oder ϕ 10 mm		25	111 334
Stainless steel V2A	ϕ 6 - 20 mm	fl. 30x3.5 mm oder ϕ 10 mm		25	111 332

Mounting aid

Mounting aid for connecting clamp (e.g. ord. no. 111 330) - for an easy mounting in difficult accessible reinforcement cages.

Specification	Weight	Length	PU	Ord. no.
Consisting of a magnetic socket wrench width 17. Power-transmitting parts made of stainless steel V2A. Hexagon wrench width 10 used as drive; can be used in a drill if necessary.	210 g	40 mm	1	110 241
Equal to ord. no. 110 241, but with free-running handle	550 g	400 mm	1	110 242
	900 g	800 mm	1	110 243

Connecting clamp

(J&P utility patent)
Type A



Ord. no. 111 424

Type B



Ord. no. 111 424 S

Connecting clamp with spring

NEW!



Ord. no. 111 330



Ord. no. 111 334

Mounting aid

NEW!



Ord. no. 110 241



Ord. no. 110 242





Cross connector two-part and three-part



Ord. no. 1322



Ord. no. 1329

Cross connector, two-part and three-part.

Specification		Fit	PU	Ord. no.
Steel, hot galvanized	two-part	round/flat	ø 8-10/30 mm	25 1322
Steel, hot galvanized		round/round	ø 8-10/ø 8-10 mm	25 1329
Steel, hot galvanized		flat/flat	30/30 mm	25 1323
Steel, hot galvanized		flat/flat	40/40 mm	25 900 047
Steel, hot galvanized		round/flat	ø 8-10/40 mm	25 910 007
Steel, hot galvanized		round/round	ø 8-10/ø 16 mm	25 1324
Steel, hot galvanized	three-part	round/flat	ø 8-10/30 mm	25 1325
Steel, hot galvanized		flat/flat	30/30 mm	25 1326
Steel, hot galvanized		round/round	ø 8-10/ø 8-10 mm	25 1327 S
Steel, hot galvanized		round/round	ø 8-10/ø 16 mm	25 1327
Stainless steel V2A	two-part	flat/flat	30/30 mm	25 2004
Stainless steel V2A		round/flat	ø 8-10/30 mm	25 2003
Stainless steel V2A		round/round	ø 8-10/ø 8-10 mm	25 2005 S
Stainless steel V2A		round/round	ø 8-10/ø 16 mm	25 2005
Stainless steel V4A	two-part	flat/flat	30/30 mm	25 910 494
Stainless steel V4A		round/flat	ø 8-10/30 mm	25 910 259
Stainless steel V4A		round/round	ø 8-10/ø 8-10 mm	25 910 260

Wedge connector



Ord. no. 1320



Ord. no. 1320 S

Wedge connector with safety catch, for T-, cross- and parallel- connections

Installation: Wedge has to be installed crosswise to the conductor.

Specification	Fit	PU	Ord. no.
Steel, electro-galvanized	ø 10/fl. 30 mm or fl. 30/fl. 30 mm	40	1320
Steel, electro-galvanized with hexagonal screw	ø 10/fl. 30 mm or fl. 30/fl. 30 mm	40	1320 S

Example of applications:



ES-clamp

NEW!

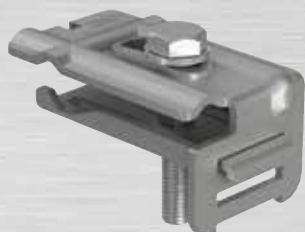

Ord. no. 111 698

ES-reinforcement clamp, for connection of flat and round conductors to reinforcement steel

Specification	Reinforcement	Fit		PU	Ord. no.
		Conductor			
Steel, bare	ø 10 - 40 mm	ø 10 / fl. 30 - 40 mm		25	111 698
Steel, hot galvanized	ø 10 - 40 mm	ø 10 / fl. 30 - 40 mm		25	111 699



fl. 30 x 3.5 / ø 12 mm

ø 10 / ø 28 mm

ø 10 / ø 28 mm

fl. 30 x 3.5 / ø 28 mm



Earth rods

Modular plugable according to EN 62561-2.

Specification	Corresponding driving steel darts	Fit	PU	Ord. no.
Earth rod:				
Type A, steel, hot galvanized with 3-fold knurling	2058	ø 20/1000 mm	10	110 029
	2058	ø 20/1500 mm	10	110 020
	2059	ø 25/1500 mm	5	110 027
	2059	ø 25/1000 mm	5	110 019
Type A, stainless steel V2A	2058	ø 20/1500 mm	10	110 120
	2058	ø 20/1000 mm	10	910 095
Type A, stainless steel V4A	2058	ø 20/1500 mm	10	110 121
	2058	ø 20/1000 mm	10	110 122
Type BP, Steel, hot galvanized with lead ball	2059	ø 25/1000 mm	5	110 024
Tubular earth rod:				
Type C, steel, hot galvanized	2058	ø 25/1500 mm	10	110 021
Type C, stainless steel V2A	2059	ø 25/1500 mm	10	110 026
Type C, stainless steel V4A	2059	ø 25/1500 mm	10	110 018

Driving steel darts, suitable for earth rods.

Specification		PU	Ord. no.
Driving steel darts for ER ø 20 mm Type A ø 25 mm Type C St/hot galvanize (Ord. no. 110 021)	Steel, electro galvanized	1	2058
Driving steel darts for ER ø 25 mm Type A / Type BP / Type C stainless steel (Ord. no. 110 018; 110 026)	Steel, electro galvanized	1	2059

Connection clamp with 2 screws M10 suitable for parallel- and cross- connections.

Specification		Fit	PU	Ord. no.
Steel, hot galvanized	three-part	ø 8-10 & fl. 30-40/ ø 16 mm	25	111 355
Steel, hot galvanized		ø 8-10 & fl. 30-40/ ø 20 mm	25	111 356
Steel, hot galvanized		ø 8-10 & fl. 30-40/ ø 25 mm	25	111 357
Stainless steel V2A	two-part	ø 10 & fl. 30-40/ ø 16 mm	25	2009
Stainless steel V2A		ø 10 & fl. 30-40/ ø 20 mm	25	2010
Stainless steel V2A		ø 10 & fl. 30-40/ ø 25 mm	25	2011
Stainless steel V4A	two-part	ø 10 & fl. 30-40/ ø 16 mm	25	2013
Stainless steel V4A		ø 10 & fl. 30-40/ ø 20 mm	25	2017
Stainless steel V4A		ø 10 & fl. 30-40/ ø 25 mm	25	2031

Connection clamp, suitable for earth rod and ø 10 mm round conductors.

Specification	Fit	PU	Ord. no.
Steel, hot galvanized	ø 8-10 & ER ø 20 mm	50	2020
Stainless steel V4A	ø 8-10 & ER ø 20 mm	50	2018
Steel, hot galvanized	flat 30x3.5 mm; ø 10 & ER ø 25 mm	25	2021
Stainless steel V4A	flat 30x3.5 mm; ø 10 & ER ø 25 mm	25	2025

Earth rod and tubular earth rod

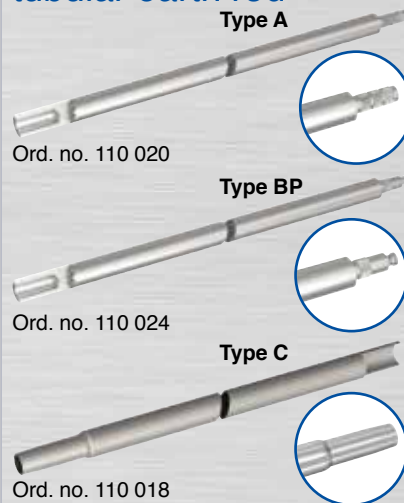

Driving steel darts



Connection clamp for earth rod and earth lead-in rod



Connection clamp for earth rod





Earth rod driver



Ord. no. 111 461

Ord. no. 111 462

Driving head/ Adapter



Ord. no. 2056

Ord. no. 111 465

Earthing material

Expansion piece



Ord. no. 111 445

Expansion strip



Ord. no. 111 448

Earth rod driver

Specification		PU	Ord. no.
Brand:	HITACHI	1	111 460
Type:	H 90 SE electric motor		
Power:	1450 Watt		
Single stroke energy:	55 Joule		
Weight:	32 kg	1	111 461
Brand:	WACKER		
Type:	BH 55 gasoline motor		
Single stroke energy:	55 Joule		
Weight:	24 kg		

Driving heads and adapters

for earth rod driver, suitable for earth rods and tubular earth rods.

Specification		Fit	PU	Ord. no.
Driving head for	ER Type A (ø 20 mm)	ø 20 mm	1	2056
Driving head for	ER Type A, Type BP (ø 25 mm)	ø 25 mm	1	2057
Driving head for	ER Type C (tubular earth rod)	ø 25 mm	1	111 458
Adapter for Hitachi				
	ER Type A (ø 20 mm)	ø 20 mm	1	111 463
	ER Type A, Type BP (ø 25 mm)	ø 25 mm	1	111 464
	ER Type C (tubular earth rod)	ø 25 mm	1	111 465
Adapter for Wacker				
	ER Type A (ø 20 mm)	ø 20 mm	1	111 466
	ER Type A, Type BP (ø 25 mm)	ø 25 mm	1	111 467
	ER Type C (tubular earth rod)	ø 25 mm	1	111 468
Adapter for Bosch GSH27 / USH27				
	ER Type A (ø 20 mm)	ø 20 mm	1	111 479
	ER Type A, Type BP (ø 25 mm)	ø 25 mm	1	111 479 S1
	ER Type C (tubular earth rod)	ø 25 mm	1	111 479 S

Additional adapters on request.

Expansion piece

as bridging component for expansion joints of foundation earth electrode

Specification		Fit	PU	Ord. no.
Strip	Block			
Stainless steel V2A	polystyrene	30 x 3.5 mm	1	111 445
Stainless steel V4A	polystyrene	40 x 4 mm	1	111 445 S

Example of application:

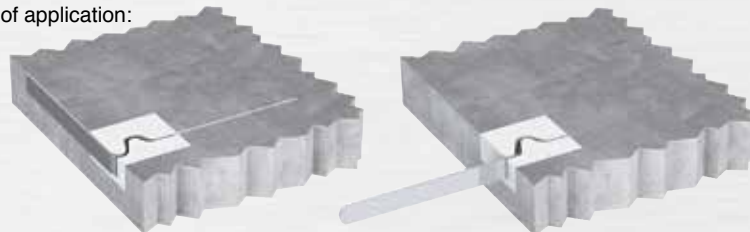

Expansion strip, for a connection of the foundation earth electrode outside the concrete.

Specification	Length	Fit	PU	Ord. no.
Aluminium	250 mm	40 x 5.0 mm	1	111 448

Additional lengths on request!

Fixed earthing terminals and connection sets

A complete range for connecting equipotential bonding conductors to the foundation earth electrode, to the reinforcement and to the lightning protection system.

- Benefits:**
- Easy assembly due to flexible connections.
 - Corrosion-resistant, reliable connections due to stainless steel contacts.
 - Also suitable as test joint.

Fixed earthing terminal,

for the connection of earth termination systems to reinforcement and down conductors.

Specification	Screw-sets (page 108) optional		Ord. no.
	connection thread	set-no.	
Completely made of stainless steel			
Contact plate ø 80 mm stainless steel V4A with 3 mounting holes ø 4 mm; with terminal stud ø 10 mm; total length 190 mm	M12	set 03	112 000 
NEW Equal to ord. no. 112 000, but with foam cover	M10	set 02	
M12	set 03	112 200	
M10	set 02		
Made of stainless steel / steel			
NEW Contact plate ø 80 mm stainless steel V4A with 3 mounting holes ø 4 mm; threaded sleeve ø 16 mm; with terminal stud ø 10 mm steel , total length 190 mm; with foam cover	M12	set 03	112 150 
M10	set 02		
NEW Equal to ord. no. 112 150, but with threaded sleeve ø 20 mm and terminal stud ø 12 mm steel	M12	set 03	112 151
M10	set 02		
NEW Equal to ord. no. 112 150, but with threaded sleeve ø 20 mm and terminal stud ø 10 mm steel	M12	set 03	112 152
M10	set 02		
NEW Contact plate ø 80 mm stainless steel V4A with 3 mounting holes ø 4 mm; threaded sleeve ø 25 mm; with terminal stud ø 12 mm steel , total length 190 mm; with foam cover	M16	set 06	112 153

Fixed earthing terminal with terminal stud

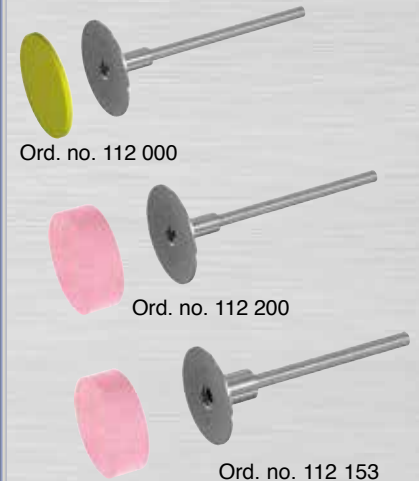

Fixed earthing terminal,

for the connection of earth termination systems to reinforcement and down conductors.

Specification	Screw-sets (page 108) optional		Ord. no.
	connection thread	set-no.	
Contact plate ø 80 mm stainless steel V4A with 3 mounting holes ø 4 mm.	M10	set 01	112 007 
Equal to ord. no. 112 007	M12	set 03	112 004
NEW Equal to ord. no. 112 007, but with foam cover	M10	set 01	112 207
NEW Equal to ord. no. 112 004, but with foam cover	M12	set 03	112 204

Connection cable with cable lug on request!

Fixed earthing terminal for flexible connection

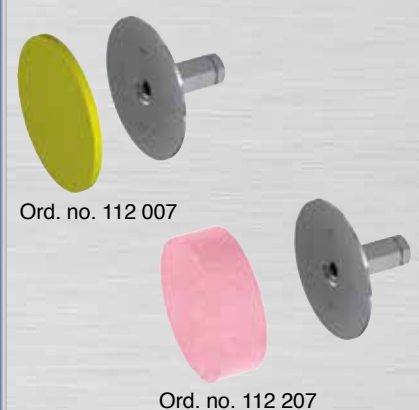

Fixed earthing terminal M16 for flexible connection 70 mm²,

for the connection of earth termination systems to reinforcement and down conductors.

Specification	Screw-sets (page 108) optional		Ord. no.
	connection thread	set-no.	
NEW Contact plate ø 80 mm stainless steel V4A with 3 mounting holes ø 4 mm. and connection part 70 mm ² Cu/Sn 400 mm long	M16	set 05	112 155 

Note:

The value for I_k = short circuit current (50Hz)(1s; ≤ 300°C) can be found in the index directory starting from page 184.

Fixed earthing terminal for flexible connection





Fixed earthing terminal with welded cross clamp



Ord. no. 112 008

Ord. no. 112 154

Fixed earthing terminal with red plastic ring

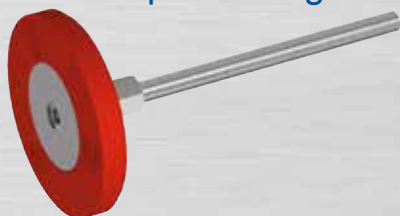

Ord. no. 112 020

Fixed earthing terminal for flexible connection

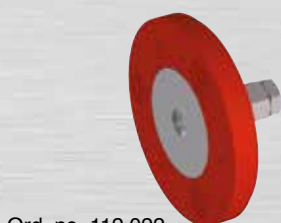

Ord. no. 112 022

Fixed earthing terminal with welded cross clamp

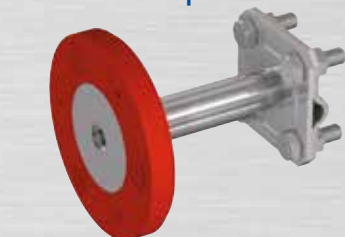

Ord. no. 112 024

Fixed earthing terminal, for the connection of earth termination systems to reinforcement and down conductors.

Specification	Screw-sets (page 108) optional		Ord. no.
	connection thread	set-no.	
Contact plate \varnothing 80 mm stainless steel V4A with 3 mounting holes \varnothing 4 mm; with terminal stud and cross clamp for flat 30 mm/ \varnothing 8-10 mm	M10	set 01	112 008
Equal to ord. no. 112 008,	M12	set 03	112 002
NEW! Equal to ord. no. 112 008, but with foam cover	M10	set 01	112 208
NEW! Equal to ord. no. 112 002, but with foam cover	M12	set 03	112 202
NEW! Contact plate \varnothing 80 mm Stainless steel V4A with 3 mounting holes \varnothing 4 mm; with terminal stud and adjustable cross clamp for flat 40 mm/ \varnothing 8-10 mm	M16	set 06	112 154
	M12	set 04	

Fixed earthing terminal, for the connection of earth termination systems to reinforcement and down conductors.

Specification	Screw-sets (page 108) optional		Ord. no.
	connection thread	set-no.	
Contact plate \varnothing 50 mm stainless steel V4A Red plastic ring, \varnothing 95 mm with 3 mounting holes \varnothing 3.4 mm; with clamping pin \varnothing 10 mm, total length 200 mm	M10	set 01	112 020
Equal to ord. no. 112 020,	M12	set 03	112 021
NEW! Equal to ord. no. 112 020, but with foam cover	M10	set 01	112 220
NEW! Equal to ord. no. 112 021, but with foam cover	M12	set 03	112 221

Connection with diagonal cross clamp possible, see page 94!

Fixed earthing terminal, for the connection of earth termination systems to reinforcement and down conductors.

Specification	Screw-sets (page 108) optional		Ord. no.
	connection thread	set-no.	
Contact plate \varnothing 50 mm stainless steel V4A Red plastic ring, \varnothing 95 mm with 3 mounting holes \varnothing 3.4 mm; for connection with cable lug or steel strip	M10	set 01	112 022
Equal to ord. no. 112 022,	M12	set 03	112 023
NEW! Equal to ord. no. 112 022, but with foam cover	M10	set 01	112 222
NEW! Equal to ord. no. 112 023, but with foam cover	M12	set 03	112 223

Connection cable with cable lug on request!

Fixed earthing terminal, for the connection of earth termination systems to reinforcement and down conductors.

Specification	Screw-sets (page 108) optional		Ord. no.
	connection thread	set-no.	
Contact plate \varnothing 50 mm stainless steel V4A Red plastic ring, \varnothing 95 mm with 3 mounting holes \varnothing 3.4 mm; with connection stud and cross clamp for fl. 30 mm / \varnothing 8-10 mm	M10	set 01	112 024
Equal to ord. no. 112 024,	M12	set 03	112 025
NEW! Equal to ord. no. 112 024, but with foam cover	M10	set 01	112 224
NEW! Equal to ord. no. 112 025, but with foam cover	M12	set 03	112 225

Adjustable wall bushings

Wall bushing (adjustable) for subsequent

water pressure-tight connection of earthing and equipotential bonding conductors.

Specification	Wall thickness	PU	Ord. no.
Stainless steel V2A			
Thread: M12	100-200 mm	1	112 010
O-Ring-seal on both sides	180-300 mm	1	112 011
Water pressure-tight & corrosion-proof	300-400 mm	1	112 012
Diameter of flange: ø 80 mm	400-600 mm	1	112 013
Connection with, e.g. connection angle ord. no. 112 018.			

Specification	Wall thickness	PU	Ord. no.
NEW! Stainless steel V4A; thread: M16	100-200 mm	1	112 156
O-Ring-seal on both sides	180-300 mm	1	112 157
Water pressure-tight & corrosion-proof	300-400 mm	1	112 158
Diameter of flange: ø 80 mm	400-600 mm	1	112 159
Connection with, e.g. connection angle ord. no. 112 046.			

Wall bushing (adjustable) with water barrier, for water pressure-tight connection of earthing and equipotential bonding conductors for concrete with a high water penetration resistance (e.g. waterproof concrete).

Specification	Wall thickness	PU	Ord. no.
Connection inside and outside possible.	240 - 290 mm	1	112 113
Contact plate ø 80 mm stainless steel V4A with 3 mounting holes ø 4 mm.	290 - 340 mm	1	112 114
M12 connection thread, M12 threaded rod (use optional screw-set 03).	340 - 390 mm	1	112 115
	390 - 440 mm	1	112 116
	440 - 490 mm	1	112 117
	490 - 540 mm	1	112 118
	540 - 590 mm	1	112 119
Cut to individual lengths	200 - 620 mm	1	112 130

Specification	Wall thickness	PU	Ord. no.
NEW! Equal to ord. no. 112 113, but with foam cover (use optional screw-set 03).	240 - 290 mm	1	112 313
	290 - 340 mm	1	112 314
	340 - 390 mm	1	112 315
	390 - 440 mm	1	112 316
	440 - 490 mm	1	112 317
	490 - 540 mm	1	112 318
	540 - 590 mm	1	112 319
Cut to individual lengths	200 - 620 mm	1	112 330

Specification	Wall thickness	PU	Ord. no.
NEW! Equal to ord. no. 112 113, but with foam cover, M12 connection thread, M16 threaded rod (use optional screw-set 03).	240 - 290 mm	1	112 160
	290 - 340 mm	1	112 161
	340 - 390 mm	1	112 162
	390 - 440 mm	1	112 163
	440 - 490 mm	1	112 164
	490 - 540 mm	1	112 165
	540 - 590 mm	1	112 166
Cut to individual lengths	200 - 620 mm	1	112 167

Specification	Wall thickness	PU	Ord. no.
NEW! Equal to ord. no. 112 113, but with foam cover, M16 connection thread, M16 threaded rod (use optional screw-set 06).	240 - 290 mm	1	112 170
	290 - 340 mm	1	112 171
	340 - 390 mm	1	112 172
	390 - 440 mm	1	112 173
	440 - 490 mm	1	112 174
	490 - 540 mm	1	112 175
	540 - 590 mm	1	112 176
Cut to individual lengths	200 - 620 mm	1	112 177

Note:

The value for I_k = short circuit current (50Hz)(1s; ≤ 300°C) can be found in the index directory starting from page 184.

Wall bushing



Wall bushing with water barrier

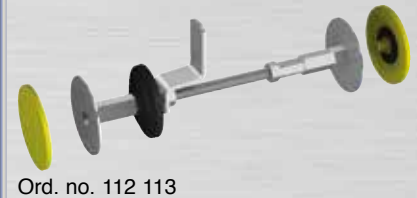



Fixed earthing terminal wall bushing



Ord. no. 112 009

Fixed earthing terminal with water barrier



Ord. no. 112 100



Ord. no. 112 300



Ord. no. 112 140

Water barrier, for bushings

NEW!



Ord. no. 112 040

Ord. no. 112 042

Wall bushing with fixed length





Ord. no. 112 180

Fixed earthing terminal, for the connection of earth termination systems to reinforcement and down conductors. **Lengths or wall thickness must be specified on ordering.**

Specification	Screw-sets (page 108) optional		Ord. no.
	connection thread	set-no.	
Interior and exterior connection possible Contact plate ø 80 mm stainless steel V4A with 3 mounting holes ø 4 mm on each plate; connection thread M10, threaded rod M10 up to max. 400 mm (additional lengths on request)	M10	set 01	112 009 
Equal to ord. no. 112 009,	M12	set 03	112 003
NEW! Equal to ord. no. 112 009, but with foam cover	M10	set 01	112 209
NEW! Equal to ord. no. 112 003, but with foam cover	M12	set 03	112 203

Fixed earthing terminal with water barrier, for waterproof concrete, for the connection of earth termination systems, lightning protection and bonding bars.

Specification	Screw-sets (page 108) optional		Ord. no.
	connection thread	set-no.	
Contact plate ø 80 mm stainless steel V4A with 3 mounting holes ø 4 mm with terminal stud ø 10 mm, total length 190 mm	M12	set 03	112 100 
	M10	set 02	
NEW! Equal to ord. no. 112 100, but with foam cover	M12	set 03	112 300
	M10	set 02	
NEW! Contact plate ø 50 mm stainless steel V4A Red plastic ring, ø 95 mm with 3 mounting holes ø 3,4 mm; with clamping pin ø 10 mm, total length 200 mm	M10	set 01	112 140 
NEW! Equal to ord. no. 112 140,	M12	set 03	112 141
NEW! Equal to ord. no. 112 140, but with foam material	M10	set 01	112 340
NEW! Equal to ord. no. 112 140, but with foam material	M12	set 03	112 341

Water barrier for bushings, for watertight base plates or walls. Designed to be pushed onto conductors.

Specification	Fit	PU	Ord. no.
Rubber (TPE-free)	ø 8 mm	1	112 040
Rubber (TPE-free)	ø 10 mm	1	112 041
Rubber (TPE-free)	flat 30 x 3.5 mm	1	112 042

Wall bushing with fixed length and water barrier, for the water pressure-tight connection of earthing and equipotential bonding conductors.

Specification	Wall thickness	PU	Ord. no.
NEW! Contact plate ø 80 mm stainless steel V4A with 3 mounting holes ø 4 mm Connecting thread M12 (use optional screw set 03) Connecting bolts ø 25 mm	up to 100 mm	1	112 180 
	101-150 mm	1	112 181
	151-200 mm	1	112 182
	201-250 mm	1	112 183

Lengths or wall thickness must be specified on ordering.

Note:

The value for I_k = short circuit current (50Hz)(1s; ≤ 300°C) can be found in the index directory starting from page 184.



Wall bushing for metal facade elements

NEW!

Benefits:

- Lightning current carrying capability tested according to EN 62561-1 class H 100 kA (10/350 μ s).
- Both-sided sealing of drill hole with integrated neoprene sealing rings.
- Economical and practical solution.

Wall bushing for lightning current carrying connection of metal facade elements.

Specification

Element thickness	PU	Ord. no.
up to 160 mm	1	112 027

NEW!

Stainless steel V2A
 Threaded bar M10
 Two contact plates 70 x 40 mm
 with 4 rivet bores \varnothing 5.1 mm
 and attached neoprene sealing ring.
 Other element thicknesses on request.



Wall bushing

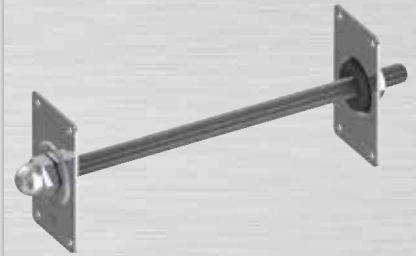

Ord. no. 112 027

Example of application

Steel construction used as a natural component of LPS

Metal facade elements used as natural component of LPS





Parallel and cross terminal clamp



Ord. no. 111 400

Cross clamp



Ord. no. 112 005

Screw SET



Ord. no. 112 049

Connection angle



Ord. no. 112 053

Ord. no. 112 018

Extension piece for fixed earthing terminals



Ord. no. 112 043

Accessories for fixed earthing terminals and wall bushings

Parallel and cross terminal clamp for connecting fixed earthing terminals.

Specification	Fit	PU	Ord. no.
Steel, hot galvanized	ø 8-10 mm and flat 30 mm ø 10-25 mm	25	111 400
Benefits: Because of two threaded bolts M10x60 mm in the central plate two installation steps are possible: <ol style="list-style-type: none"> 1. Connect the foundation earth electrode to the reinforcement and 2. Connect and secure the fixed earthing terminal to the earth conductor - parallel and cross possible! 			

Cross clamp, with welded threaded bolt and 4 screws M8 x 25 mm

Specification	PU	Ord. no.
Cross clamp (60 x 60 mm) steel, hot galvanized for flat 30 mm / ø 8-10 mm; threaded bolt M12 x 25 mm	1	112 005
Cross clamp (60 x 60 mm) stainless steel V4A for flat 30 mm / ø 8-10 mm; threaded bolt M12 x 25 mm	1	112 039
NEW! Cross clamp (70 x 70 mm) stainless steel V4A for flat 40 mm / ø 8-10 mm; threaded bolt M16 x 40 mm	1	112 045

Screw set, consisting of a hexagonal screw DIN 933 and a tension washer DIN 6796. Completely made of **stainless steel V4A**

Set	Specification	PU	Ord. no.
01	Hexagonal screw M10 x 25	1	112 047
02	Hexagonal screw M10 x 40	1	112 049
03	Hexagonal screw M12 x 25	1	112 048
04	Hexagonal screw M12 x 60	1	112 050
05	Hexagonal screw M16 x 25	1	112 051
06	Hexagonal screw M16 x 30	1	112 052

Note: See details for the fixed earthing terminals /wall bushings.

Connection angle, for fixed earthing terminals. Completely made of **stainless steel V4A**

Specification	Bore hole	Height	PU	Ord. no.
Stainless steel V4A 30 x 3.5 mm	10.5 mm	28 mm	1	112 017
Stainless steel V4A 30 x 3.5 mm	10.5 mm	43 mm	1	112 053
Stainless steel V4A 30 x 3.5 mm	12.5 mm	28 mm	1	112 018
Stainless steel V4A 30 x 3.5 mm	12.5 mm	43 mm	1	112 054
NEW! Stainless steel V4A 40 x 5.0 mm	16.5 mm	40 mm	1	112 046

Extension piece for fixed earthing terminals on walls with insulation coating

Specification	Isolierstärke	PU	Ord. no.
Extension piece M12 / M12 incl. spring ring, completely made of stainless steel V4A (optional use of screw set 03)	bis 100 mm	1	112 043
	bis 150 mm	1	112 044

Other disconnection clamps with terminal angle to be found on page 75.



Earthing kit, DB (German railways) approved

Earthing kit, for connecting reinforcements.

Approval: Eisenbahn Bundesamt (German railways); number of drawing 3 Ebs 15.03.19 Bl. 13

Specification	Cross section	Total length	PU	Ord. no.
Version I for short circuit currents ≤ 25 kA Fixed earthing terminal \varnothing 50 mm made of Cu - alloy; with inner thread M 16	70 mm ²	500 mm	1	113 085
	70 mm ²	1000 mm	1	113 088
Version II for short circuit currents > 25 kA Fixed earthing terminal \varnothing 50 mm made of Cu - alloy; with inner thread M 16	95 mm ²	500 mm	1	113 105
	95 mm ²	1000 mm	1	113 108

JP-EG - Version I



Ord. no. 113 085

Earthing kit, angled earthing kit, for connecting reinforcements

Approval: Eisenbahn Bundesamt (German railways); number of drawing 3 Ebs 15.03.19 Bl. 13

Specification	Cross section	Total length	PU	Ord. no.
Version I for short circuit currents ≤ 25 kA Fixed earthing terminal \varnothing 50 mm made of Cu - alloy; with inner thread M 16	70 mm ²	500 mm	1	113 260
	70 mm ²	1000 mm	1	113 270
Version II for short circuit currents > 25 kA Fixed earthing terminal \varnothing 50 mm made of Cu - alloy; with inner thread M 16	95 mm ²	500 mm	1	113 290
	95 mm ²	1000 mm	1	113 300

JP-EG - Version II



Ord. no. 113 260

Earthing kit, for connecting reinforcements.

Approval: Eisenbahn Bundesamt (German railways); number of drawing 3 Ebs 15.03.19 Bl. 13

Specification	Cross section	Total length	PU	Ord. no.
Version I for short circuit currents ≤ 25 kA 2 terminal brackets steel, bare 40 x 5,0 mm	70 mm ²	500 mm	1	113 123
	70 mm ²	1000 mm	1	113 125
Version II for short circuit currents > 25 kA 2 terminal brackets steel, bare 40 x 5,0 mm	95 mm ²	500 mm	1	113 133
	95 mm ²	1000 mm	1	113 135

JP-EGL - Version I



Ord. no. 113 123

Earthing kit, crimped with terminal brackets

Approval: Eisenbahn Bundesamt (German railways); number of drawing 3 Ebs 15.03.19 Bl. 22

Specification	Cross section	Total length	PU	Ord. no.
Version I for short circuit currents ≤ 25 kA 2 terminal brackets steel (coppered)	70 mm ²	500 mm	1	114 400
	70 mm ²	1000 mm	1	114 500
Version II for short circuit currents > 25 kA 2 terminal brackets steel (coppered)	95 mm ²	500 mm	1	114 550
	95 mm ²	1000 mm	1	114 650

JP-EGLVP



Ord. no. 114 400

Earthing kit, crimped

Approval: Eisenbahn Bundesamt (German railways); number of drawing 3 Ebs 15.03.19 Bl. 22

Specification	Cross section	Total length	PU	Ord. no.
Version I for short circuit currents ≤ 25 kA Fixed earthing terminal \varnothing 50 mm made of Cu - alloy; with inner thread M 16	70 mm ²	500 mm	1	114 700
	70 mm ²	1000 mm	1	114 800
Version II for short circuit currents > 25 kA Fixed earthing terminal \varnothing 50 mm made of Cu - alloy; with inner thread M 16	95 mm ²	500 mm	1	114 850
	95 mm ²	1000 mm	1	114 950

JP-EGVP



Ord. no. 114 700

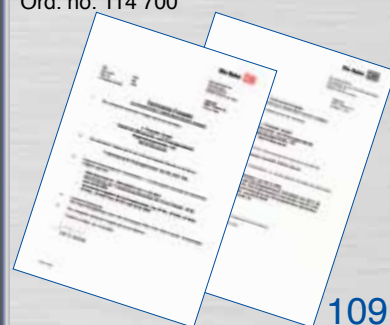



Earthing terminal JP-EAG (straight)



Ord. no. 113 216

Earthing connector JP-EV



Ord. no. 113 029

Earthing cable lug open or closed



Ord. no.
T 14 A 0001 A

Ord. no.
T 14 B 0001 A

Ord. no.
T 14 B 0002 A

Earthing conductor

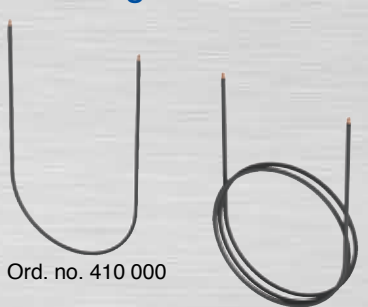

Ord. no. 410 000

Ord. no. 416 000

Earthing terminal, , with weld-on lug for connecting to the reinforcement.

Approval: Eisenbahn Bundesamt (German railways); number of drawing 3 Ebs 15.03.19 Bl. 13

Specification	Total length	PU	Ord. no.
for short circuit currents > 25 kA	200 mm	1	113 216
fixed earthing terminal \varnothing 50 mm made of Cu - alloy ; with inner thread M 16, welded with terminal bracket steel, bare 40 x 5.0 mm	500 mm	1	113 219

Earthing connector, for the bridging connection of earthing terminals or earthing kits.

Approval: Eisenbahn Bundesamt; number of drawing 3 Ebs 15.03.01 and 4 Ebs 15.03.17

Specification	Total length	PU	Ord. no.
Version I for short circuit currents \leq 25 kA cross section 50 mm ² , with heat shrink tubing (on both sides) copper cable with plastic coating (NYY-0)	250 mm	1	113 029
Version II for short circuit currents > 25 kA cross section 70 mm ² , with shrink-on tube (on both sides) copper cable with plastic coating (NYY-0)	250 mm	1	113 030

Models available in all lengths.

Earthing material and earthing conductor

proven for over 30 years. (Operative range, e.g. German armed forces /technical containers)

Earthing cable lug brass/galSn for earthing conductors, frost-resistant up to -40°C.

Specification	Cross section	PU	Ord. no.
Cable lug open	6 - 16 mm ²	100	T 14 A 0001 A
Cable lug closed; \varnothing 8.5 mm	6 - 16 mm ²	100	T 14 B 0001 A
Cable lug closed; \varnothing 10.5 mm	6 - 16 mm ²	100	T 14 B 0002 A

Earthing conductor made of highly flexible copper, frost-resistant up to -40°C.

Specification	Cross section	PU	Ord. no.
Copper	10 mm ²	running metre	410 000
Copper	16 mm ²	running metre	416 000

Possible combinations.



Marker sleeves for the conductors on request.



Equipotential bonding



Equipotential bonding



Equipotential bonding bars

Benefits:

- Terminal screws with string lock washer against self-loosening.
- Connection possible from top or bottom.
- Captive screws are individually removeable if needed.
- Unbreakable aluminium cover, lead-sealable.
- Low profile installation.
- Bus bar numbering of the individual clamping points.
- Simple installation – only two screws needed for mounting.

Equipotential bonding bar with metal cover

(J.P. utility patent)



Ord. no. 111 075

NEW!

Equipotential bonding bar with aluminium cover, for equipotential bonding according to EN 62305-3 and IEC 60364-4-41/60364-5-54.

Specification	PU	Ord. no.
Suitable for the connection of:	1	111 075
1 x flat conductor up to 30 x 5.0 mm or \varnothing 8-10 mm		
1 x round conductor 25 - 95 mm ² (\varnothing 4-12 mm) single-core/stranded		
7 x conductor 2.5 - 25 mm ² (\varnothing 1-7,5 mm) single-core/stranded finely stranded (with ferrule)		

Connection piece to extend the equipotential bonding bar (111 075)

Specification	PU	Ord. no.
Copper, gal Sn	1	111 076

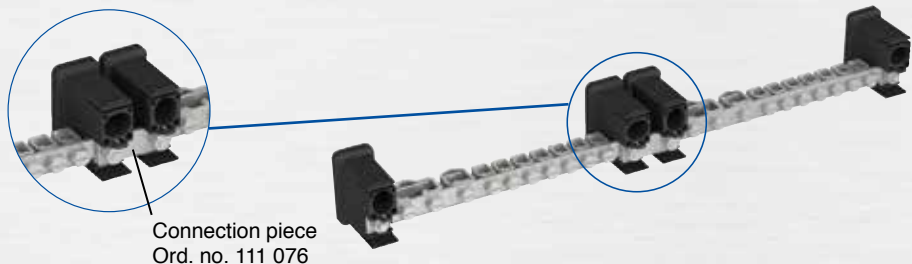

Connection piece
Ord. no. 111 076

Equipotential bonding bar

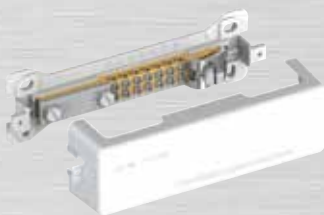

Ord. no. 111 070

Test joint box with equipotential bonding bar

NEW!



Ord. no. 111 590

Equipotential bonding bar with plastic cover, for equipotential bonding according to IEC 60364-4-41/60364-5-54.

Specification	PU	Ord. no.
Suitable for the connection of:	1	111 070
1 x flat conductor up to 30 x 5 mm or \varnothing 8-10 mm		
1 x round conductor \varnothing 8-12 mm		
7 x conductor up to 25 mm ² single-core/stranded or 16 mm ² finely stranded		

Test joint box with equipotential bonding bar for external thermal insulation composite systems

Specification	Installation depth	PU	Ord. no.
Dimensions of box: (196 x 158 mm)	90 - 140 mm	1	111 590
Bonding bar with terminals for			
- 1 x conductor fl. up to 30x5 mm or \varnothing 8-10 mm			
- 1 x conductor \varnothing 8-12 mm			
- 7 x conductor up to 25 mm ² (single-core/stranded) or 16 mm ² (finely stranded)			
Material contact bar: brass including V2A cover (220 x 180 mm) with affixed seal.			
Plastic material is self-extinguishing and halogen-free. V2A cover confirms to degree of protection IP65.			

Cover with company logo on request. Price on application.

Bonding bar, for equipotential bonding according to IEC 60364-4-41/60364-5-54 and for lightning equipotential bonding according to EN 62305, complete with screw M10x25 mm, nuts, spring lock washers and insulators. Delivery incl. fastening screws.

Specification	Specification screws	Number of terminals	Dimensions	PU	Ord. no.
			Length / width x thickness		
Copper	V2A	5	220 / 40 x 5 mm	1	910 009
Copper	V2A	6	250 / 40 x 5 mm	1	2072
Copper	V2A	8	310 / 40 x 5 mm	1	910 375
Copper	V2A	10	370 / 40 x 5 mm	1	910 139
Copper	V2A	12	430 / 40 x 5 mm	1	910 193
Copper	V2A	14	490 / 40 x 5 mm	1	910 010
Copper	V2A	15	520 / 40 x 5 mm	1	910 359
Copper	V2A	16	550 / 40 x 5 mm	1	910 527
Copper	V2A	18	640 / 40 x 5 mm	1	910 540
Copper	V2A	20	700 / 40 x 5 mm	1	910 382
Stainless steel V2A	V2A	5	220 / 40 x 5 mm	1	910 011
Stainless steel V2A	V2A	6	250 / 40 x 5 mm	1	112 082
Stainless steel V2A	V2A	8	310 / 40 x 5 mm	1	910 385
Stainless steel V2A	V2A	10	370 / 40 x 5 mm	1	910 302
Stainless steel V2A	V2A	12	430 / 40 x 5 mm	1	910 012
Stainless steel V2A	V2A	14	490 / 40 x 5 mm	1	910 013
Stainless steel V2A	V2A	15	520 / 40 x 5 mm	1	910 018
Stainless steel V2A	V2A	16	550 / 40 x 5 mm	1	910 019
Stainless steel V2A	V2A	18	640 / 40 x 5 mm	1	910 020
Stainless steel V2A	V2A	20	700 / 40 x 5 mm	1	910 022

NEW! Secured with carriage bolt against rotation!

Cover with fastening screws **stainless steel V2A**.

Specification	Number of terminals	Length	PU	Ord. no.
Stainless steel V2A	5	220 mm	1	9105
Stainless steel V2A	6	250 mm	1	9106
Stainless steel V2A	8	310 mm	1	9108
Stainless steel V2A	10	370 mm	1	9110
Stainless steel V2A	12	430 mm	1	9112
Stainless steel V2A	14	490 mm	1	9114
Stainless steel V2A	15	520 mm	1	9115
Stainless steel V2A	16	550 mm	1	9116
Stainless steel V2A	18	640 mm	1	9118
Stainless steel V2A	20	700 mm	1	9120
NEW! Aluminium	5	220 mm	1	111 090
Aluminium	6	250 mm	1	111 091
Aluminium	8	310 mm	1	111 092
Aluminium	10	370 mm	1	111 093
Aluminium	12	430 mm	1	111 094
Aluminium	14	490 mm	1	111 095
Aluminium	15	520 mm	1	111 096
Aluminium	16	550 mm	1	111 097
Aluminium	18	640 mm	1	111 098
NEW! Aluminium	20	700 mm	1	111 099

Multi-Mini saddle clamp for equipotential bonding.
Conductor connection lengthwise or crosswise. Clamping range up to 8 mm.

Specification	Fit	PU	Ord. no.
Stainless steel V2A	6 mm ² (ø 2.8 mm) - 50 mm ² (ø 8 mm)	100	111 780
Stainless steel V2A/coppered	6 mm ² (ø 2.8 mm) - 50 mm ² (ø 8 mm)	100	111 781
Steel, hot galvanized	6 mm ² (ø 2.8 mm) - 50 mm ² (ø 8 mm)	100	111 782

Example of application:



Bonding bar flat



Ord. no. 2072



Ord. no. 112 082

Stainless steel cover



Ord. no. 9106

Example of application
Aluminium cover:

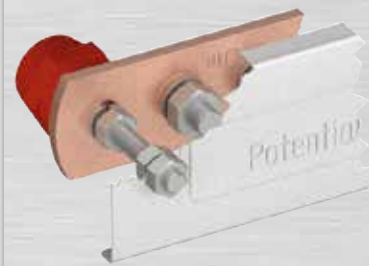

Multi-Mini saddle clamp



Ord. no. 111 780



Single row



Ord. no. 913 653

Single row with connection screws



Ord. no. 910 306

Double row



Ord. no. 913 662

Double row with connection screws



Ord. no. 910 380

Earthing busbar (angled)

Earthing busbar, wall distance (height ~ 35 mm); connecting bores \varnothing 10,5 mm.

Specification	Number of terminals	Dimensions	PU	Ord. no.
		Length / width x thickness		
Stainless steel V2A	2	135 / 30 x 3.5 mm	1	913 650
Stainless steel V2A	3	165 / 30 x 3.5 mm	1	913 651
Stainless steel V2A	4	195 / 30 x 3.5 mm	1	913 652
Stainless steel V2A	5	225 / 30 x 3.5 mm	1	913 653
Stainless steel V2A	6	255 / 30 x 3.5 mm	1	913 654
Stainless steel V2A	7	285 / 30 x 3.5 mm	1	913 655
Stainless steel V2A	8	315 / 30 x 3.5 mm	1	913 656
Stainless steel V2A	9	345 / 30 x 3.5 mm	1	913 657
Stainless steel V2A	10	375 / 30 x 3.5 mm	1	913 658

Earthing busbar, wall distance (height ~ 35 mm),
Including screws M10x25 mm, nuts, spring lock washers

Specification	Specification screw	Number of terminals	Dimensions	PU	Ord. no.
			Length / width x thickness		
Stainless steel V2A	V2A	2	135 / 30 x 3.5 mm	1	910 330
Stainless steel V2A	V2A	3	165 / 30 x 3.5 mm	1	910 331
Stainless steel V2A	V2A	4	195 / 30 x 3.5 mm	1	910 305
Stainless steel V2A	V2A	5	225 / 30 x 3.5 mm	1	910 306
Stainless steel V2A	V2A	6	255 / 30 x 3.5 mm	1	910 307
Stainless steel V2A	V2A	7	285 / 30 x 3.5 mm	1	910 332
Stainless steel V2A	V2A	8	315 / 30 x 3.5 mm	1	910 308
Stainless steel V2A	V2A	9	345 / 30 x 3.5 mm	1	910 333
Stainless steel V2A	V2A	10	375 / 30 x 3.5 mm	1	910 309

Earthing busbar, wall distance (height ~ 65 mm); connecting bores \varnothing 10,5 mm.

Specification	Number of terminals	Dimensions	PU	Ord. no.
		Length / width x thickness		
Steel, hot galvanized	2 x 2	225 / 60 x 5 mm	1	913 666
Steel, hot galvanized	2 x 4	305 / 60 x 5 mm	1	913 667
Steel, hot galvanized	2 x 6	385 / 60 x 5 mm	1	913 668
Stainless steel V2A	2 x 2	225 / 60 x 5 mm	1	913 660
Stainless steel V2A	2 x 4	305 / 60 x 5 mm	1	913 661
Stainless steel V2A	2 x 6	385 / 60 x 5 mm	1	913 662

Earthing busbar, wall distance (height ~ 65 mm),
Including screws M10x25 mm, nuts, spring lock washers

Specification	Specification screw	Number of terminals	Dimensions	PU	Ord. no.
			Length / width x thickness		
Steel, hot galvanized	V2A	2 x 2	225 / 60 x 5 mm	1	910 223
Steel, hot galvanized	V2A	2 x 4	305 / 60 x 5 mm	1	910 023
Steel, hot galvanized	V2A	2 x 6	385 / 60 x 5 mm	1	910 301
Stainless steel V2A	V2A	2 x 2	225 / 60 x 5 mm	1	910 544
Stainless steel V2A	V2A	2 x 4	305 / 60 x 5 mm	1	910 545
Stainless steel V2A	V2A	2 x 6	385 / 60 x 5 mm	1	910 380

Additional dimensions, hole spacings, hole diameters or types of connection (e.g. KS-connector or Vario-clamp for flat strips) available on request.



Accessories

Straightening tools for round wires and strips, screws and earth testers



Accessories



Straightening tool



Ord. no. 111 080

Straightening tool



Ord. no. 111 081

Universal straightening tool

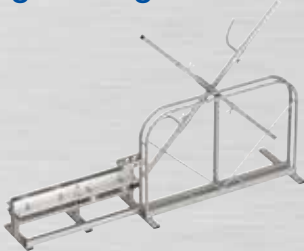

Ord. no. 111 082

Straightening tool for strips



Ord. no. 111 083

Uncoiling unit



Ord. no. 111 084

Straightening tool for round wires and strips

Straightening tool, without reel-off unit.

two-part for wire \varnothing 8-10 mm.

Specification	PU	Ord. no.
Technical data: Weight: 15 kg Consists of 8 Aluminium brackets 60 x 60 x 5 x 350 mm and 6 levelling rolls - hardened steel with bronze bushing sleeve. Wire straightening at 4 levels. Levelling rolls can be adjusted to different degrees of hardness at 4 levels.	1	111 080

Straightening tool, with horizontal reel-off unit.

two-part for wire \varnothing 8-10 mm.

Specification	PU	Ord. no.
Technical data: Weight: 25 kg Straightening device (as described above) Horizontal reel-off unit, adjustable to different coil diameters. Demountable, space saving design.	1	111 081

Universal straightening tool, with vertical reel-off unit.

To be used for round wire \varnothing 8 - 10 mm and strips 30 x 3.5 mm.

Specification	PU	Ord. no.
Technical data: Weight: 47 kg Straightening device (as described above) Vertical reel-off unit, adjustable to different coil diameters. Uncoiling unit is also suitable for strips 30 x 3.5 mm.	1	111 082

Straightening tool for strips with 5 levelling rolls, for strips 30 x 3.5 mm.

Specification	PU	Ord. no.
Technical data: Weight: 23 kg Length: 1390 mm, width*: 120 mm, height: 670 mm. (* base can be swivelled in) Uncoil, straighten and install in one step. Very easy handling Time saving installation of strips	1	111 083

Uncoiling unit for strips 30 x 3.5 mm.

Specification	PU	Ord. no.
Technical data: Weight: 13 kg Length: 1060 mm, width*: 120 mm, height: 670 mm. (* base can be swivelled in) Uncoil, straighten and install in one step. Very easy handling Any extra uncoiled strip can be rolled up again.	1	111 084



Straightening tool for round wires and strips

Manual straightening and bending tool - light version

manual tool for round wires.

Specification	Weight	Fit	PU	Ord. no.
Made of forged steel - chromium-plated surface, hardened straightening bolts. Optimal straightening geometry for fast straightening and bending of round wires.	280 g	ø 8-10 mm wrench width 13 and 17	1	110 247

Manual straightening and bending tool - heavy-duty type

manual tool for wire and strip straightening.

Specification	Weight	Fit	PU	Ord. no.
Consisting of a stainless steel V2A tube, PVC handle and a swiveling straightening head made of hardened steel, with 3 attached straightening bolts and a alignment slot. The 9 steps adjustable straightening head can be optimally fitted to the respective work situation.	1200 g	ø 10 mm flat 30	1	110 244



Niro-Clip conductor fastener opening tool - for unclipping round wire ø 8 mm from Niro-Clip and roof conductor holder of J. Pröpster GmbH.

Specification	Weight	Fit	PU	Ord. no.
Niro-Clip opening tool made of polyamide with bi-hexagon wrench width 13/17	54 g	ø 8 mm	1	110 230

Manual straightening and bending tool - to unclip round wires from Niro-Clip.

Specification	Weight	Fit	PU	Ord. no.
Steel, hot galvanized	500 g	ø 8 mm	1	1049

Manual straightening tool - for round wires.

Specification	Weight	Fit	PU	Ord. no.
as tube with levelling studs	330 g	ø 8-10 mm	1	110 245

Manual straightening tool - for strips.

Specification	Weight	Fit	PU	Ord. no.
as tube with levelling studs and bending slots	600 g	ø 8-10/30 mm	1	110 246

Manual straightening tool - light version

NEW!



Ord. no. 110 247

Manual straightening tool - heavy-duty type

NEW!



Ord. no. 110 244

Niro-Clip opener

NEW!



Ord. no. 110 230

Manual straightening and bending tool

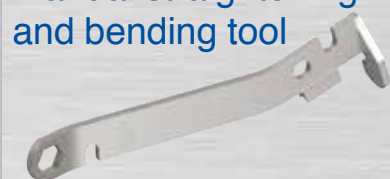

Ord. no. 1049

Manual straightening tool - for round wires



Ord. no. 110 245

Manual straightening tool - for strips

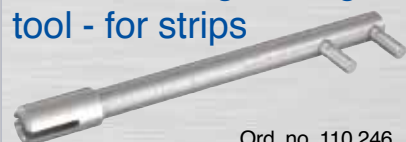

Ord. no. 110 246



Corrosion prevention tape



Ord. no. 1024

Heat shrink tubing



Ord. no. 102 209

Prönit



Ord. no. 111 446

Screws and accessories



similar to DIN 84

DIN 933

DIN 934

DIN 127

DIN 7504

DIN 7981

DIN 7996

Shoulder screw

DIN 7337

Plastic dowel

Corrosion prevention tape

for corrosion protection of conductor connections in the soil.

Specification	Width	PU	Ord. no.
Corrosion prevention tape as 10 m long rolls	50 mm	1	1024
	100 mm	1	1025
Corrosion prevention tape with single-sided laminated PE protective foil as 10 m long rolls	50 mm	1	1068
	100 mm	1	1069

No need to wear safety gloves

Heat shrink tubing, for corrosion protection of connectors, strips and rods.

Specification	Fit	PU	Ord. no.
Heat shrink tubing (black)	ø 9-16 mm	50 m	102 208
	fl. 30 mm	50 m	102 209

Prönit -

Special concrete with high swellability to be used as a compound to improve the earth resistance.

Specification	PU	Ord. no.
Powder in sacks	25 kg	111 446

Screws and accessories

Specification	Material	Dimensions	PU
Cylinder head screw slotted and cross recessed (similar to DIN 84)	Stainless steel V2A	M6x12 mm	100
	Stainless steel V2A	M6x20 mm	100
	Stainless steel V2A / coppered	M6x12 mm	100
	Stainless steel V2A / coppered	M6x20 mm	100
DIN 933 Hexagon bolt	Stainless steel V2A	M8x25 mm	100
	Stainless steel V2A	M10x25 mm	100
	Stainless steel V2A / coppered	M8x25 mm	100
	Stainless steel V2A / coppered	M10x25 mm	100
DIN 934 Hexagon nut	Stainless steel V2A	M6	100
	Stainless steel V2A	M8	100
	Stainless steel V2A	M10	100
	Stainless steel V2A / coppered	M6	100
	Stainless steel V2A / coppered	M8	100
	Stainless steel V2A / coppered	M10	100
DIN 7504 Drilling screw WS10	Stainless steel V2A-hexagon	6.3x19 mm	100
DIN 7981 Sheet-metal screw	Stainless steel V2A-cross recess	6.3x19 mm	100
DIN 127 B Spring lock washer	Stainless steel V2A	B8	100
	Stainless steel V2A	B10	100
DIN 7996 Halfround-wood screw - cross recessed	Stainless steel V2A	5x60 mm	100
	Stainless steel V2A	5x70 mm	100
Spax-screw with countersunk head cross recessed	Stainless steel V2A	5x60 mm	100
	Stainless steel V2A	5x70 mm	100
Shoulder screw	Steel electrogalvanized	M6 x 50 mm	100
	Steel electrogalvanized	M8 x 50 mm	100
Plastic dowel	Nylon	8x40 mm	500
	Nylon	10x50 mm	500
Plastic dowel with wood screw		8x120 mm	50
Blind rivet DIN 7337	Stainless steel V2A	5x12 mm	500
	Stainless steel V2A/Aluminium	5x12 mm	500

Heavy-duty anchor bolts on page 134. Additional dimensions on request



Mounting aid for connecting clamps (e.g. 111 330 on page 99)

NEW!

Mounting aid for connecting clamps (e.g. 111 330) -
for simple mounting, also in difficult to access reinforcement cages

Specification	Weight	Length	PU	Ord. no.
Consisting of a magnetic socket wrench width 17. Power-transmitting parts made of stainless steel V2A . Hexagon wrench width 10 used as drive; can be used in a drill if necessary.	210 g	40 mm	1	110 241
Equal to ord. no. 110 241, but with free-running handle	550 g	400 mm	1	110 242
	900 g	800 mm	1	110 243

Note: connecting clamps on page 99.

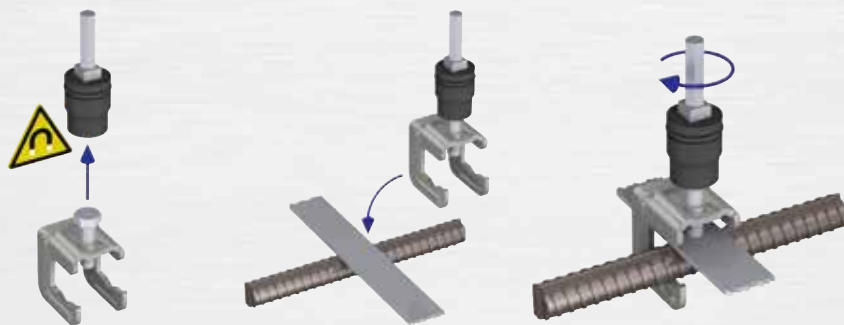

Place magnetic side of the socket wrench on the hexagon bolt of the connecting clamp.

Positioning of the clamp.

Tighten the positioned clamp until the required torque is reached (cordless screwdriver could be used).

Mounting aid

NEW!



Ord. no. 110 241

Ord. no. 110 242



Earth and soil resistivity tester



Ord. no. 2062



Ord. no. 2083

Accessory set for earth and soil resistivity tester



Ord. no. 2063

Clamp-on ground resistance tester



Ord. no. 2084

Continuity tester/insulation tester

NEW!



Ord. no. 2084

Earth tester

Tester for measuring earth and soil resistivity with digital-display (LCD).

Specification	PU	Ord. no.
C.A 6460 - earth and soil resistivity tester	1	2062
Range: 0,00 ... /2000 Ω within three ranges automatic range change		
Measurement frequency: 128 Hz		
Case: 273 x 247 x 127 mm, IP 53		
Weight: ~ 2.8 kg		
C.A 6462 - earth and soil resistivity tester	1	2062 S
Equal to C.A 6460 with an internal charger		
Weight: ~ 3.3 kg		
C.A 6423 - earth tester	1	2083
Range: 0,00 ... /2000 Ω automatic range change		
Measurement frequency: 128 Hz		
Case: 238 x 136 x 150 mm, IP 54		
Weight: ~ 1.3 kg		

Earth tester case

Specification	PU	Ord. no.
Earth tester case including 2 earth spikes (T-shaped)	1	2063
Cable: flat spool: green 10 m; wire coils: blue 1 x 150 m, red 1 x 150 m,		
1 set of connection clamps and hammer in carrying bag		

Clamp-on ground resistance tester

measuring instrument to review ground loops, with digital-display (OLCD).

Specification	PU	Ord. no.
C.A 6416 - clamp-on ground resistance tester	1	2081
Range: Loop impedance measurement: 0,01 - 1500 Ω Loop inductivity measurement: 10 - 500 μH Current measurement: 0,2 mA - 40 A		
Measurement frequency: 2083 Hz		
Data storage: 300 measurements with time stamp.		
Case: 262 x 95 x 55 mm		
Weight: ~ 1.0 kg		
C.A 6417 - clamp-on ground resistance tester	1	2084
Equal to C.A 6416 but with Bluetooth, Software GTC and data storage for 2000 measurements with time stamp		
Calibration loop for clamp-on ground resistance tester	1	2090

Continuity and insulation tester

e. g. for standardized continuity testing with a test current of 200 mA.

Specification	PU	Ord. no.
Metrix MX 407 - Insulation tester	1	2063 S
Test current for continuity testing: 200 mA according to EN 61557-4		
Continuity testing with buzzer.		
Insulation testing: 250 V / 500 V / 1000 V		
Voltage measurement: 0 - 600 V AC/DC		
Case: 200 x 92 x 50 mm		
Weight: ca. 700 g		



Air termination systems, insulated lightning protection, JP-MBF BS system

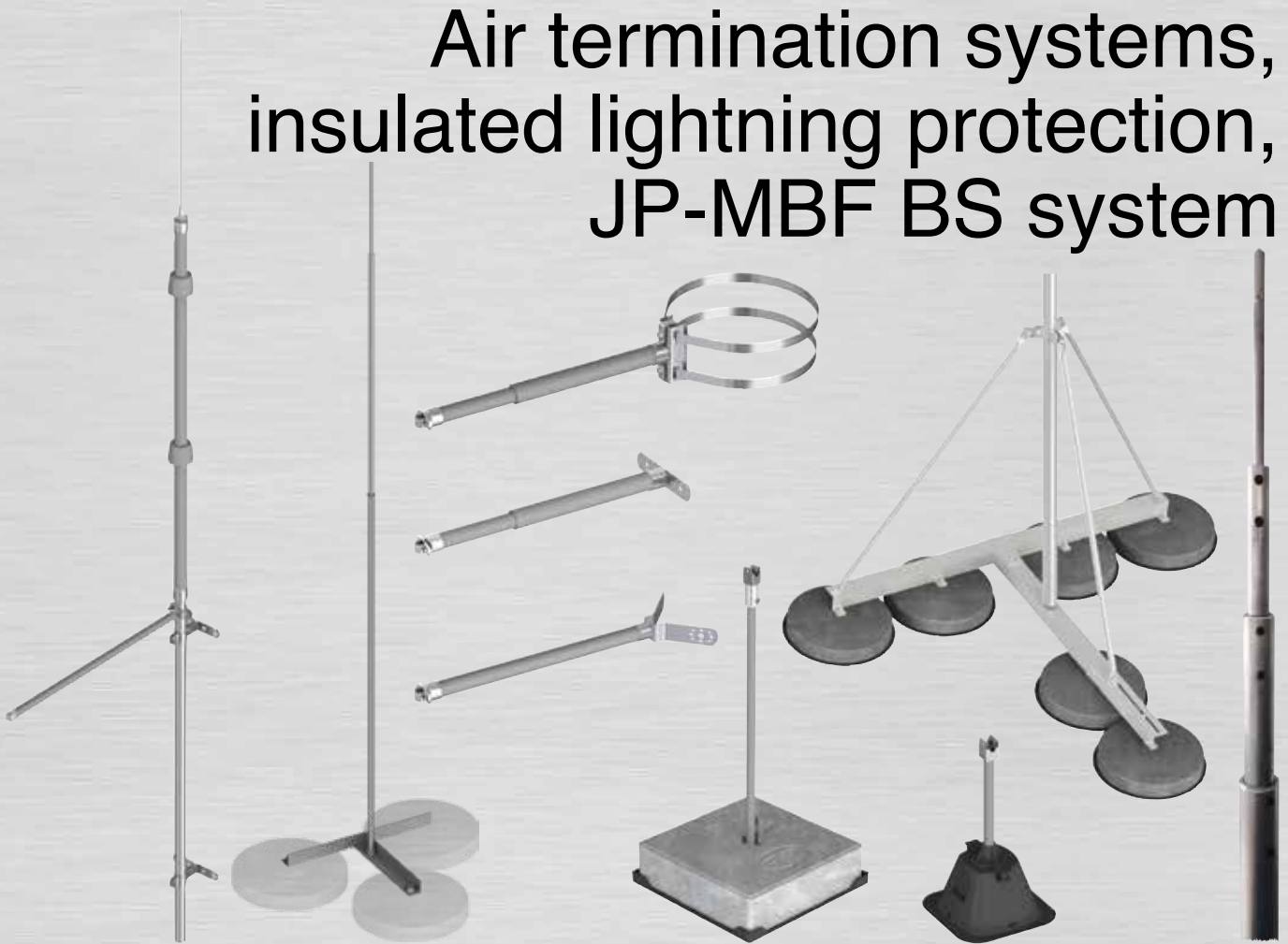

Please also ask for our special catalogue:





Ord. no. 111 496

Air termination pole base frame

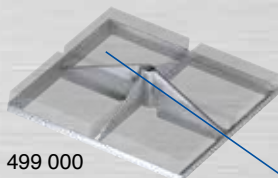

Ord. no. 499 000

Support plate



Ord. no. 499 010

Aldrey cable



Ord. no. 100 058

Interesting facts about insulated lightning protection systems

Generally, we differentiate between insulated and partially insulated lightning protection systems. Partially insulated systems are more common. To design such a system, the well-known mesh method is used to install an air termination system. The area with the roof installations is then equipped with additional insulated air termination rods.

A decisive advantage of insulated or partially insulated lightning protection systems consists in the fact that no partial lightning currents can penetrate into the building.

J.Pröpster offers an easy-to-assemble and well proved lightning protection system that guarantees maximum protection for your equipment.

Air termination pole for insulated air termination systems without lateral stand-off - to support long conductors.

Specification according to EN 62305-3 / EN 62561-2:

Air termination tip: Aluminium 0.75 m above air termination conductor
Insulated support: GRP 1.5 m
Stand pipe length: Stainless steel V2A variable (ø 42 mm)

Conductor height	Total height	Stand-offs	Mounting clamps	PU	Ord. no.
3.0 m	3.75 m	without	2	1	111 496
3.5 m	4.25 m	without	2	1	111 497

Additional lengths or combinations on request.

Air termination pole base frame with roof inclination adjustment up to 5°. For concrete bases 300 x 300 mm to position air termination poles ø 42 mm (e.g. 111 496).

Specification	Footprint	PU	Ord. no.
Stainless steel V2A	ca. 650 x 650 mm	1	499 000
NEW Support plate (one side aluminium-laminated)	ca. 650 x 650 mm	1	499 010
Roof inclination adjustment, inclination up to 10°		1	499 700



Roof inclination adjustment up to 5°



Roof inclination adjustment up to 10°
Ord. no. 499 700.

Air termination conductor, for free tension over the protected equipment

Specification	Fit	Weight/m	PU	Ord. no.
Aldrey cable	50 mm ²	~ 0.135 kg	rm	100 058



Insulated air termination pole

Air termination pole for insulated air termination systems
with lateral stand-off, to protect roof installations from direct lightning strikes.

Specification according to EN 62305-3 / EN 62561-2:

Air termination tip: Aluminium 0.75 m above air termination conductor
Insulated support: GRP 1.5 m
Stand pipe length: Stainless steel V2A variable (ø 42 mm)

Conductor height	Total height	Stand-offs	Mounting clamps	PU	Ord. no.
3.0 m	3.75 m	1	2	1	111 490
3.5 m	4.25 m	1	2	1	111 491
4.0 m	4.75 m	1	2	1	111 492
4.5 m	5.25 m	2	3	1	111 493
5.0 m, 2-parts	5.75 m	2	3	1	111 494
5.5 m, 2-parts	6.25 m	2	3	1	111 495



Air termination pole for insulated systems

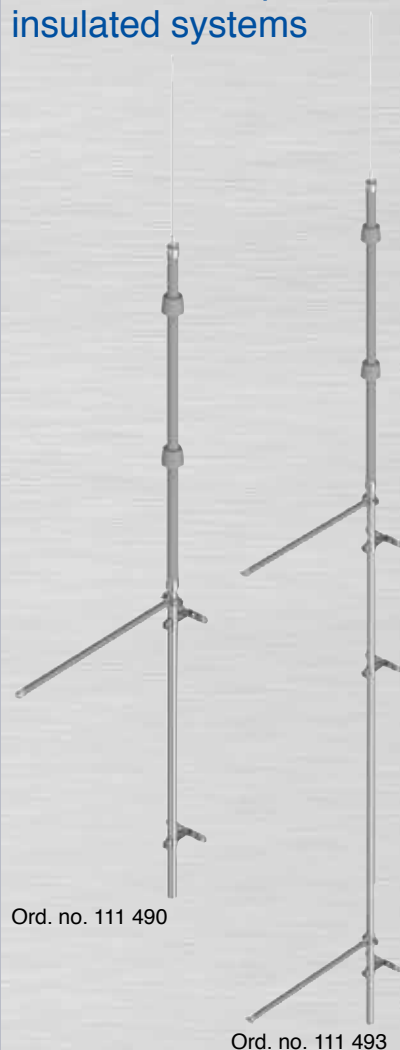

Ord. no. 111 490

Ord. no. 111 493

Insulated stand-off, with pipe clamp, height-adjustable on the stand pipe V2A ø 42 mm (air termination pole) with clamping component for aluminium conductor ø 8-10 mm.

Specification	PU	Ord. no.
0,5 m	1	490 405 V
0,8 m	1	490 408 V
1,0 m	1	490 410 V

Additional lengths on request!

Insulated stand-off with pipe clamp



Ord. no. 490 405 V

Air termination pole fastener for steel constructions (e.g. side rails) consisting of: Holder V2A on profile and pole holder V2A (cross clamp).

Specification	Profile	Fit in inch	Square profile	PU	Ord. no.
Round profile					
Stainless steel V2A	ø 26.9 mm	3/4"		1	490 490
Stainless steel V2A	ø 42.4 mm	1 1/4"		1	490 491
Stainless steel V2A	ø 48.5 mm	1 1/2"		1	490 492
Square profile					
Stainless steel V2A		suitable for	20 x 20 mm to 50 x 50 mm	1	490 495

Additional diameters and dimensions on request.

Air termination pole fastener



Ord. no. 490 491

Ord. no. 490 495



Insulated stand-off with mounting plate



Ord. no. 490 433 S



Ord. no. 490 430

Insulated stand-off with tape clamp



Ord. no. 490 443



Ord. no. 490 513

Insulated stand-off - heavy-duty type

- All stand-offs for air termination rods (Al) \varnothing 16 mm and down conductors \varnothing 8 mm
- Insulated stand-off for free carrying of aluminium air termination rods

Insulated stand-off with flat mounting plate (stainless steel V2A) for mounting on walls and metal sheets.

Specification	Length	PU	Ord. no.
Infinitely adjustable:			
Telescopic insulated stand-off GRP, \varnothing 32/40 mm for \varnothing 16 mm and \varnothing 8-10 mm	350 - 500 mm	1	490 433 S
	650 - 1000 mm	1	490 433
with fixed length:			
Insulated stand-off GRP, \varnothing 32 mm for \varnothing 16 mm and \varnothing 8-10 mm	0.5 m	1	490 430
	0.8 m	1	490 431
	1.0 m	1	490 432



Insulated stand-off with tape pipe clamp (stainless steel V2A).

Specification	Length	PU	Ord. no.
Infinitely adjustable:			
Telescopic insulated stand-off GRP, \varnothing 32/40 mm for \varnothing 16 mm and \varnothing 8-10 mm tape pipe clamp max. \varnothing 800 mm	350 - 500 mm	1	490 443
	650 - 1000 mm	1	490 444
with fixed length:			
Insulated stand-off GRP, \varnothing 32 mm for \varnothing 16 mm and \varnothing 8-10 mm tape pipe clamp max. \varnothing 800 mm	0.5 m	1	490 513
	0.8 m	1	490 514
	1.0 m	1	490 515





Insulated stand-off with mounting bracket for rotatable or adjustable fixing elements
The insulated stand-off is adjustable in all directions.

Specification	Length	PU	Ord. no.
Infinitely adjustable:			
Telescopic insulated stand-off GRP , ø 32/40 mm mounting bracket ø 12.5 mm, for ø 16 mm and ø 8-10 mm	350 - 500 mm	1	490 535
	650 - 1000 mm	1	490 536
with fixed length:			
Insulated stand-off GRP , ø 32 mm mounting bracket ø 12.5 mm, for ø 16 mm and ø 8-10 mm	0.5 m	1	490 530
	0.8 m	1	490 531
	1.0 m	1	490 532

Fixing element for insulated stand-off with bracket.

Specification	Clamping range	PU	Ord. no.
Fixing element stainless steel V2A with mounting plate including installation material for the insulated stand-offs (screw M12x20, spring washer and hexagonal nut)	-	1	490 505
Fixing element stainless steel V2A with two terminal clamps, heavy-duty type	max. 19 mm	1	490 506
	19 - 36 mm	1	490 507
	36 - 52 mm	1	490 508



Insulated stand-off with fixing bracket



Ord. no. 490 535



Ord. no. 490 530

Fixing element
(adjustable in all directions)



Ord. no. 490 505



Ord. no. 490 506

Insulated stand-off for mounting on corners and building edges.

Specification	Length	PU	Ord. no.
with fixed length:			
Insulated stand-off GRP ø 32 mm for ø 16 mm and ø 8-10 mm	0.5 m	1	490 450
	0.8 m	1	490 451
	1.0 m	1	490 452

Additional stand-off lengths on request!

Insulated stand-off for corner mounting



Ord. no. 490 450



Insulated stand-offs -
- light-weight design
Individual combinations!

16plus⁺

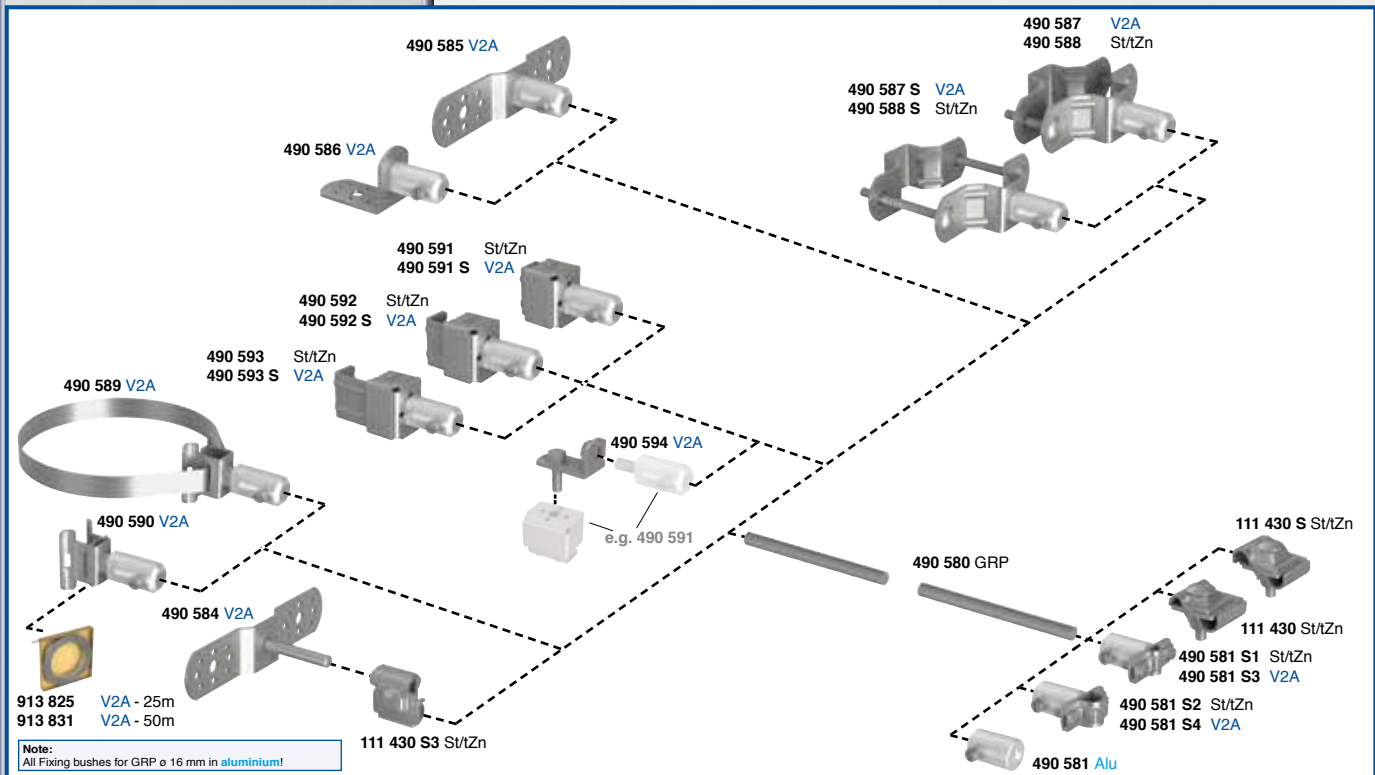

Note:
All Fixing bushes for GRP ø 16 mm in aluminium!

Fixing bush



Ord. no. 490 581 S2

Ord. no. 490 581 S1

Ord. no. 490 581

Multi-clamp

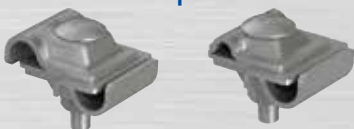

Ord. no. 111 430 S

Ord. no. 111 430

Solid rod GRP

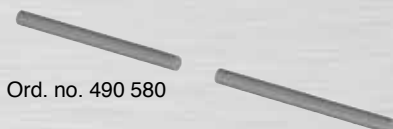

Ord. no. 490 580

Fixing side conductor or air termination rod:

Fixing bush with fastener for fixing air termination rods ø 16 mm and down conductors ø 8-10 mm to the solid rod GRP ø 16 mm.

Specification	Length	PU	Ord. no.
Fixing bush aluminium , for GRP ø 16 mm; for air termination rods ø 16 mm			
with fastener steel, hot galvanized, for ø 16 mm	40 mm	25	490 581 S2
with fastener stainless steel V2A , for ø 16 mm	40 mm	25	490 581 S4

Specification	Length	PU	Ord. no.
Fixing bush aluminium , for GRP ø 16 mm; for down conductors ø 8 - 10 mm			
with fastener steel, hot galvanized, for ø 8-10 mm	40 mm	25	490 581 S1
with fastener stainless steel V2A , for ø 8-10 mm	40 mm	25	490 581 S3
with inner thread M6	40 mm	25	490 581

Multi-clamp

Specification	Fit	PU	Ord. no.
Steel, hot galvanized	ø 16 / ø 16 mm	25	111 430 S
Steel, hot galvanized	ø 8-10 / ø 16 mm	50	111 430

Solid rod GRP:

to be cut to length.

Specification	Length	PU	Ord. no.
Solid rod GRP, ø 16 mm	3.0 m	10	490 580



Fixing side object:

Mounting plate and angle bracket for mounting on walls and metal sheets, with fixing bush **aluminium**, for GRP \varnothing 16 mm.

Specification	PU	Ord. no.
Mounting plate stainless steel V2A	25	490 585 
Angle bracket stainless steel V2A	25	490 586
Fixing bush aluminium , for GRP \varnothing 16 mm with hexagonal screw M10 x 16 stainless steel V2A	25	490 582

Mounting plate and angle bracket





Mounting plate with bolt for mounting on walls and metal sheets.

Specification	PU	Ord. no.
Mounting plate with bolt \varnothing 10 mm stainless steel V2A / 60 mm	25	490 584 
Multi-clamp steel, hot galvanized (\varnothing 10 / \varnothing 16 mm)	50	111 430 S3

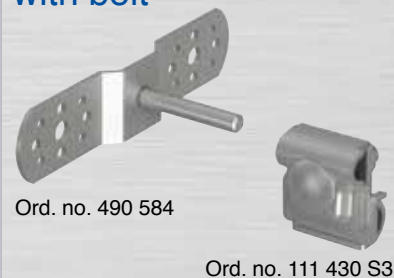
Mounting plate with bolt



Terminal clamp, heavy-duty type for mounting on steel constructions or railings, with fixing bush **aluminium**, for GRP \varnothing 16 mm.

Specification	Clamping range	PU	Ord. no.
Steel, hot galvanized	up to 19 mm	25	490 591
Steel, hot galvanized	19 - 36 mm	25	490 592
Steel, hot galvanized	36 - 52 mm	25	490 593
Stainless steel V2A	up to 19 mm	25	490 591 S 
Stainless steel V2A	19 - 36 mm	25	490 592 S
Stainless steel V2A	36 - 52 mm	25	490 593 S
Angle bracket stainless steel V2A , for terminal clamp, with hexagonal screw, nuts and spring lock washer		25	490 594 

Terminal clamp, heavy-duty type

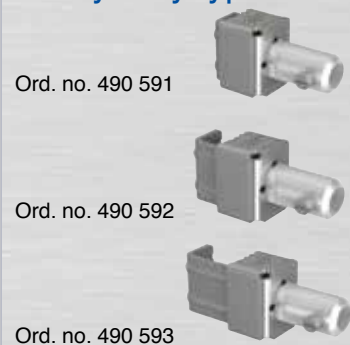

Pipe clamp for mounting on pipes or railings with fixing bush **aluminium**, for GRP \varnothing 16 mm.

Specification	Fit	Fit in inch	PU	Ord. no.
Pipe clamp stainless steel V2A with fixing screws in stainless steel V2A	\varnothing 42.4-60.3 mm	1 1/4" - 2"	20	490 587 
	\varnothing 42.4-88.9 mm	1 1/4" - 3"	20	490 587 S
Pipe clamp steel, hot galvanized with fixing screws in stainless steel V2A	\varnothing 42.4-60.3 mm	1 1/4" - 2"	20	490 588
	\varnothing 42.4-88.9 mm	1 1/4" - 3"	20	490 588 S

Pipe clamp



Pipe clamp for mounting on pipes up to \varnothing 300 mm with fixing bush **aluminium** for GRP \varnothing 16 mm.

Specification	Pipe- \varnothing	PU	Ord. no.
Pipe clamp with tensioning strap stainless steel V2A	max. \varnothing 300 mm	10	490 589 
Pipe clamp without tensioning strap stainless steel V2A	--	20	490 590
tensioning strap stainless steel V2A , 22 x 0.4 mm	--	25 m	913 825
	--	50 m	913 831

Tape pipe clamp



Note: For sheet metal chimneys, use an intermediate plate (e.g.: a piece of VA-sheet)



Insulated stand-off - light-weight types

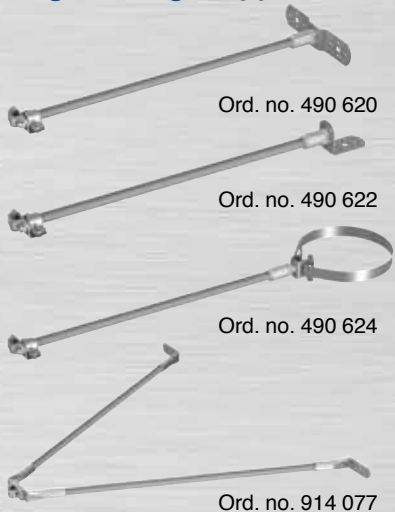

Ord. no. 490 620

Ord. no. 490 622

Ord. no. 490 624

Ord. no. 914 077

Insulated stand-off, light-weight type for the fixation of air termination rods with concrete base. Stand-off GRP \varnothing 16 mm for air termination rods **aluminium** \varnothing 16 mm.

Specification	Length	PU	Ord. no.
with mounting plate	0.50 m	1	490 620
	0.75 m	1	490 621
with angle bracket	0.50 m	1	490 622
	0.75 m	1	490 623
with tape pipe clamp up to \varnothing 300 mm	0.50 m	1	490 624
	0.75 m	1	490 625
V-shape with mounting lugs (Actual insulated distance 600 mm)	0.60 m	1	914 077

GRP-attic

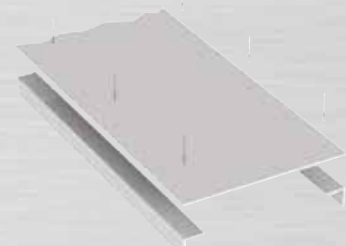

Ord. no. 490 701

JP-plastic attic made of GRP, for replacing metal attics with non-conducting material to control the separation distance.

Specification	Length	PU	Ord. no.
GRP-flat section (light grey) 450x3 mm	3.0 m	1	490 700
GRP-angle section (light grey) 60x40x3 mm	3.0 m	1	490 701

Note: flat and angle section are without bore holes and rivets (see page 118).

Accessories	PU	Ord. no.
Cleaning spray for GRP surfaces	1	490 702
Elastic universal adhesive and sealant	1	490 703

Bridging-SET

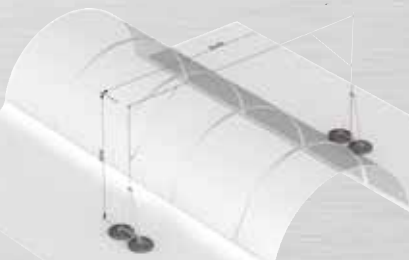

Ord. no. 490 300

Bridging-SET

to bridge continuous rooflights or other roof structures.

Specification	Height x Width	PU	Ord. no.
Aluminium -bridging-set completely \varnothing 16 mm with struts aluminium \varnothing 10 mm and stainless steel fixing elements	1.5 x 2.0 m	1	490 300
	2.0 x 2.5 m	1	490 301
Stainless steel V2A tube \varnothing 20 mm with aluminium bridging-set \varnothing 16 mm, struts aluminium \varnothing 16 mm and stainless steel fixing elements	2.5 x 3.0 m	1	490 302

Please state the dimensions of the object to be bridged when ordering!

Additional types on request.





Insulated conductor support (complete SET)

to raise the conductor leading

Insulated conductor support, to raise the conductor on flat roofs with plastic base 2 kg and Niro-Clip for ø 8 mm *) **Type A (fL)**.

Specification	Height	Insulated-length	PU	Ord. no.
Conductor support GRP ø 16 mm for air termination conductor ø 8 mm / 50 mm ²	0.2 m	0.17 m	1	490 000
	0.3 m	0.27 m	1	490 001
	0.4 m	0.37 m	1	490 002

*) **Type A (fL)** = fixed conductor /leading

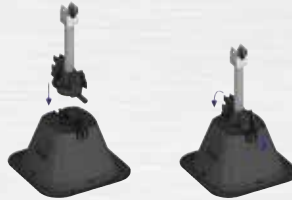

Insulated conductor support, to raise the conductor on flat roofs with square concrete base 16 kg, V2A wedge, support plate and Niro-Clip for ø 8 mm *) **Type A (fL)**.

Specification	Height	Insulated-length	PU	Ord. no.
Conductor support GRP ø 16 mm for air termination conductor ø 8 mm / 50 mm ²	0.6 m	0.45 m	1	490 003
	0.7 m	0.55 m	1	490 004
	0.9 m	0.75 m	1	490 005

*) **Type A (fL)** = fixed conductor /leading

Insulated conductor support, to raise the conductor on flat roofs with round concrete base 25 kg, support plate and clamping frame V2A for ø 8 mm.

Specification	Height	Insulated-length	PU	Ord. no.
Conductor support GRP ø 32 mm for conductor ø 8mm / 50 mm ²	1.1 m	0.94 m	1	490 007
	1.3 m	1.14 m	1	490 008

Air termination tips for insulated conductors on request.

Example of application:

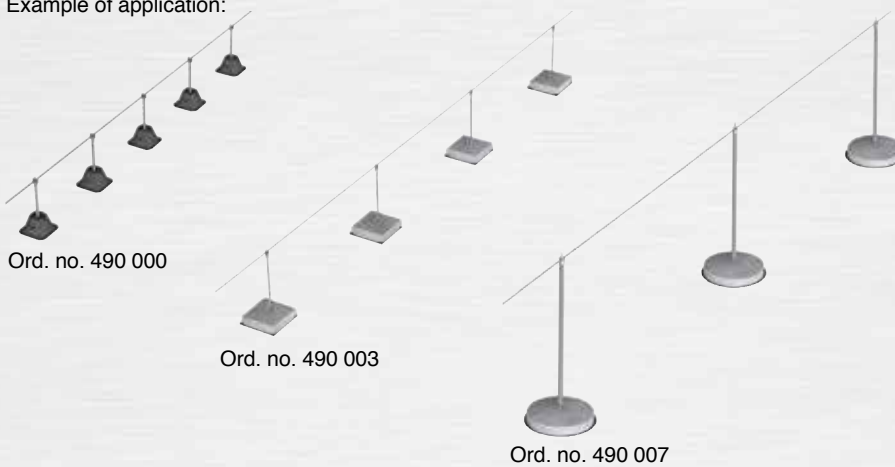

NEW!

Insulated conductor support 16-plus



Ord. no. 490 001

Insulated conductor support 16-plus



Ord. no. 490 003

Insulated conductor support 32-stabil



Ord. no. 490 007



Overview of gust wind speed according to (DIN) EN 1991-1-4 (part of Eurocode) Example: Map of Germany

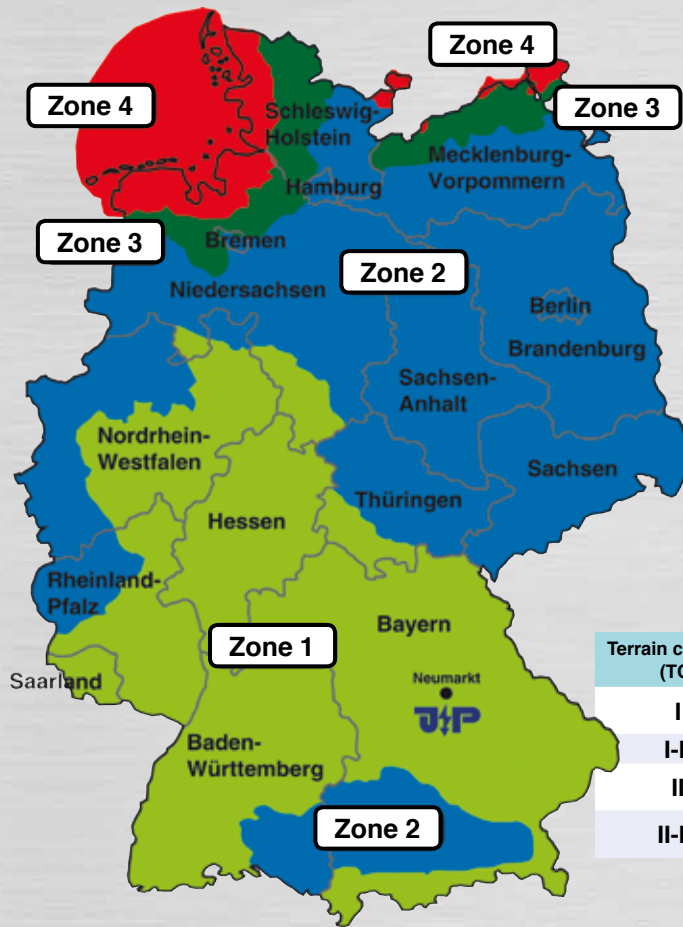

Terrain category (TC)	Description of terrain category (TC)
I	"Open sea; free lakes with at least 5 km surface wind direction; smooth, flat land without barriers."
I-II	Coastline territory, applicable in Zone 3 in most cases.
II	"Terrain with hedges, individual farmsteads, houses or tree, for example agricultural areas."
II-III	Inland, applicable in Zone 1 and Zone 2 in most cases (local land profile is often not clearly defined between TC II & III)

Height above ground in m	Zone 1 $v_{b,0}$ 22.5 m/s		Zone 2 $v_{b,0}$ 25.0 m/s		Zone 3 $v_{b,0}$ 27.5 m/s	Zone 4 $v_{b,0}$ 30.0 m/s
	TC II-III	TC II	TC II-III	TC II	TC I-II	TC I
0	100 km/h	106 km/h	111 km/h	118 km/h	133 km/h	151 km/h
5	100 km/h	109 km/h	111 km/h	120 km/h	137 km/h	160 km/h
10	106 km/h	118 km/h	118 km/h	131 km/h	150 km/h	171 km/h
15	115 km/h	124 km/h	127 km/h	137 km/h	158 km/h	178 km/h
20	121 km/h	129 km/h	134 km/h	142 km/h	165 km/h	182 km/h
25	126 km/h	132 km/h	139 km/h	146 km/h	170 km/h	186 km/h
30	130 km/h	135 km/h	144 km/h	149 km/h	174 km/h	190 km/h
40	138 km/h	140 km/h	152 km/h	154 km/h	181 km/h	195 km/h
50	143 km/h	143 km/h	158 km/h	158 km/h	186 km/h	199 km/h
60	147 km/h	147 km/h	162 km/h	162 km/h	189 km/h	202 km/h
70	150 km/h	150 km/h	165 km/h	165 km/h	192 km/h	205 km/h
100	156 km/h	156 km/h	172 km/h	172 km/h	198 km/h	212 km/h

Notifications regarding static safety:

A 1.5-fold stability safety applies to load-carrying constructions (houses, halls, bridges, radio towers) regarding the measured typical wind loads, i.e. load-carrying constructions must resist 1.5 times of the wind uplifting pressure.

This also applies to air termination poles, the failure or tilting of which can cause major economic damage, subsequential damage or personal damage on exposed positions (above a main building entrance, above a railway track etc.)

The builder or the owner must consider whether the a/m criteria apply to the planned site. If the a/m criteria do not apply, he must assume a 1.0-fold stability safety regarding the characteristic wind loads acc. to standard, i.e. the lightning termination rod can withstand only the maximum characteristic load (=1.5-fold) before it fails or collapses.

For example, a 4m air termination pole positioned at a distance of 10m from the edge of a flat roof with attic can protect an air conditioning against lightning strikes. In case of any doubt whether a 1.0-fold stability safety can be chosen, contact the insurance company. A 1.5-fold stability safety is always a safe approach.

Air termination pole selection guide

Height of air termination pole	Wind Zone	Air termination pole base frame Ord. no.	Concrete base Ord. no.	Max. wind speed		SET-no.
				Static safety factor 1.0	Static safety factor 1.5	
3.0m (Ord. no. 912 000)	Zone 1	499 000	4x 499 100	211 km/h	172 km/h	912 089
	Zone 2	499 000	4x 499 100	211 km/h	172 km/h	
	Zone 3	499 000	4x 499 100	211 km/h	172 km/h	
3.5m (Ord. no. 912 001)	Zone 1	499 000	4x 499 100	177 km/h	145 km/h	912 090
	Zone 2	499 000	4x 499 100	177 km/h	145 km/h	
	Zone 3	499 000	4x 499 101	200 km/h	163 km/h	912 700
4.0m (Ord. no. 912 002)	Zone 1	499 000	4x 499 100	150 km/h	122 km/h	912 705
	Zone 2	499 000	4x 499 101	168 km/h	137 km/h	912 091
	Zone 3	499 000	8x 499 100	200 km/h	163 km/h	912 710
4.5m (Ord. no. 912 003)	Zone 1	499 005	3x 103 101	143 km/h	116 km/h	912 715
	Zone 2	499 005	3x 103 110	154 km/h	126 km/h	912 092
	Zone 3	499 005	3x 103 118	172 km/h	141 km/h	912 720
5.0m (Ord. no. 912 004)	Zone 1	499 005	3x 103 101	139 km/h	114 km/h	912 725
	Zone 2	499 005	3x 103 110	151 km/h	123 km/h	912 093
	Zone 3	499 005	3x 103 118	168 km/h	137 km/h	912 730
5.5m (Ord. no. 912 005) (Ord. no. 912 005 S)	Zone 1	499 005	3x 103 110	134 km/h	110 km/h	912 735
	Zone 2	499 005	3x 103 118	149 km/h	121 km/h	912 094
	Zone 3	499 006	6x 103 103	167 km/h	136 km/h	912 740
6.0m (Ord. no. 912 006)	Zone 1	499 006	6x 103 103	164 km/h	134 km/h	912 095
	Zone 2	499 006	6x 103 103	164 km/h	134 km/h	
	Zone 3	499 006	6x 103 103	164 km/h	134 km/h	
6.5m (Ord. no. 912 007)	Zone 1	499 006	6x 103 103	155 km/h	127 km/h	912 096
	Zone 2	499 006	6x 103 103	155 km/h	127 km/h	
	Zone 3	499 006	6x 103 101	170 km/h	139 km/h	912 745
7.0m (Ord. no. 912 008)	Zone 1	499 006	6x 103 103	136 km/h	111 km/h	912 750
	Zone 2	499 006	6x 103 101	148 km/h	121 km/h	912 097
	Zone 3	499 006	6x 103 110	160 km/h	131 km/h	912 755
7.5m (Ord. no. 912 009)	Zone 1	499 006	6x 103 101	141 km/h	116 km/h	912 760
	Zone 2	499 006	6x 103 110	153 km/h	125 km/h	912 098
	Zone 3	499 006	6x 103 118	168 km/h	137 km/h	912 765
8.0m (Ord. no. 912 010)	Zone 1	499 006	6x 103 118	147 km/h	120 km/h	912 099
	Zone 2	499 006	6x 103 118	147 km/h	120 km/h	
	Zone 3	499 007	10x 103 118	183 km/h	149 km/h	912 770
9.0m (Ord. no. 912 011)	Zone 1	499 007	10x 103 118	163 km/h	133 km/h	914 185
	Zone 2	499 007	10x 103 118	163 km/h	133 km/h	
	Zone 3	499 007	10x 103 118	163 km/h	133 km/h	
10.0m (Ord. no. 912 013)	Zone 1	499 007	10x 103 118	141 km/h	115 km/h	914 186
	Zone 2	499 007	10x 103 118	141 km/h	115 km/h	
	Zone 3	on request				on request
11.0m (Ord. no. 912 015)	Zone 1	499 009 / complete SET		181 km/h	141 km/h	912 061
	Zone 2	499 009 / complete SET		181 km/h	141 km/h	
	Zone 3	on request				on request
12.0m (Ord. no. 912 019)	Zone 1	499 009 / complete SET		177 km/h	145 km/h	912 070
	Zone 2	499 009 / complete SET		177 km/h	145 km/h	
	Zone 3	on request				on request

Air termination poles for Zone 4 on request.

For the installation of air termination poles in Zone 4, further requirements regarding material (near to coast, material selection etc.) must be respected!



Air termination pole - free-standing up to a max. height of 12.0 m

Note: Air termination pole selection guide on page 131.

Air termination pole - stainless steel V2A with aluminium air termination tip. Multi-component, on each other pluggable system with screw locking.

Type	Height of pole	Pole parts	PU	Ord. no.
JP-LPH 3.0 F	3.0 m	2-part, 1.5 m / 1.5 m	1	912 000
JP-LPH 3.5 F	3.5 m	2-part, 2.0 m / 1.5 m	1	912 001
JP-LPH 4.0 F	4.0 m	2-part, 2.5 m / 1.5 m	1	912 002
JP-LPH 4.5 F	4.5 m	2-part, 3.5 m / 1.0 m	1	912 003
JP-LPH 5.0 F	5.0 m	2-part, 3.5 m / 1.5 m	1	912 004
JP-LPH 5.5 F	5.5 m	2-part, 4.0 m / 1.5 m	1	912 005
JP-LPH 6.0 F	6.0 m	3-part, 2.0 m / 2.0 m / 2.0 m	1	912 006
JP-LPH 6.5 F	6.5 m	3-part, 2.5 m / 2.0 m / 2.0 m	1	912 007
JP-LPH 7.0 F	7.0 m	3-part, 3.0 m / 2.0 m / 2.0 m	1	912 008
JP-LPH 7.5 F	7.5 m	3-part, 3.5 m / 2.0 m / 2.0 m	1	912 009
JP-LPH 8.0 F	8.0 m	3-part, 4.0 m / 2.0 m / 2.0 m	1	912 010
JP-LPH 9.0 F	9.0 m	3-part, 4.0 m / 2.5 m / 2.5 m	1	912 011
JP-LPH 10.0 F	10.0 m	3-part, 5.0 m / 2.5 m / 2.5 m	1	912 013
JP-LPH 11.0 F	11.0 m	3-part, 5.0 m / 3.5 m / 2.5 m	1	912 015
JP-LPH 12.0 F	12.0 m	3-part, 6.0 m / 3.5 m / 2.5 m	1	912 019

Additional air termination pole heights on request!

Air termination pole base frame with roof inclination adjustment up to 5°.

For concrete bases 300 x 300 mm to position air termination poles \varnothing 42 mm (e.g. 111 496).

Specification	Footprint	PU	Ord. no.
Stainless steel V2A	ca. 650 x 650 mm	1	499 000
Support plate (one side aluminium-laminated)	ca. 650 x 650 mm	1	499 010
Roof inclination adjustment, inclination up to 10°		1	499 700



Roof inclination adjustment up to 5°

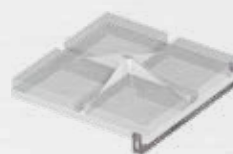

Roof inclination adjustment up to 10°
Ord. no. 499 700.

Concrete base

Specification	Weight	PU	Ord. no.
Concrete base round	12 kg	1	103 103
with female thread M16	16 kg	1	103 101
for the base frame	20 kg	1	103 110
	25 kg	1	103 118
Concrete base, 300 x 300 x 60 mm	12 kg	1	499 100
Concrete base, 300 x 300 x 80 mm	16 kg	1	499 101
Support plate, plastic black - without plasticizer		1	103 102

Air termination rod SET - stainless steel V2A with air termination tip aluminium.

with stainless steel V2A angular frame V2A 50x50x5mm for 2 or 3 concrete bases.

Specification	Footprint (mm)	Concrete base (optional)	Wind speed Static safety factor 1.5	Height	Ord. no.
Stainless steel V2A / aluminium	ca. 930 x 380	2x 16 kg (Ord. no. 103 101)	150 km/h	2.5 m	912 500
Stainless steel V2A / aluminium	ca. 970 x 420	2x 25 kg (Ord. no. 103 118)	157 km/h	3.0 m	912 501
Stainless steel V2A / aluminium	ca. 970 x 830	3x 25 kg (Ord. no. 103 118)	147 km/h	3.5 m	912 502

Note:

Concrete bases (round) and support plates (ord. no. 103 102) must be ordered separately.

Air termination pole base frame

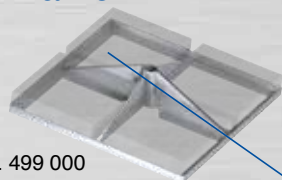

Ord. no. 499 000

Support plate



Ord. no. 499 010

Concrete base



Ord. no. 103 103



Ord. no. 499 100

Air termination rod SET



Ord. no. 912 500



Ord. no. 912 502



Air termination pole base frame

with a 2- or 3-part base frame for roof inclinations up to 3°.

Air termination pole base frame, with **2-part base frame** and 3 safety braces for 3 round concrete bases for air termination poles \varnothing 42 mm (max. 5.5 m pole height).

Specification	Pole base frame	Footprint	PU	Ord. no.
Stainless steel V2A	2-part	ca. 1350 x 1350 mm	1	499 005

Base frame



Ord. no. 499 005



Ord. no. 499 006



Ord. no. 499 007

Air termination pole base frame, with **2-part base frame** and 3 safety braces for 6 round concrete bases for air termination poles \varnothing 60 mm (max. 8.0 m pole height).

Specification	Pole base frame	Footprint	PU	Ord. no.
Stainless steel V2A	2-part	ca. 1850 x 1850 mm	1	499 006

Air termination pole base frame, with **3-part base frame** and 3 safety braces for 6 round concrete bases for air termination poles \varnothing 60 mm (max. 10.0 m pole height).

Specification	Pole base frame	Footprint	PU	Ord. no.
Stainless steel V2A	3-part	ca. 1850 x 1850 mm	1	499 007

Note:

Concrete bases (round) and support plates (ord. no. 103 102) must be ordered separately.

Air termination pole base frame - SET incl. 36 concrete bases with 4 safety braces and turnbuckle. For air termination poles \varnothing 60 mm (max. 12.0 m pole height).

Specification	Footprint	PU	Ord. no.
Stainless steel V2A	ca. 3400 x 3400 mm	1	499 009

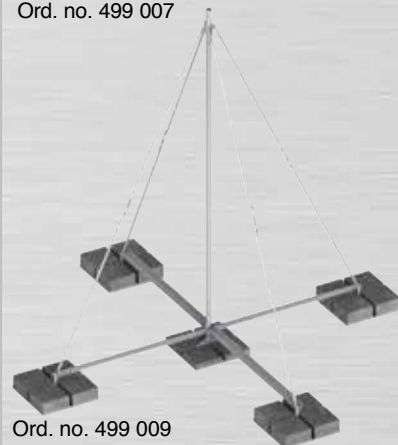

Ord. no. 499 009

Roof inclination adjustment for air termination poles for roof inclinations up to 10°. **NEW!**

Roof inclination adjustment, complete angle SET, stainless steel V2A with screw accessories.

Specification	for base frames with 3 round concrete bases	PU	Ord. no.
Stainless steel V2A	ord. no. 499 005	1	499 500



Ord. no. 499 500

Roof inclination adjustment, complete angle SET, stainless steel V2A with screw accessories.

Specification	for base frames with 6 round concrete bases	PU	Ord. no.
Stainless steel V2A	ord. no. 499 006	1	499 600

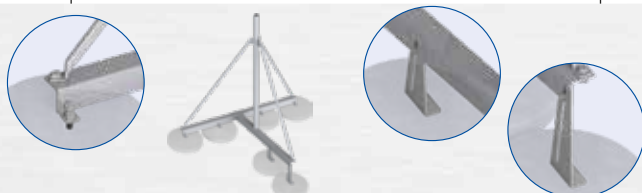

Ord. no. 499 600



Air termination pole for wall mounting unsupported for poles up to max. 12.0 m length

Air termination pole - stainless steel V2A with aluminium air termination tip.
Multi-component, on each other pluggable system with screw locking.
Incl. connection lug with clamping screw "KS" and slip-proofing.

Height of pole	Necessary wall fastener	Pole parts	PU	Ord. no.
3.0 m	2x Type A	2-part, 1.5 m / 1.5 m	1	912 000 W
3.5 m	2x Type A	2-part, 2.0 m / 1.5 m	1	912 001 W
4.0 m	2x Type A	2-part, 2.5 m / 1.5 m	1	912 002 W
4.5 m	2x Type B	2-part, 3.5 m / 1.0 m	1	912 003 W
5.0 m	2x Type B	2-part, 3.5 m / 1.5 m	1	912 004 W
5.5 m	2x Type B	2-part, 4.0 m / 1.5 m	1	912 005 W
6.0 m	2x Type C	3-part, 2.0 m / 2.0 m / 2.0 m	1	912 006 W
6.5 m	2x Type C	3-part, 2.5 m / 2.0 m / 2.0 m	1	912 007 W
7.0 m	2x Type C	3-part, 3.0 m / 2.0 m / 2.0 m	1	912 008 W
7.5 m	2x Type C	3-part, 3.5 m / 2.0 m / 2.0 m	1	912 009 W
8.0 m	2x Type C	3-part, 4.0 m / 2.0 m / 2.0 m	1	912 010 W
9.0 m	3x Type C	3-part, 4.0 m / 2.5 m / 2.5 m	1	912 011 W
10.0 m	3x Type C	3-part, 5.0 m / 2.5 m / 2.5 m	1	912 013 W
11.0 m	3x Type C	3-part, 5.0 m / 3.5 m / 2.5 m	1	912 015 W
12.0 m	3x Type C	3-part, 6.0 m / 3.5 m / 2.5 m	1	912 019 W

Wall fastener

Type A:



Ord. no. 490 550

Type B:

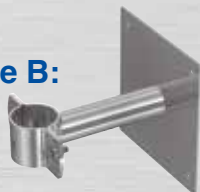

Ord. no. 490 560

Type C:

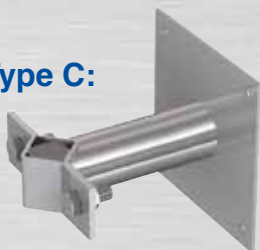

Ord. no. 490 570

Fixing anchors



Ord. no. 490 548

Wall fastener for poles with a max. height of 4.0 m and \varnothing 42 mm.
Hole pattern for rivet and screw mounting and 2 x \varnothing 10.5 mm.

Specification	Wall distance	PU	Ord. no.
Completely in stainless steel V2A for \varnothing 42 mm	150 mm	1	490 550
pole clamp with 2 x screws M10	200 mm	1	490 551
spring lock washer and nut in V2A	250 mm	1	490 552
	300 mm	1	490 553

Wall fastener for poles with a max. height of 5.5 m and \varnothing 42 mm.
Hole pattern 4x \varnothing 10,5 mm.

Specification	Wall distance	PU	Ord. no.
Completely in stainless steel V2A for \varnothing 42 mm	150 mm	1	490 560
pole clamp with 2 x screws M10,	200 mm	1	490 561
spring lock washer and nut in V2A	250 mm	1	490 562
mounting plate V2A: 200 x 200 x 8 mm	300 mm	1	490 563
hole pattern mounting plate: \square 170 x 170 mm			

Wall fastener for poles with a max. height of 12.0 m and \varnothing 60 mm.
Hole pattern 4 x \varnothing 12.5 mm.

Specification	Wall distance	PU	Ord. no.
Completely in stainless steel V2A for \varnothing 60 mm	150 mm	1	490 570
pole clamp with 2 x screws M16,	200 mm	1	490 571
spring lock washer and nut in V2A	250 mm	1	490 572
mounting plate V2A: 300 x 300 x 8 mm	300 mm	1	490 573
hole pattern mounting plate: \square 260 x 260 mm			

Fixing anchors, stainless steel V4A for wall fastener on concrete walls.

Specification	PU	Ord. no.
M10 for wall fastener Type A and Type B	1	490 548
M12 for wall fastener Type C	1	490 549



Telescopic-air termination pole, free-standing aluminium with base frame for roof inclinations up to 10°

Benefits:

- Less space required for storage and in transport vehicle (**transport / delivery length ca. 2 m**).
- Adjustment of roof inclination up to max. 10°.
- Easy transport in lifts, staircases and through roof openings.
- Shorter and easier assembly of the air termination pole with self-locking set screws M8 or M10.
- Pole heights in the SET adjustable up to 4.35 m, 5.5 m, 6.5 m & 8.0 m.
- Statically calculated according to Eurocode (EC)

Telescopic-air termination pole-SET in aluminium, freestanding incl. base frame with roof inclination adjustment, concrete bases and support plates.

Height of pole	Pole parts	Base frame	Concrete base	Ord. no.
up to 4.35 m	4-part	499 000 (5°)	4x 16 kg	912 601
up to 5.50 m	4-part	912 300 (10°)	3x 25 kg	912 600
up to 6.50 m	5-part	912 310 (10°)	6x 12 kg	912 602
up to 8.00 m	6-part	912 311 (10°)	6x 25 kg	912 603

Note: The air termination pole base frame must be secured against slipping from a roof inclination of 5°.

Roof inclination adjustment up to 10° (ord. no. 499 700) for the base frame (ord. no. 499 000) see on page 132.

Wind speed according to Eurocode:

Height of pole	SET ord. no.	Wind speed	
		Static safety factor 1.0	Static safety factor 1.5
up to 4.35 m	912 601	146 km/h	119 km/h
up to 5.50 m	912 600	161 km/h	130 km/h
up to 6.50 m	912 602	142 km/h	116 km/h
up to 8.00 m	912 603	155 km/h	127 km/h

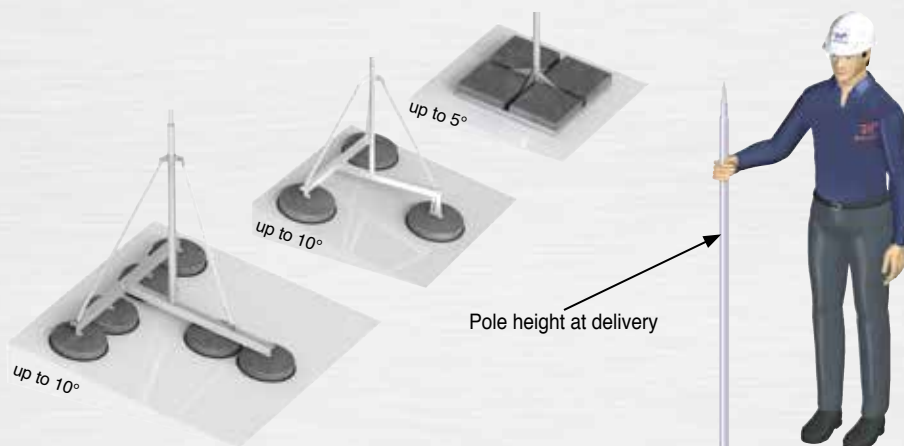

NEW!



Telescopic-air termination pole aluminium for wall mounting unsupported up to 6.5 m air termination pole height (mounting length 1.5m)

Height of pole	Pole parts	Necessary wall fastener	PU	Ord. no.
up to 4.35 m	4-part	2x Type A, (on page 134)	1	912 401
up to 5.35 m	4-part	2x Type B, (on page 134)	1	912 400
up to 6.50 m	5-part	2x Type C, (on page 134)	1	912 402
up to 8.00 m	6 part	2x Type C, (on page 134)	1	912 403

Ord. no. 912 603



Lightning protection - air termination pole for block foundations

This system was developed to protect objects and installations, such as areas with potentially explosive atmospheres, power distributors, transformer stations, biogas plants or other facilities with especially hazardous areas.

To ensure compliance with the valid standard EN 62305 1-4 we recommend the installation of an insulated lightning air termination system using air termination poles. With this method, it is also possible to completely encase larger objects within a protective zone and avoid bridging horizontally installed air termination conductors.

The air termination pole is embedded in a concrete block foundation that must be prefabricated on site according to our instructions. Please request our data sheet JP-LPH/BFM, with all the important information about the block foundation.

Lightning protection pole - Steel, hot galvanized (inside and outside). Multi-part, conic pluggable system with air termination rod (0.3 m - 1.5 m) and earthing connection.

Type	Height (H)	Pole diameter		Weight (entire pole)	Parts	Ord. no.
		top	bottom			
JP-LPH 9.5	9.5 m	58 mm	153 mm	ca. 100 kg	3 -part	920 700
JP-LPH 10.5	10.5 m	58 mm	153 mm	ca. 101 kg	3 -part	920 701
JP-LPH 11.5	11.5 m	89 mm	189 mm	ca. 158 kg	3 -part	920 702
JP-LPH 14.0	14.0 m	58 mm	189 mm	ca. 181 kg	4 -part	920 703
JP-LPH 15.0	15.0 m	89 mm	224 mm	ca. 256 kg	4 -part	920 704
JP-LPH 16.0	16.0 m	89 mm	224 mm	ca. 257 kg	4 -part	920 705
JP-LPH 17.5	17.5 m	108 mm	264 mm	ca. 361 kg	4 -part	920 706
JP-LPH 18.5	18.5 m	108 mm	264 mm	ca. 362 kg	4 -part	920 707
JP-LPH 20.5	20.5 m	89 mm	264 mm	ca. 385 kg	5 -part	920 708
JP-LPH 22.0	22.0 m	139 mm	344 mm	ca. 737 kg	3 -part	920 709
JP-LPH 25.0	25.0 m	108 mm	344 mm	ca. 790 kg	4 -part	920 710
JP-LPH 28.0	28.0 m	89 mm	344 mm	ca. 813 kg	5 -part	920 711

Note:

All air termination poles are suitable for Wind Zone 2 up to 150 km/h. Wind Zone 3/4 and other dimensions on request.



Insulated lightning protection



Lightning protection - air termination pole – SET with prefabricated concrete foundation

Benefits:

- Air termination pole entirely in stainless steel.
- Prefabricated foundation including transport aid.
- Air termination pole max. 4m pole-part length.
- No trench works.
- Statically tested, taking into account
 - Ice accretion.
 - Gust reaction factor.
 - Static safety factor 1.5, required due to building authorities.
- Everything from one source.

Air termination pole - SET with flange plate, complete in stainless steel with aluminium tip and prefabricated foundation for max. Wind Zone 2 including transport aid.

Type	Height (H)	Foundation	Total weight	Ord. no.
JP-BFF 10.0	10.0 m	ø 0.96 m / FH 0.5 m	ca. 970 kg	912 200
JP-BFF 11.0	11.0 m	ø 0.96 m / FH 0.5 m	ca. 975 kg	912 201
JP-BFF 12.0	12.0 m	ø 0.96 m / FH 0.5 m	ca. 985 kg	912 202
JP-BFF 13.0	13.0 m	ø 1.16 m / FH 0.5 m	ca. 1420 kg	912 203
JP-BFF 14.0	14.0 m	ø 1.16 m / FH 0.5 m	ca. 1425 kg	912 204
JP-BFF 15.0	15.0 m	ø 1.16 m / FH 0.75 m	ca. 2030 kg	912 205
JP-BFF 16.0	16.0 m	ø 1.16 m / FH 0.75 m	ca. 2085 kg	912 206
JP-BFF 17.0	17.0 m	ø 1.16 m / FH 1.0 m	ca. 2790 kg	912 207
JP-BFF 18.0	18.0 m	ø 1.16 m / FH 1.0 m	ca. 2800 kg	912 208

Note:

All air termination poles are suitable for Wind Zone 2 up to 150 km/h.
Wind Zone 3/4 and other dimensions on request.



Prefabricated foundation incl. transport aid

Prefabricated foundation with 4 anchors made of stainless steel (M16 or M20) for easy installation of the air termination pole.



Air termination pole -SET

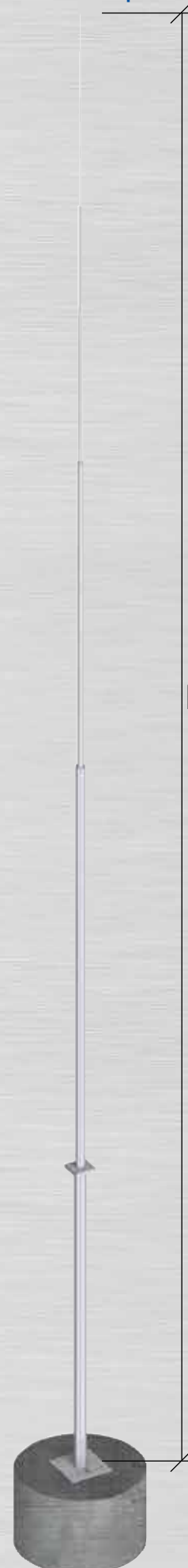



JP-MBF system (JP utility patent)

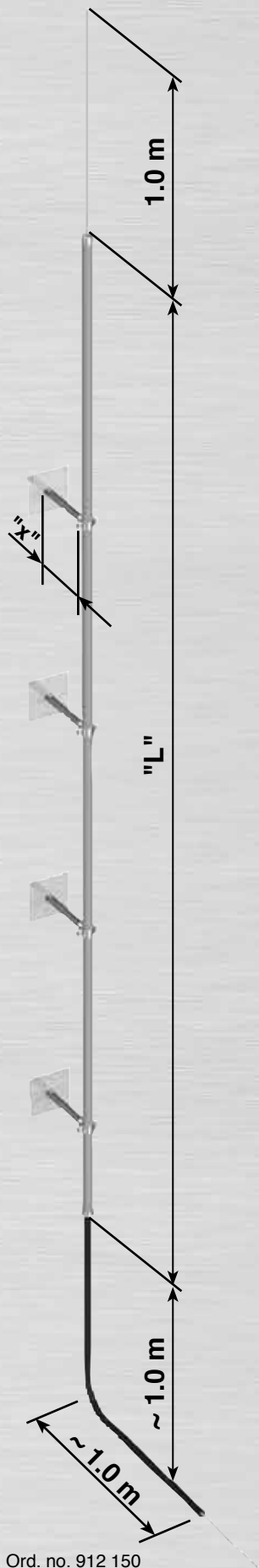

Ord. no. 912 150

JP-MBF system -

Partially insulated air termination and down conductor system to reduce the separation distance.

Version W - Complete SET

Specification

Fastening: 4 x insulated stand-off GRP and mounting plate
stainless steel V2A 200 x 200 mm; Hole pattern: 8x ø 6.5 mm

Pole design: GRP ø 48 mm with interior insulated down conductor
(PE ø 32 mm and 50 mm² aluminium conductor)

Air termination tip: Aluminium ø 10 mm, 1000 mm long

up to 0.8 m separation distance in air

Specification	Length (L)	Stand-off length (x)	PU	Ord. no.
Complete-SET	3500 mm	400 mm	1	912 150
	4500 mm	400 mm	1	912 155

up to 1.6 m separation distance in air

Specification	Length (L)	Stand-off length (x)	PU	Ord. no.
Complete-SET	3500 mm	800 mm	1	912 160
	4500 mm	800 mm	1	912 165

Additional lengths on request!





Protection measures against touch voltages

Complete-SET, total length 3.0 m with test joint (disconnection clamp) and conductor holder

Specification	Fit	PU	Ord. no.
Complete-SET consisting of:		1	912 120
1. Insulation with length of: 3.0 m (PE with GRP-coat in light grey)	ø 22 mm		
2. Interior conductor, length: 4.0 m: Material under disconnection clamp: Stainless steel V4A Material over disconnection clamp: Aluminium	ø 10 mm ø 10 mm		
3. Tested disconnection clamp			
4. Conductor holder (5 pc.)	ø 22 mm		

Down conductor-SET, total length 3.0 m (without disconnection clamp)

Specification	Fit	PU	Ord. no.
Consisting of:		1	912 121
1. Length of insulation: 3.0 m (PE with GRP-coat in light grey)	ø 22 mm		
2. Interior conductor, stainless steel V4A , length: 4.0 m	ø 10 mm		

Conductor holder

Specification	Fit	PU	Ord. no.
Stainless steel V2A , with spacer (h= 20 mm), screw and dowel.	ø 22 mm	1	912 122 

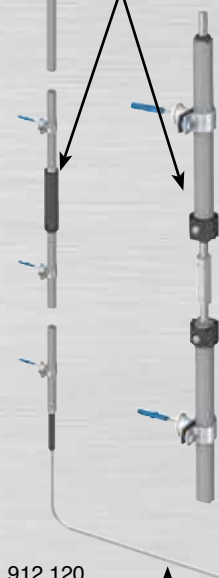
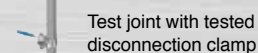
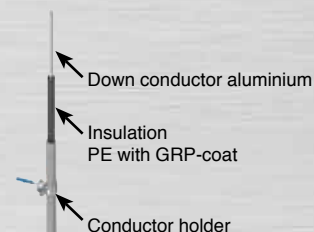

Ord. no. 912 120
Stainless steel earth terminal lug

Down conductor-SET



Ord. no. 912 121

Conductor holder



Ord. no. 912 122



Test laboratory with 10/350 μ s impulse current generator

In our test laboratory, all lightning protection components and surge protective devices are tested according to the latest national and international standards.



Equipment for environmental testing





HVC-protected

High voltage resistant insulated conductor

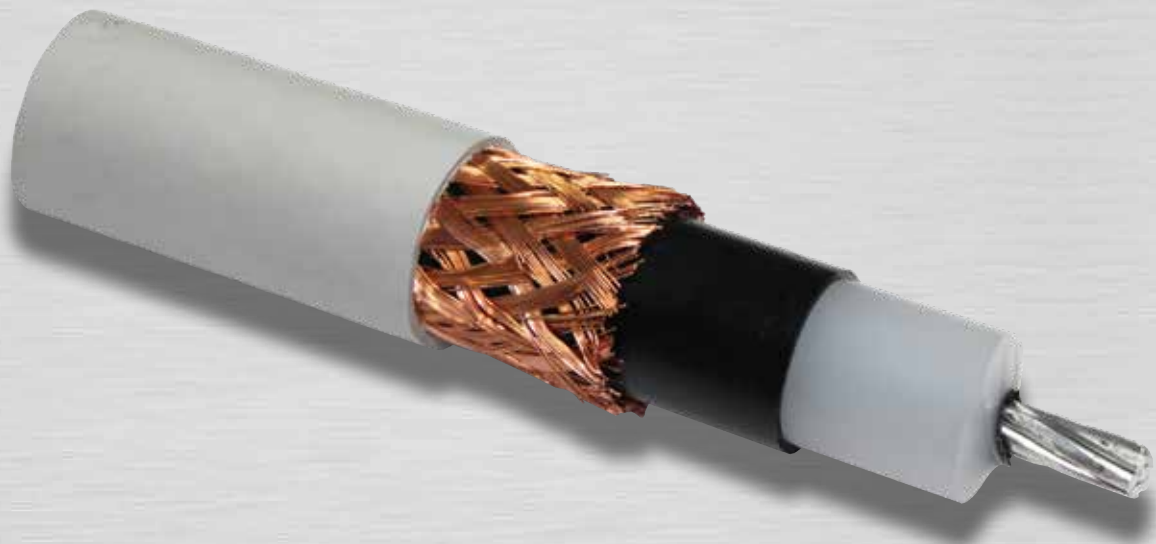



Installation example



HVC-protected

Benefits of the HVC conductor:

- Significantly reduced installation work and time.
- The required equipotential bonding is provided by the integrated shield braid in the conductor – no separate conductor is needed.
- Mechanical and chemical protection by light grey, UV-resistant protective jacket.
- Equivalent separation distance “s” = **0.85 m** in air.
- No additional separation distances must be observed in the base area.

Installation is carried out in accordance with the installation instructions.

Design and technical data:

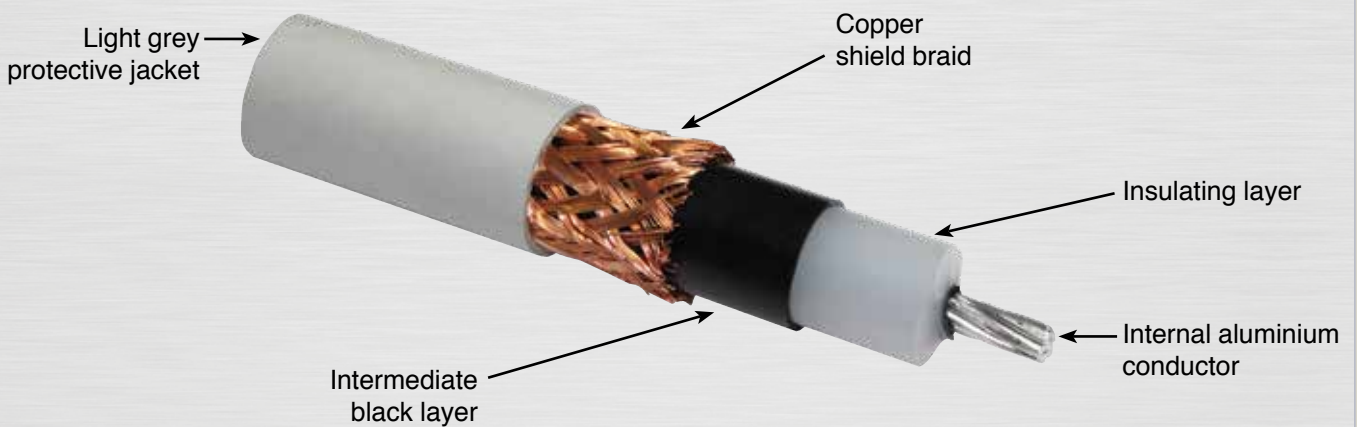

Equivalent separation distance “s” - air	≤ 850 mm
Equivalent separation distance “s” - solid material	≤ 1700 mm
Outer diameter	28.0 mm (± 1.0 mm)
Minimum bending radius	250 mm
Ambient temperature during installation	> 0°C
Permanent temperature range	-20°C to +70°C
Max. tensile load	1500 N
Weight	ca. 0.918 kg/m
Cross section of stranded internal aluminium conductor	28 mm ² / aluminium
Cross section of shield braid	23 mm ² / copper
Fire load	5.83 kWh/m
Weatherproof and UV-resistant	yes

Maximal conductor length:

Class of LPS	Max. lightning current	No. of down conductors	Max. conductor length *)
I	200 kA	1	--
		2	21 m
		3	32 m
II	150 kA	1	14 m
		2	28 m
		3	42 m
III + IV	100 kA	1	21 m
		2	42 m
		3	64 m

*) : for "s" = 0.85 m in air



HVC-conductor

Specification	Fit	ca. Weight/m	PU.	Order no.
Length 25 m as a bunch	ø 28 mm	0.918 kg	1	600 001
Length 50 m on a non-returnable reel	ø 28 mm	0.918 kg	1	600 002
Length 100 m on a non-returnable reel	ø 28 mm	0.918 kg	1	600 003

Technical data:

Equivalent separation distance "s" - air	≤ 850 mm
Equivalent separation distance "s" - solid material	≤ 1700 mm
Outer diameter	28.0 mm (± 1.0 mm)
Minimum bending radius	250 mm
Ambient temperature during installation	> 0°C
Permanent temperature range	-20°C to +70°C
Max. tensile load	1500 N
Weight	ca. 0.918 kg/m
Cross section of stranded internal aluminium conductor	28 mm ² / aluminium
Cross section of shield braid	23 mm ² / copper
Fire load	5.83 kWh/m
Weatherproof and UV-resistant	yes

List of maximal conductor lengths (while "s" = 0.85 in air) on page 143

Head-unit

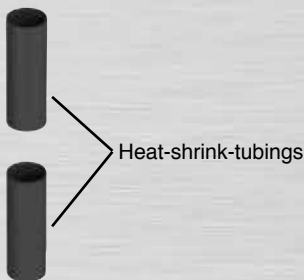
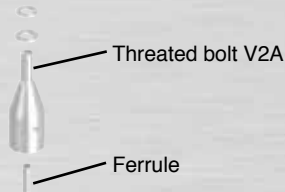

Order no. 601 101

Head-unit

Head-unit, incl. a complete installation set consisting of 2 heat-shrink-tubings, ferrule, washer and springwasher.

Specification	Connection	PU	Order no.
Aluminium - for exterior pole installation	Hex bolt V2A M10 x 35 mm with a locknut	1	601 100
Aluminium - for interior pole installation	Threaded bolt V2A	1	601 101
Aluminium - for spanning objects incl. multi-clamp V2A	Threaded bolt V2A	1	601 102

Head-unit made of stainless steel V2A on request!

Application examples:



Head-unit
order no. 601 100 +
terminal plate
order no. 632 400
(see page 155)



Head-unit
order no. 601 101



Head-unit
order no. 601 102

Spare parts, for head-unit

Specification	Fit	Length	PU	Order no.
Ferrule copper/tinned	ø 7 mm	30 mm	10	601 110
Heat-shrink-tubing with glue	ø 32 mm	100 mm	10	601 111



HVC-conductor incl. installed head-unit

HVC-conductor, cut to length with installed head-unit. Including base unit **aluminium** for self-assembly. Minimum length of HVC-conductor: 5.0 m.

Specification of head-unit (page 144)	Order no. 5.0 m	Order no. xx m
Aluminium - for exterior pole installation	601 100-5	601 100-xx
Aluminium - for interior pole installation	601 101-5	601 101-xx
Aluminium - for spanning objekts incl. multi-clamp V2A	601 102-5	601 102-xx

Head-unit made of **stainless steel V2A** on request!

The last digits of the order no. (**xx**) indicate the overall conductor length.

Order example: 601 100-10

Head-unit 601 100

Base-unit is included in delivery
but not assembled

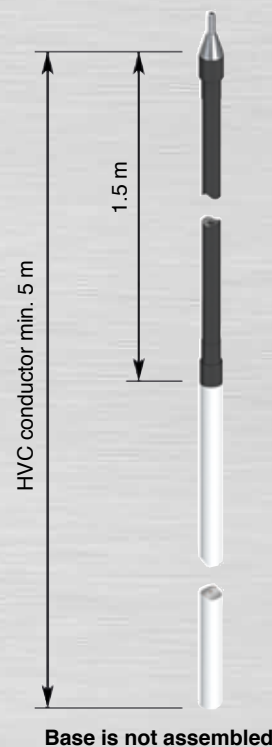

Base-unit

Base-unit, incl. terminal bolt \varnothing 10 mm made of **stainless steel V2A** and a complete installation set consisting of a heat-shrink-tubing, contact sheet and a ferrule.

Specification	Fit	Length	PU	Order no.
Aluminium	\varnothing 10 mm	70 mm	1	601 200

Base-unit made of **stainless steel V2A** on request

Application examples:

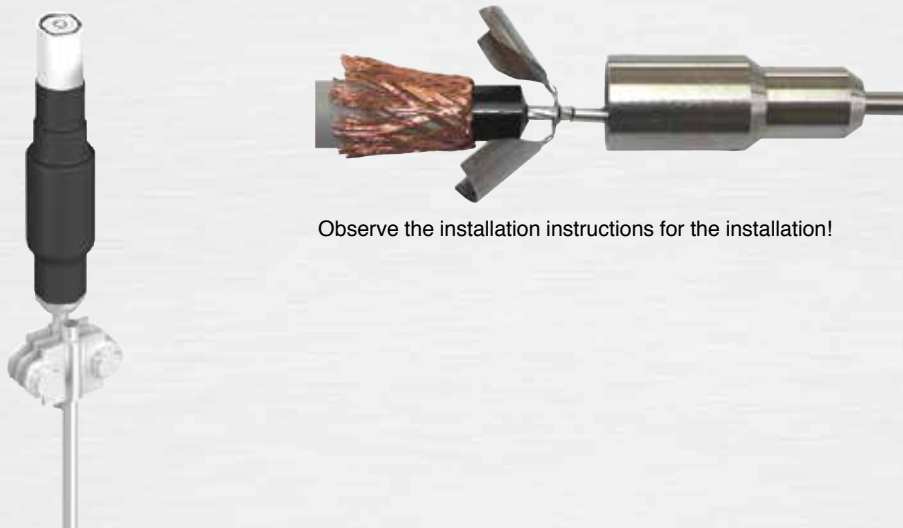

Observe the installation instructions for the installation!

Base-unit
order no. 601 200 +
Vario-clamp
order no. 910 579

Spare parts, for base-unit

Specification	Fit	Length	PU	Order no.
Ferrule copper/tinned	\varnothing 7 mm	30 mm	10	601 110
Heat-shrink-tubing with glue	\varnothing 52 mm	150 mm	5	601 112
Contact sheet stainless steel V2A	\varnothing 7 mm		5	601 113

Base

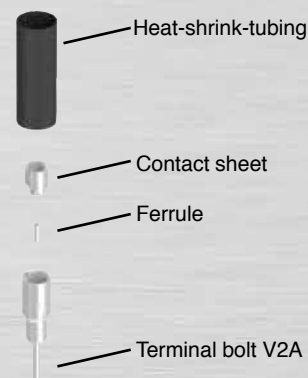

Order no. 601 200



Air termination pole

Free-standing up to a height of 8,0 m

Air termination pole SET for HVC-conductor, free-standing

Specification according to EN 62305-3 / EN 62561-2:

Air termination tip: Aluminium 0.4 m above air termination conductor height
Insul. support: GRP 1.7 m
Stand pipe length: Stainless steel V2A variable, with opening to insert the HVC conductor
 Including air termination pole base frame, concrete bases and support plates

Total height	Pole parts	Pole base frame order no.	Concrete base order no.	Footprint	Order no.
3.0 m	1-part	499 000	4 x 499 100	0.65 x 0.65 m	632 000
4.0 m	1-part	499 005	3 x 103 101	1.33 x 1.28 m	632 001
5.0 m	1-part	499 005	3 x 103 118	1.37 x 1.32 m	632 002
6.0 m	2-part	499 006	6 x 103 101	1.87 x 1.66 m	632 003
7.0 m	2-part	499 006	6 x 103 110	1.87 x 1.66 m	632 004
8.0 m	2-part	499 007	10 x 103 110	1.90 x 1.75 m	632 005

Wind speed according to Eurocode:

Air termination pole height	Order no.	Wind speed	
		Static safety factor 1.0	Static safety factor 1.5
up to 3.00 m	632 000	150 km/h	123 km/h
up to 4.00 m	632 001	171 km/h	140 km/h
up to 5.00 m	632 002	137 km/h	111 km/h
up to 6.00 m	632 003	156 km/h	127 km/h
up to 7.00 m	632 004	143 km/h	117 km/h
up to 8.00 m	632 005	157 km/h	128 km/h

Design of air termination pole (application example):

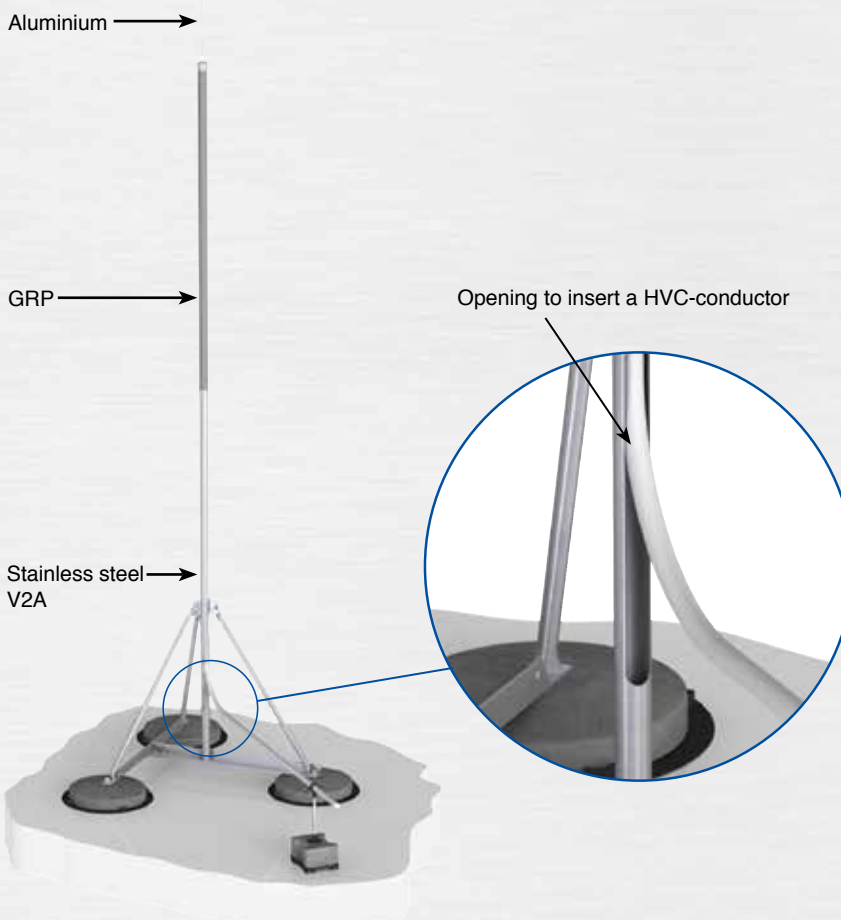

Air termination pole order no. 632 001 + Insulated support order no. 624 011



Order no. 632 000



Order no. 632 003



Air termination pole for wall mounting

unsupported up to a height of 8.0 m

Air termination pole for HVC-conductor, self-supporting

Specification according to (DIN) EN 62305-3 / (DIN) EN 62561-2:

Air termination tip: Aluminium 0.4 m above air termination conductor height

Insul. support: GRP 1.7 m

Stand pipe length: Stainless steel V2A variable

Total height	Pole parts	Necessary wall fastener	Order no.
3.0 m	1-part	2x Type A	632 200
4.0 m	1-part	2x Type A	632 201
5.0 m	1-part	2x Type B	632 202
6.0 m	2-part	2x Type C	632 203
7.0 m	2-part	2x Type C	632 204
8.0 m	2-part	2x Type C	632 205

Wall fastener for poles with HVC-conductor up to max. height of 4.0 m and \varnothing 42 mm.

Hole pattern for rivet and screw mounting and 2 x \varnothing 10.5 mm.

Specification	Wall distance	PU	Ord. no.
Completely in stainless steel V2A for \varnothing 42 mm	150 mm	1	490 550
pole clamp with 2 x screws M10	200 mm	1	490 551
spring lock washer and nut V2A	250 mm	1	490 552
	300 mm	1	490 553

Wall fastener for poles with HVC conductor up to max. height of 5.5 m and \varnothing 42 mm.

Hole pattern 4x \varnothing 10.5 mm.

Specification	Wall distance	PU	Ord. no.
Completely in stainless steel V2A for \varnothing 42 mm	150 mm	1	490 560
pole clamp with 2 x screws M10	200 mm	1	490 561
spring lock washer and nut V2A	250 mm	1	490 562
mounting plate V2A: 200 x 200 x 8 mm	300 mm	1	490 563
hole pattern mounting plate: \square 170 x 170 mm			

Wall fastener for poles with HVC conductor up to max. height of 8.0 m and \varnothing 60 mm.

Hole pattern 4 x \varnothing 12.5 mm.

Specification	Wall distance	PU	Ord. no.
Completely in stainless steel V2A for \varnothing 60 mm	150 mm	1	490 570
pole clamp with 2 x screws M16	200 mm	1	490 571
spring lock washer and nut V2A	250 mm	1	490 572
mounting plate V2A: 300 x 300 x 8 mm	300 mm	1	490 573
hole pattern mounting plate: \square 260 x 260 mm			

Fixing anchors, stainless steel V4A for wall fastener on concrete walls.

Specification	PU	Ord. no.
M10 for wall fastener Type A and Type B	1	490 548
M12 for wall fastener Type C	1	490 549



Order no. 632 200

Wall fastener

Type A



Order no. 490 550

Type B

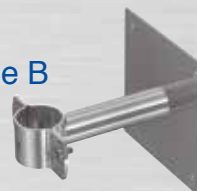

Order no. 490 560

Type C

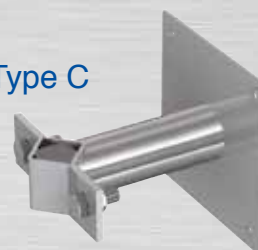

Order no. 490 570

Fixing anchors



Order no. 490 548



HVC-conductor fastener



Order no. 612 003



Order no. 614 003



Order no. 612 001



Order no. 614 001

HVC-conductor fastener

HVC-conductor fastener

Specification	Fixing	Fit	PU	Order no.
Stainless steel V2A	ø 6.5 mm	ø 28 mm	50	612 003
Stainless steel V2A	ø 8.5 mm	ø 28 mm	50	612 002
Plastic	ø 6.5 mm	ø 28 mm	50	614 003

Application:



Delivery state

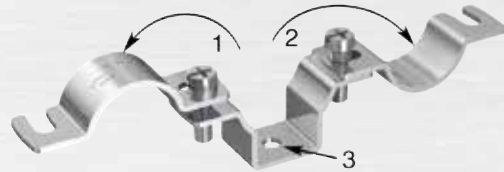

- 1 Open top fastener piece
- 2 Open bottom fastener piece
- 3 Mount conductor fastener

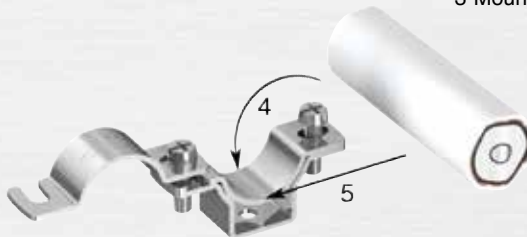

- 4 Swivel back bottom fastener piece
- 5 Insert HVC-conductor into fastener



- 6 Close top fastener piece and tighten screws



Screws in top part are self-retaining

HVC-conductor fastener, with washer, screw and ø 8 mm dowel.

Specification	Conductor height	Fit	PU	Order no.
Stainless steel V2A	18 mm	ø 28 mm	50	612 001
Plastic	13 mm	ø 28 mm	50	614 001



Roof conductor holder

Roof conductor holder, for flat roofs with HVC conductor fastener \varnothing 28 mm, including concrete base (H-shape) and base plate

Specification	Concrete block	Fit	PU	Order no.
Stainless steel V2A with concrete block	5.0 kg	\varnothing 28 mm	1	622 000 
Stainless steel V2A with concrete block	7.5 kg	\varnothing 28 mm	1	622 001
Plastic with concrete block	5.0 kg	\varnothing 28 mm	1	624 000
Plastic with concrete block	7.5 kg	\varnothing 28 mm	1	624 001

Roof conductor holder

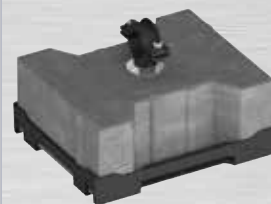

Order no. 624 000

Roof conductor holder, for universal use with HVC conductor fastener \varnothing 28 mm.

Specification	Length	Fit	PU	Order no.
Stainless steel V2A	210 mm	\varnothing 28 mm	1	612 080 
Stainless steel V2A	280 mm	\varnothing 28 mm	1	612 081
Stainless steel V2A	410 mm	\varnothing 28 mm	1	612 082

(J.P. patent)



Order no. 612 080

Roof conductor holder, for Kalzip with HVC conductor fastener \varnothing 28 mm.

Specification	Fastener	Fit	PU	Order no.
Support				
Stainless steel V2A	Stainless steel V2A	\varnothing 28 mm	25	612 060 
Stainless steel V2A	Plastic	\varnothing 28 mm	25	614 060



Order no. 614 060



Order no. 614 070

Roof conductor holder, for RIB-ROOF 500 with HVC conductor fastener \varnothing 28 mm.

Specification	Fastener	Fit	PU	Order no.
Support				
Stainless steel V2A	Stainless steel V2A	\varnothing 28 mm	25	612 070 
Stainless steel V2A	Plastic	\varnothing 28 mm	25	614 070



Mounting stand-offs - - light-weight design Individual combinations!

16plus⁺

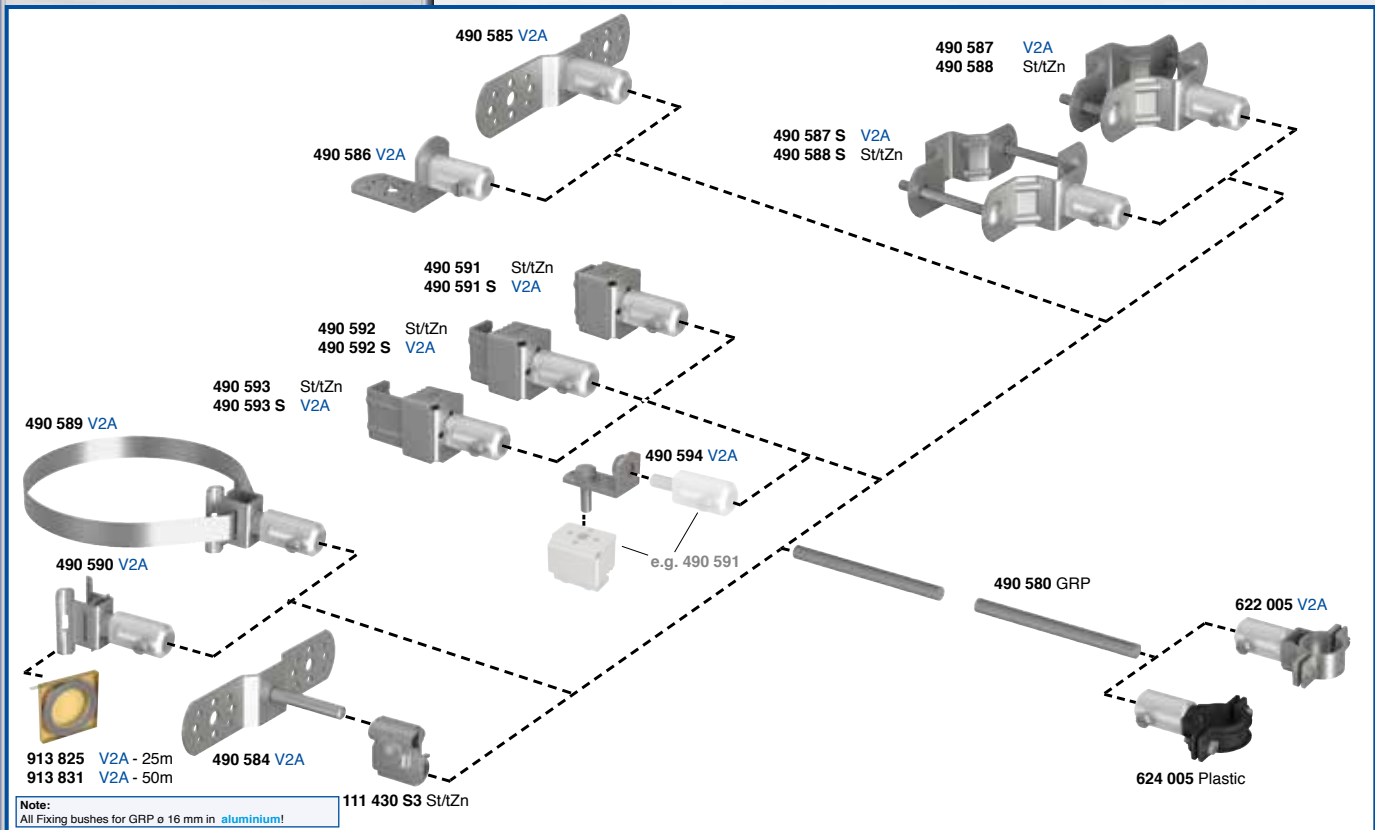

Note:
All Fixing bushes for GRP ø 16 mm in **aluminium!**

Fixing bush



Order no. 622 005



Order no. 624 005

Solid rod GRP

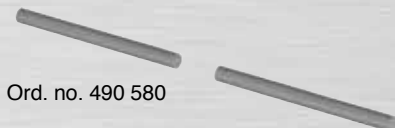

Ord. no. 490 580

Fixing side conductor:

Fixing bush, with HVC conductor fastener ø 28 mm
for fixing to the solid rod GRP ø 16 mm.

Specification	Length	PU	Order no.
Fixing bush aluminium , for GRP ø 16 mm; with HVC conductor fastener, stainless steel V2A	40 mm	25	622 005
with HVC conductor fastener, Plastic	40 mm	25	624 005

Solid rod GRP:

Solid rod GRP to be cut to length.

Specification	Length	PU	Ord. no.
Solid rod GRP, ø 16 mm	3.0 m	10	490 580



Fixing side object:

Mounting plate and angle bracket for mounting on walls and metal sheets, with fixing bush **aluminium**, for GRP \varnothing 16 mm.

Specification	PU	Ord. no.
Mounting plate stainless steel V2A	25	490 585 
Angle bracket stainless steel V2A	25	490 586
Fixing bush aluminium , for GRP \varnothing 16 mm with hexagonal screw M10 x 16 stainless steel V2A	25	490 582

Mounting plate and angle bracket





Mounting plate with bolt for mounting on walls and metal sheets.

Specification	PU	Ord. no.
Mounting plate with bolt \varnothing 10 mm stainless steel V2A / 60 mm	25	490 584 
Multi-clamp steel, hot galvanized (\varnothing 10 / \varnothing 16 mm)	50	111 430 S3

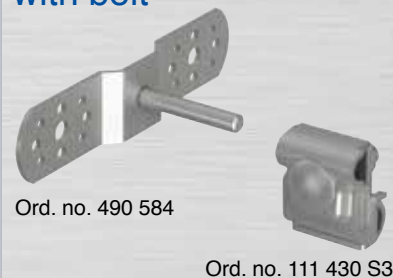
Mounting plate with bolt



Terminal clamp, heavy-duty type for mounting on steel constructions or railings, with fixing bush **aluminium**, for GRP \varnothing 16 mm.

Specification	Fit	PU	Ord. no.
Steel, hot galvanized	up to 19 mm	25	490 591
Steel, hot galvanized	19 - 36 mm	25	490 592
Steel, hot galvanized	36 - 52 mm	25	490 593
Stainless steel V2A	up to 19 mm	25	490 591 S 
Stainless steel V2A	19 - 36 mm	25	490 592 S
Stainless steel V2A	36 - 52 mm	25	490 593 S
Angle bracket stainless steel V2A , for terminal clamp, with hexagonal screw, nuts and spring lock washer		25	490 594 

Terminal clamp, heavy-duty type

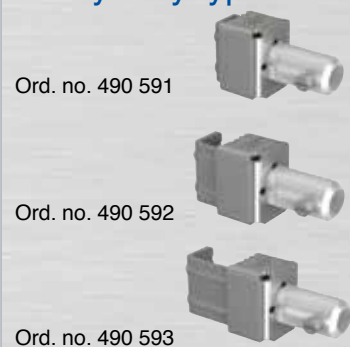

Pipe clamp for mounting on pipes or railings with fixing bush **aluminium**, for GRP \varnothing 16 mm.

Specification	Fit	Fit in inch	PU	Ord. no.
Pipe clamp stainless steel V2A with fixing screws in stainless steel V2A	\varnothing 42.4-60.3 mm	1 1/4" - 2"	20	490 587 
	\varnothing 42.4-88.9 mm	1 1/4" - 3"	20	490 587 S
Pipe clamp steel, hot galvanized with fixing screws in stainless steel V2A	\varnothing 42.4-60.3 mm	1 1/4" - 2"	20	490 588
	\varnothing 42.4-88.9 mm	1 1/4" - 3"	20	490 588 S

Pipe clamp

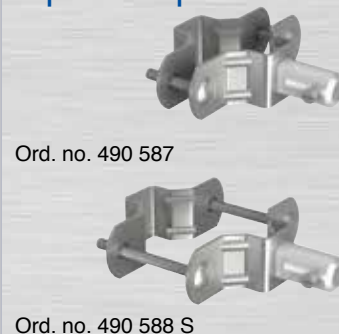

Pipe clamp for mounting on pipes up to \varnothing 300 mm with fixing bush **aluminium** for GRP \varnothing 16 mm.

Specification	Pipe- \varnothing	PU	Ord. no.
Pipe clamp with tensioning strap stainless steel V2A	max. \varnothing 300 mm	10	490 589 
Pipe clamp without tensioning strap stainless steel V2A	--	20	490 590
Tensioning strap stainless steel V2A , 22 x 0.4 mm	--	25 m	913 825
	--	50 m	913 831

Tape pipe clamp



Note: For sheet metal chimneys, use an intermediate plate (e.g.: a piece of VA-sheet)



Conductor support



Order no. 624 010



Order no. 624 020

Conductor support

Conductor support, to increase the height of the HVC-conductor on flat roofs. Incl. concrete base, H-shaped 7.5 kg, support plate and plastic conductor holder ø 28 mm.

Specification	Conductor height	PU	Order no.
Conductor support GRP ø 16 mm (SET)	300 mm	1	624 010
Conductor support GRP ø 16 mm (SET)	400 mm	1	624 011

Conductor support, to increase the height of the HVC-conductor on flat roofs. Incl. concrete base 16kg with JP-wedge technology, support plate & plastic conductor holder ø 28 mm.

Specification	Conductor height	PU	Order no.
Conductor support GRP ø 16 mm (SET)	500 mm	1	624 020
Conductor support GRP ø 16 mm (SET)	600 mm	1	624 021
Conductor support GRP ø 16 mm (SET)	700 mm	1	624 022

Application examples:

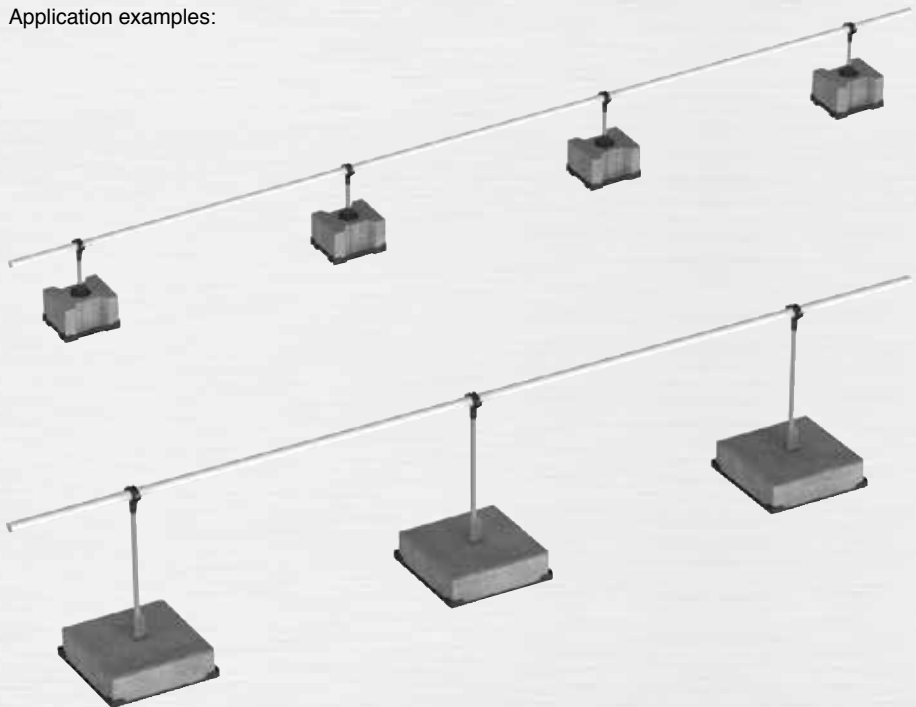



Mounting clamps

Mounting plate and angle bracket, to mount the HVC-conductor \varnothing 28 mm on walls and metal sheets.

Specification	HVC conductor fastener	PU	Order no.
Mounting plate stainless steel V2A	Plastic	25	614 010
Angle bracket stainless steel V2A	Plastic	25	614 011
Mounting plate stainless steel V2A	Stainless steel V2A	25	612 010 
Angle bracket stainless steel V2A	Stainless steel V2A	25	612 011



Order no. 614 010

Order no. 614 011

Terminal clamp, heavy-duty type, to mount the HVC-conductor to steel constructions or railings with fixing bush, [aluminium](#), and fastener, [stainless steel V2A](#) \varnothing 28 mm.

Specification	Clamping area	Fit	PU	Order no.
Steel/hot galvanized	up to 19 mm	\varnothing 28 mm	25	613 020
Steel/hot galvanized	19 - 36 mm	\varnothing 28 mm	25	613 021
Steel/hot galvanized	36 - 52 mm	\varnothing 28 mm	20	613 022
Stainless steel V2A	up to 19 mm	\varnothing 28 mm	25	612 020 
Stainless steel V2A	19 - 36 mm	\varnothing 28 mm	25	612 021
Stainless steel V2A	36 - 52 mm	\varnothing 28 mm	20	612 022



Order no. 612 021

Pipe clamp, to mount the HVC-conductor on pipes or railings with fixing bush, aluminium, and fastener, [stainless steel V2A](#) \varnothing 28 mm.

Specification	Fit	Pipe- \varnothing	PU	Order no.
Pipe clamp stainless steel V2A	\varnothing 42.4 - 60.3 mm	1 1/4" - 2"	20	612 030 
with mounting screw V2A	\varnothing 42.4 - 88.9 mm	1 1/4" - 3"	20	612 031
Pipe clam Steel/hot galvanized	\varnothing 42.4 - 60.3 mm	1 1/4" - 2"	20	613 030
with mounting screw V2A	\varnothing 42.4 - 88.9 mm	1 1/4" - 3"	20	613 031

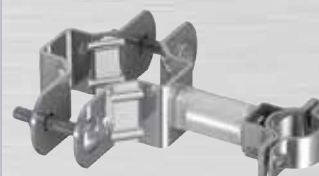

Order no. 612 030

Tape pipe clamp, to mount the HVC-conductor on pipes up to 300 mm with fixing bush, aluminium, and fastener, [stainless steel V2A](#) \varnothing 28 mm.

Specification	Pipe- \varnothing	PU	Order no.
Tape pipe clamp with tensioning strap stainless steel V2A	up to \varnothing 300 mm	10	612 041 
Tape pipe clamp without tensioning strap stainless st. V2A	-	20	612 040
Tensioning strap stainless steel V2A , 22 x 0.4 mm	-	25 m	913 825
Tensioning strap stainless steel V2A , 22 x 0.4 mm	-	50 m	913 831



Order no. 612 040



Order no. 612 041



Equipotential bonding clamp



Order no. 612 051

Equipotential bonding clamp

Equipotential bonding clamp,
with self-sealing and bonding plate for HVC-conductor

Specification	Fit	PU	Order no.
Stainless steel V2A	Square profile 9 mm	1	612 050
Stainless steel V2A	6 mm ² (ø 2.8 mm) - 50 mm ² (ø 8 mm)	1	612 051

Anwendung:

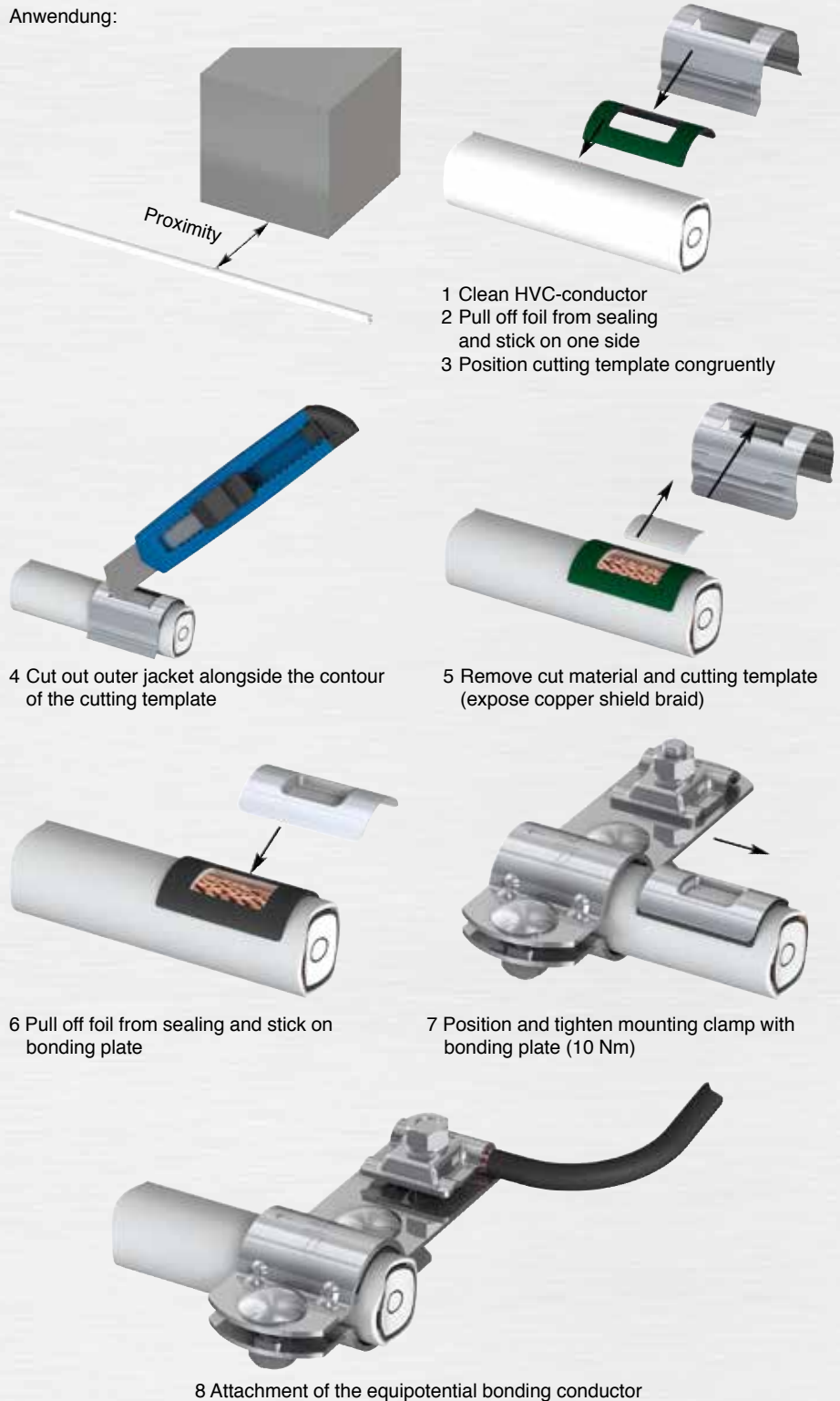

Cutting template



Order no. 640 050

Cutting template, (self-retaining) for uncovering the contact surface to install the equipotential bonding clamp to the HVC-conductor.

Specification	PU	Order no.
Stainless steel V2A	1	640 050



Accessories

Attention sign, "Attention Insulated lightning protection" / "Achtung Isolierter Blitzschutz"

Specification	Language	Fit	PU	Order no.
Aluminium with adhesive label	German	2 x ø 6.5 mm Hole spacing 125 mm	1	640 000
Aluminium with adhesive label	English	2 x ø 6.5 mm Hole spacing 125 mm	1	640 001
Adhesive label	German	95 mm x 55 mm	1	640 002
Adhesive label	English	95 mm x 55 mm	1	640 003

Attention sign, "Attention Equipotential bonding" / "Achtung Potentialausgleich"

Specification	Language	Fit	PU	Order no.
Aluminium with adhesive label	German	2 x ø 6.5 mm Hole spacing 125 mm	1	640 004
Aluminium with adhesive label	English	2 x ø 6.5 mm Hole spacing 125 mm	1	640 005
Adhesive label	German	95 mm x 55 mm	1	640 006
Adhesive label	English	95 mm x 55 mm	1	640 007

Terminal plate, for exterior air termination installation of the HVC-conductor. Up to 4 contact connections are possible.

Specification	Fit	PU	Order no.
Stainless steel V2A	ø 10.5 mm	1	632 400

Application example:



Terminal plate order no. 632 400 + head-unit order no. 601 100 (on page 144)

Cable tie, UV-resistant and weatherproof

Specification	Length	PU	Order no.
Plastic black (100 pieces)	7.6 x 560 mm	100	640 010

Cover cap, to prevent water and dirt entering during transport.

Specification	PU	Order no.
Plastic blue	10	640 020

Cleaning liquid, to clean the HVC-conductor before mounting the equipotential bonding clamp or before attaching the head-unit or base-unit.

Specification	PU	Order no.
Cleaning liquid 1 litre (delivery only in Germany and Austria possible)	1	111 645

Accessories



Order no. 640 000



Order no. 640 003



Order no. 640 005



Order no. 640 006



Order no. 632 400



Order no. 640 020



Peeling tool



Order no. 600 502



Order no. 600 505

Order no. 600 501



Order no. 600 520



Order no. 600 510



Order no. 600 530



Order no. 600 540



Order no. 600 550

Installation tools

Peeling tool, for uncovering the internal conductor of the HVC-conductor.

Specification		PU	Order no.
Peeling tool	Completely with handle and peeling head	1	600 502
Peeling tool head	Matching for the handle piece or adapter	1	600 501
Substitute blades	For the peeling tool head	1	600 503
Peeling tool	To be used with a cordless screwdriver, completely with adapter and peeling tool head	1	600 505
Adapter	For the use of the peeling head with a cordless screwdriver	1	600 504

Shear for conductor, to cut the HVC-conductor with ratchet mechanism

Specification	Fit	PU	Order no.
Shear for conductor	ø 28 mm	1	600 520

Stripping knife, to remove the outer jacket of the HVC-conductor.

Specification	PU	Order no.
Stripping knife	1	600 510

Shear for shield braid,
to cut the shield braid of the HVC conductor.

Specification	PU	Order no.
Shear for shield braid	1	600 530

Torque wrench, to mount the head-unit or base-unit

Specification	Adjustable	Bits	PU	Order no.
Torque wrench	torque 2 - 6 Nm	hex 3 mm	1	600 540

Unwinder for reel, to unwind the HVC-conductor.

Specification	PU	Order no.
To unwind 50 m and 100 m reels Suitable for a reel width up to 520 mm	1	600 550



Surge protection

Power supply, photovoltaic systems,
measurement and control technology,
information technology





Lightning current arrester (J.P. patent), type 1 multipole / mains system compliant

P-BM



Ord. no. 306 050

P-BM; (class I)/LPZ 0_A-LPZ 1

High energy, leakage current free, encapsulated, non-exhausting spark gap.
Therefore, no need to keep a safety distance to electrical installations.

Type		System	Ord. no.
P-BM 3	3-pole	TN-C	306 050
P-BM 4	4-pole	TN-S	306 051
P-BM 3+1	3+1-pole	TT	306 052

Technical data			
Type	P-BM 3	P-BM 4	P-BM 3+1
Mains system	TN-C	TN-S	TT
Lightning impulse current (10/350 μs) /total I _{imp}		100 kA	
Nominal discharge current (8/20 μs) /total I _n		100 kA	
Follow current interrupting rating I _{fi}		2 kA	
Max. backup fuse		250 A gL/gG	
Max. continuous operating voltage U _c		255 V~	
Voltage protection level U _p		< 4 kV	
Dimensions		4 mods.	
Response time t _A		< 100 ns	
Cross section for connection		min. 6 mm ² single-core / finely-stranded max. 50 mm ² stranded / 35 mm ² finely-stranded	

P-BM 230



Ord. no. 306 100

Single pole - P-BM 230 and P-N/PE B; (class I)/LPZ 0_A-LPZ 1

High energy, leakage current free, encapsulated, non-exhausting spark gap.
Therefore, no need to keep a safety distance to electrical installations.

Type		System	Ord. no.
P-BM 230	1-pole		306 100
P-N/PE B	1-pole	TT	306 101

Technical data			
Type	P-BM 230	P - N/PE B	
Mains system		TT	
Lightning impulse current (10/350 μs) /total I _{imp}	35 kA	100 kA	
Nominal discharge current (8/20 μs) /total I _n	35 kA	100 kA	
Follow current interrupting rating I _{fi}	2,0 kA	100 A	
Max. backup fuse	250 A gL/gG	---	
Max. continuous operating voltage U _c		255 V~	
Voltage protection level U _p		< 4 kV	
Dimensions		1 mod.	
Response time t _A		< 100 ns	
Cross section for connection		min. 6 mm ² single-core / finely-stranded max. 50 mm ² stranded / 35 mm ² finely-stranded	

P-N/PE B



Ord. no. 306 101

Combined lightning current and surge arrester, type 1+2

leakage-current free; multipole / mains system compliant

- Benefits:**
- Leakage-current free due to series connection of gas discharge tube and varistor.
 - Safe fixation and contact ensured by module locking mechanism.
 - P-HMS 280 G having 12.5 kA (10/350 μ s) /pole and 50 kA (10/350 μ s) 4-pole.
 - Max. backup fuse 160 A gL/gG.
 - Optimal price/performance ratio.
 - Min. cross section for connection 4 mm²

P-HMS 280 (Fm) G; (class I+II)/LPZ 0_A-LPZ 2

Combined lightning current and surge arrester, pluggable

Type	System	Ord. no.
P-HMS 280 G 2	2-pole	TN 327 220
P-HMS 280 G 1+1	1+1-pole	TT 327 210
P-HMS 280 G 3	3-pole	TN-C 327 230
P-HMS 280 G 4	4-pole	TN-S 327 250
P-HMS 280 G 3+1	3+1-pole	TT 327 240

Combined lightning current and surge arrester, pluggable

Type with remote signalling contact (Fm)	System	Ord. no.
P-HMS 280 Fm G 2	2-pole	TN 327 222
P-HMS 280 Fm G 1+1	1+1-pole	TT 327 212
P-HMS 280 Fm G 3	3-pole	TN-C 327 232
P-HMS 280 Fm G 4	4-pole	TN-S 327 252
P-HMS 280 Fm G 3+1	3+1-pole	TT 327 242

Technical data

Type P-HMS 280 (Fm) G	2-pole	1+1-pole	3-pole	4-pole	3+1-pole
Mains system	TN	TT	TN-C	TN-S	TT
Dimensions	2 mods.	2 mods.	3 mods.	4 mods.	4 mods.
Nominal discharge current (8/20 μ s) /total I _n	50 kA	30 kA	75 kA	100 kA	100 kA
Max. discharge current (8/20 μ s) /total I _{max}	80 kA	60 kA	120 kA	150 kA	120 kA
Lightning impulse current (10/350)/total I_{imp}	25 kA	20 kA	37,5 kA	50 kA	50 kA
Voltage protection level U _p	< 1,5 kV				
Response time t _A	< 100 ns				
Max. backup fuse	160 A gL/gG				
Max. continuous operating voltage U _c	255 V~				
Cross section for connection	min. 4 mm ² single-core/ finely-stranded max. 50 mm ² stranded / 35 mm ² finely-stranded				

P-HMS 280 G



Ord. no. 327 230



Ord. no. 327 242





Combined lightning current and surge arrester, type 1+2 e.g. for residential or office buildings

- Benefits:**
- Safe fixation and contact ensured by module locking mechanism.
 - P-HMS 280 R having 12.5 kA (10/350 μ s) /pole and 50 kA (10/350 μ s) 4-pole.
 - Max. backup fuse 160 A gL/gG.
 - Optimal price/performance ratio.
 - Min. cross section for connection 4 mm²

Multipole/mains system compliant - P-HMS 280 (Fm) R; (class I+II)/LPZ 0_A-LPZ 2

Combined lightning current and surge arrester, pluggable

Type		System	Ord. no.
P-HMS 280 R 2	2-pole	TN	317 220
P-HMS 280 R 1+1	1+1-pole	TT	317 210
P-HMS 280 R 3	3-pole	TN-C	317 230
P-HMS 280 R 4	4-pole	TN-S	317 250
P-HMS 280 R 3+1	3+1-pole	TT	317 240

Combined lightning current and surge arrester, pluggable

Type with remote signalling contact (Fm)		System	Ord. no.
P-HMS 280 Fm R 2	2-pole	TN	317 222
P-HMS 280 Fm R 1+1	1+1-pole	TT	317 212
P-HMS 280 Fm R 3	3-pole	TN-C	317 232
P-HMS 280 Fm R 4	4-pole	TN-S	317 252
P-HMS 280 Fm R 3+1	3+1-pole	TT	317 242

Technical data

Type P-HMS 280 (Fm) R	2-pole	1+1-pole	3-pole	4-pole	3+1-pole
Mains system	TN	TT	TN-C	TN-S	TT
Dimensions	2 mods.	2 mods.	3 mods.	4 mods.	4 mods.
Nominal discharge current (8/20 μ s) /total I _n	60 kA	30 kA	90 kA	120 kA	100 kA
Max. discharge current (8/20 μ s) /total I _{max}	100 kA	60 kA	150 kA	150 kA	120 kA
Lightning impulse current (10/350) /total I_{imp}	25 kA	20 kA	37,5 kA	50 kA	50 kA
Voltage protection level U _p	< 1,3 kV	< 1,5 kV	< 1,3 kV	< 1,3 kV	< 1,5 kV
Response time t _A	< 25 ns	< 100 ns	< 25 ns	< 25 ns	< 100 ns
Max. backup fuse	160 A gL/gG				
Max. continuous operating voltage U _c	L-N 280 V~ / N-PE 255 V~				
Cross section for connection	min. 4 mm ² single-core/ finely-stranded max. 50 mm ² stranded / 35 mm ² finely-stranded				

Single pole - P-HMS 280 (Fm) R and P-N/PE BC R; (class I+II)/LPZ 0_A-LPZ 2

Combined lightning current and surge arrester, pluggable ,

Type with or without remote signalling contact (Fm)		Ord. no.
P-HMS 280 R	1-pole	317 200
P-HMS 280 Fm R	1-pole, with remote signalling contact	317 202

Combined lightning current and surge arrester for TT-system

Type		System	Ord. no.
P-N/PE BC R	1-pole	TT	317 260
P-N/PE BC R 50	1-pole	TT	317 262

Technical data

Type	P-HMS 280 (Fm) R	P-N/PE BC R	P-N/PE BC R 50
Mains system		TT	TT
Dimensions	1 mod.	1 mod.	1 mod.
Nominal discharge current (8/20 μ s) I _n	30 kA	30 kA	100 kA
Max. discharge current (8/20 μ s) I _{max}	50 kA	60 kA	120 kA
Lightning impulse current (10/350) I_{imp}	12.5 kA	20 kA	50 kA
Voltage protection level U _p	< 1,3 kV	< 1,5 kV	< 1,5 kV
Max. backup fuse	160 A gL/gG	---	---
Max. continuous operating voltage U _c	280 V~	255 V~	255 V~
Cross section for connection	min. 4 mm ² single-core/ finely-stranded max. 50 mm ² stranded / 35 mm ² finely-stranded		

P-HMS 280 R



Ord. no. 317 230



Ord. no. 317 242

P-HMS 280 R



Ord. no. 317 200

P-N/PE BC R



Ord. no. 317 260

Combined lightning current and surge arrester, type 1+2 e.g. for residential or office buildings

Multipole/mains system compliant - P-HMS 280 (Fm);
(class I+II)/LPZ 0_A-LPZ 2

Combined lightning current and surge arrester, pluggable		
Type		System
P-HMS 280 2	2-pole	TN
P-HMS 280 1+1	1+1-pole	TT
P-HMS 280 3	3-pole	TN-C
P-HMS 280 4	4-pole	TN-S
P-HMS 280 3+1	3+1-pole	TT

Combined lightning current and surge arrester, pluggable		
Type with remote signalling contact (Fm)		System
P-HMS 280 Fm 2	2-pole	TN
P-HMS 280 Fm 1+1	1+1-pole	TT
P-HMS 280 Fm 3	3-pole	TN-C
P-HMS 280 Fm 4	4-pole	TN-S
P-HMS 280 Fm 3+1	3+1-pole	TT

Technical data					
Type P-HMS 280 (Fm)	2-pole	1+1-pole	3-pole	4-pole	3+1-pole
Mains system	TN	TT	TN-C	TN-S	TT
Dimensions	2 mods.	2 mods.	3 mods.	4 mods.	4 mods.
Nominal discharge current (8/20 μs) /total I _n	60 kA	30 kA	90 kA	100 kA	30 kA
Max. discharge current (8/20 μs) /total I _{max}	100 kA	60 kA	150 kA	150 kA	60 kA
Lightning impulse current (10/350) /total I _{imp}	16 kA	16 kA	24 kA	32 kA	20 kA
Voltage protection level U _p	< 1,3 kV	< 1,5 kV	< 1,3 kV	< 1,3 kV	< 1,5 kV
Response time t _A	< 25 ns	< 100 ns	< 25 ns	< 25 ns	< 100 ns
Max. backup fuse	125 A gL/gG				
Max. continuous operating voltage U _c	L-N 280 V~ / N-PE 255 V~				
Cross section for connection	min. 6 mm ² single-core/ finely-stranded max. 50 mm ² stranded / 35 mm ² finely-stranded				

Single pole - P-HMS 280 (Fm) and P-N/PE B+C S;

(class I+II)/LPZ 0A-LPZ 2

Combined lightning current and surge arrester, pluggable ,		
Type with or without remote signalling contact (Fm)		Ord. no.
P-HMS 280	1-pole	307 200
P-HMS 280 Fm	1-pole, with remote signalling contact	307 202

Combined lightning current and surge arrester for TT-system		
Type		System
P-N/PE B+C S	1-pole	TT

Technical data		
Type	P-HMS 280 (Fm)	P-N/PE B+C S
Mains system		TT
Dimensions	1 mod.	1 mod.
Nominal discharge current (8/20 μs) I _n	30 kA	30 kA
Max. discharge current (8/20 μs) I _{max}	50 kA	60 kA
Lightning impulse current (10/350) I _{imp}	8 kA	20 kA
Voltage protection level U _p	< 1,3 kV	< 1,5 kV
Max. backup fuse	125 A gL/gG	---
Max. continuous operating voltage U _c	280 V~	255 V~
Cross section for connection	min. 6 mm ² single-core/ finely-stranded max. 50 mm ² stranded / 35 mm ² finely-stranded	

P-HMS 280



Ord. no. 307 230



Ord. no. 307 242

P-HMS 280



Ord. no. 307 200

P-N/PE B+C S



Ord. no. 307 260



High energy combined lightning current and surge arrester *max*, type 1+2

multipole / mains system compliant e.g. for industrial plants

- Benefits:**
- Safe fixation and contact ensured by module locking mechanism.
 - P-HMS 280 *max* having 25 kA (10/350 μ s) /pole and 100 kA (10/350 μ s) 4-pole.
 - Max. backup fuse 250 A gL/gG.
 - Optimal price/performance ratio.
 - Min. cross section for connection 4 mm²

P-HMS 280 *max*



Ord. no. 317 235



Ord. no. 317 247

P-HMS 280 (Fm) *max*, (class I+II)/LPZ 0_A-LPZ 2

Combined lightning current and surge arrester, pluggable

Type		System	Ord. no.
P-HMS 280 <i>max</i> 3	3-pole	TN-C	317 235
P-HMS 280 <i>max</i> 4	4-pole	TN-S	317 255
P-HMS 280 <i>max</i> 3+1	3+1-pole	TT	317 245

Combined lightning current and surge arrester, pluggable

Type with remote signalling contact (Fm)		System	Ord. no.
P-HMS 280 Fm <i>max</i> 3	3-pole	TN-C	317 237
P-HMS 280 Fm <i>max</i> 4	4-pole	TN-S	317 257
P-HMS 280 Fm <i>max</i> 3+1	3+1-pole	TT	317 247

Technical data

Type P-HMS 280 (Fm) <i>max</i>	3-pole	4-pole	3+1-pole
Mains system	TN-C	TN-S	TT
Dimensions	6 mods.	8 mods.	8 mods.
Nominal discharge current (8/20 μ s) /total I_n	120 kA	120 kA	75 kA
Max. discharge current (8/20 μ s) /total I_{max}	150 kA	150 kA	150 kA
Lightning impulse current (10/350)/total I_{imp}	75 kA	100 kA	100 kA
Voltage protection level U_p	< 1,3 kV	< 1,3 kV	< 1,5 kV
Response time t_A	< 25 ns	< 25 ns	< 100 ns
Max. backup fuse	250 A gL/gG		
	parallel wiring	125 A gL/gG	
	serial wiring		
Max. continuous operating voltage U_c	L-N 280 V~ / N-PE 255 V~		
Cross section for connection	min. 4 mm ² single-core/ finely-stranded max. 50 mm ² stranded / 35 mm ² finely-stranded		

Surge arrester, type 2 single pole

P-VM (S) (Fm) (R) and P-N/PE C (S) (R); (class II)/LPZ 1-LPZ 2

Surge arrester				
Type	Max. continuous operating voltage U_c	Voltage protection level U_p	Nominal discharge current I_n (8/20 μ s)	Ord. no.
P-VM 280; not pluggable	280 V~	< 1300 V	20 kA	3066
P-VMS 280 R; pluggable	280 V~	< 1300 V	20 kA	316 280
P-VMS 280; pluggable	280 V~	< 1300 V	20 kA	306 280
Surge arrester, pluggable				
Type	U_c	U_p	I_n (8/20 μ s)	Ord. no.
P-VMS 75	75 V~	< 600 V	15 kA	306 076
P-VMS 360	360 V~	< 1850 V	20 kA	306 361
P-VMS 440	440 V~	< 2000 V	20 kA	306 441
P-VMS 500	500 V~	< 2200 V	20 kA	306 501
P-VMS 600	600 V~	< 2400 V	20 kA	306 602
Surge arrester, pluggable with remote signalling contact (Fm)				
Type	U_c	U_p	I_n (8/20 μ s)	Ord. no.
P-VMS 280 Fm	280 V~	< 1300 V	20 kA	306 282
P-VMS 280 Fm R	280 V~	< 1300 V	20 kA	316 282
P-VMS 75 Fm	75 V~	< 600 V	15 kA	306 078
P-VMS 360 Fm	360 V~	< 1850 V	20 kA	306 365
P-VMS 440 Fm	440 V~	< 2000 V	20 kA	306 443
P-VMS 500 Fm	500 V~	< 2200 V	20 kA	306 503
P-VMS 600 Fm	600 V~	< 2400 V	20 kA	306 604
Surge arrester, not pluggable				
Type	U_c	U_p	I_n (8/20 μ s)	Ord. no.
P-VM 75	75 V~	< 600 V	15 kA	306 075
P-VM 360	360 V~	< 1850 V	20 kA	306 360
P-VM 500	500 V~	< 2200 V	20 kA	306 500
Surge arrester for TT-System				
Type			I_n (8/20 μ s)	Ord. no.
P-N/PE C	1-pole (not pluggable)		30 kA	306 285
P-N/PE C R	1-pole (pluggable)		30 kA	316 286
P-N/PE C S	1-pole (pluggable)		30 kA	306 286

SPDs with additional operating voltages on request.

Technical data	P-VM (S) (Fm) (R)	P-N/PE C (S) (R)
Dimensions	1 mod.	1 mod.
Max. continuous operating voltage U_c	see above	255 V~
Nominal discharge current (8/20 μ s) I_n	see above	30 kA
Max. discharge current (8/20 μ s) I_{max}	40 kA	60 kA
Voltage protection level U_p	see above	< 1,5 kV
Response time t_A	< 25 ns	< 100 ns
Max. backup fuse	125 A gL/gG	---
Cross section for connection P-VM (S) (Fm)/ P-N/PE C (S)	min. 6 mm ² single-core/ finely-stranded max. 50 mm ² stranded / 35 mm ² finely-stranded	
Cross section for connection P-VM (S) (Fm) R/ P-N/PE C (S) R	min. 4 mm ² single-core/ finely-stranded max. 50 mm ² stranded / 35 mm ² finely-stranded	

P-VMS 280 (R) (pluggable)



Ord. no. 306 280

Ord. no. 316 280

P-VM 280 (not pluggable)



Ord. no. 3066

P-N/PE C (S)



Ord. no. 306 285

Ord. no. 316 286



Surge arrester, type 2 multipole / mains system compliant

- Benefits:**
- Safe fixation and contact ensured by module locking mechanism.
 - Min. cross section for connection 4 mm²

P-VMS 280 R



Ord. no. 316 220



Ord. no. 316 224

P-VMS 280 (Fm) R; (class II)/LPZ 1-LPZ 2

Multipole surge arrester, pluggable

Type		System	Ord. no.
P-VMS 280 R 2	2-pole	TN	316 226
P-VMS 280 R 1+1	1+1-pole	TT	316 228
P-VMS 280 R 3	3-pole	TN-C	316 220
P-VMS 280 R 4	4-pole	TN-S	316 221
P-VMS 280 R 3+1	3+1-pole	TT	316 222

Multipole surge arrester, pluggable with remote signalling contact (Fm)

Type		System	Ord. no.
P-VMS 280 Fm R 2	2-pole	TN	316 227
P-VMS 280 Fm R 1+1	1+1-pole	TT	316 229
P-VMS 280 Fm R 3	3-pole	TN-C	316 223
P-VMS 280 Fm R 4	4-pole	TN-S	316 224
P-VMS 280 Fm R 3+1	3+1-pole	TT	316 225

Technical data

Type P-VMS 280 (Fm)	2-pole	1+1-pole	3-pole	4-pole	3+1-pole
Mains system	TN	TT	TN-C	TN-S	TT
Dimensions	2 mods.	2 mods.	3 mods.	4 mods.	4 mods.
Nominal discharge current (8/20 μs) /total I _n	40 kA	30 kA	60 kA	80 kA	30kA
Max. discharge current (8/20 μs) /total I _{max}	80 kA	60 kA	120 kA	150 kA	60 kA
Response time t _A	< 25 ns	< 100 ns	< 25 ns	< 25 ns	< 100 ns
Voltage protection level U _p	< 1,3 kV	< 1,5 kV	< 1,3 kV	< 1,3 kV	< 1,5 kV
Max. continuous operating voltage U _c	L-N 280 V~ / N-PE 255 V~				
Max. backup fuse	125 A gL/gG				
Cross section for connection	min. 4 mm ² single-core/ finely-stranded max. 50 mm ² stranded / 35 mm ² finely-stranded				



Surge arrester, type 2 multipole / mains system compliant

P-VMS 280 (Fm); (class II)/LPZ 1-LPZ 2

Multipole surge arrester, pluggable

Type		System	Ord. no.
P-VMS 280 2	2-pole	TN	306 226
P-VMS 280 1+1	1+1-pole	TT	306 228
P-VMS 280 3	3-pole	TN-C	306 220
P-VMS 280 4	4-pole	TN-S	306 221
P-VMS 280 3+1	3+1-pole	TT	306 222

Multipole surge arrester, pluggable with remote signalling contact (Fm)

Type		System	Ord. no.
P-VMS 280 Fm 2	2-pole	TN	306 227
P-VMS 280 Fm 1+1	1+1-pole	TT	306 229
P-VMS 280 Fm 3	3-pole	TN-C	306 223
P-VMS 280 Fm 4	4-pole	TN-S	306 224
P-VMS 280 Fm 3+1	3+1-pole	TT	306 225

Technical data

Type P-VMS 280 (Fm)	2-pole	1+1-pole	3-pole	4-pole	3+1-pole
Mains system	TN	TT	TN-C	TN-S	TT
Dimensions	2 mods.	2 mods.	3 mods.	4 mods.	4 mods.
Nominal discharge current (8/20 μs) /total I _n	40 kA	30 kA	60 kA	80 kA	30 kA
Max. discharge current (8/20 μs) /total I _{max}	80 kA	60 kA	120 kA	150 kA	60 kA
Response time t _A	< 25 ns	< 100 ns	< 25 ns	< 25 ns	< 100 ns
Max. continuous operating voltage U _c	L-N 280 V~ / N-PE 255 V~				
Voltage protection level U _p	< 1,3 kV	< 1,5 kV	< 1,3 kV	< 1,3 kV	< 1,5 kV
Max. backup fuse	125 A gL/gG				
Cross section for connection	min. 6 mm ² single-core/ finely-stranded max. 50 mm ² stranded / 35 mm ² finely-stranded				

P-VMS 280



Ord. no. 306 220



Ord. no. 306 224



P-DA 230



Ord. no. 306 460

Surge arrester type 3 fine protection

P-DA, (class III)/LPZ 2-LPZ 3

Type	I _n (8/20 μs)			Ord. no.
	L/N ⇒ PE	L ⇒ N	L+N ⇒ PE	
P-DA 230	3 kA	3 kA	5 kA	306 460
P-DA 120	2,5 kA	2,5 kA	5 kA	306 450
P-DA 60	2,5 kA	2,5 kA	5 kA	306 440
P-DA 48	1 kA	1 kA	2 kA	306 430
P-DA 24	1 kA	1 kA	2 kA	306 420

Technical data

Type P-DA	230	120	60	48	24
Dimensions	1 mod.				
Norminal voltage U _N	230 V~	120 V~	60 V~	48 V~	24 V~
Max. continuous operating voltage U _c	255 V~	150 V~	70 V~	60 V~	30 V~
Nominal discharge c. (8/20 μs) I _n	L+N ⇒ PE 5 kA	5 kA	5 kA	2 kA	2 kA
Combination wave U _{oc}	L+N ⇒ PE 10 kV	10 kV	10 kV	4 kV	4 kV
Voltage protection level U _p	L ⇒ N <1100 V	< 700 V	< 500 V	< 400 V	< 225 V
Response time t _A	L ⇒ N	< 25 ns			
Max. backup fuse	16 A gL/gG or B 16				
Cross section for connection	0,14 - 2,5 mm ²				
Remote signalling contact (Fm):					
Contact	Floating break contact (21/22)				
Switching capacity	250 V~ / 1 A				
Cross section for connection	0,08 - 1,5 mm ²				

P-DA 1 TEL



Ord. no. 206 306

Surge protective adapter and multiple socket outlet

P-DA 1, (class III)/LPZ 2-LPZ 3

Type	Ord. no.
P-DA 1 NF with integrated surge protection and mains filter	206 303
P-DA 1 TEL with integrated surge protection & analogue telephone protection (RJ-11/RJ-45 socket)	206 306
P-DA 1 TV with integrated surge protection and TV protection (IEC 75-plug/socket)	206 307

Technical data

Type P-DA	1 NF	1 TEL	1 TV
Max. continuous operating voltage U _c	255 V~		
Nominal discharge current (8/20 μs) I _n	3,0 kA	2,5 kA	
Voltage protection level U _p	L ⇒ N < 1300 V	< 1500 V	
Response time t _A	L ⇒ N	< 25 ns	
Max. backup fuse	16 A gL/gG or B 16		

P-DA 6



Ord. no. 206 300

P-DA 6, (class III)/LPZ 2-LPZ 3

Typ	Ord. no.
P-DA 6 with integrated surge protection	206 300
P-DA 6 NF with integrated surge protection and mains filter	206 301
P-DA 6 NF IS with integrated surge protection, mains filter and ISDN protection	206 304

Technical data

Type	P-DA 6	P-DA 6 NF	P-DA 6 NF IS
Max. continuous operating voltage U _c	255 V~		
Nominal discharge current (8/20 μs) I _n	6.5 kA		
Voltage protection level U _p	L ⇒ N < 1000 V	< 1000 V	
Response time t _A	< 25 ns		
Max. backup fuse	16 A gL/gG or B 16		
Max. connection load P _{max}	3680 W		
Dimensions	490 mm	570 mm	660 mm

Surge arrester, type 2+3

Specially designed for the protection of LED applications

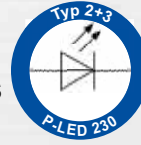

P-LED 230 1, P-LED 230 1 IP and P-LED 230 2;
(class II+III)/LPZ 1-LPZ 3

Surge arrester Type	Protection class	Ord. no.
P-LED 230 1	I	306 330
P-LED 230 1 IP	I	306 332
P-LED 230 2	II	306 331

Technical data	P-LED 230 1	P-LED 230 1 IP	P-LED 230 2
Protection class (according to EN 61140)	I	I	II
IP Code	IP 20	IP 65	IP 20
Nominal voltage U_N	230 V~		
Max. continuous operating voltage U_c	255 V~		
Nominal discharge current (8/20 μ s) I_n	10 kA		
Max. discharge current (8/20 μ s) I_{max}	20 kA		
Voltage protection level U_p	< 1,3 kV		
Combination wave U_{OC}	6 kV		
Max. back-up fuse	16 A gL/gG oder B 16 A		
Dimensions LxWxH (mm)	55x33,5x12,5		

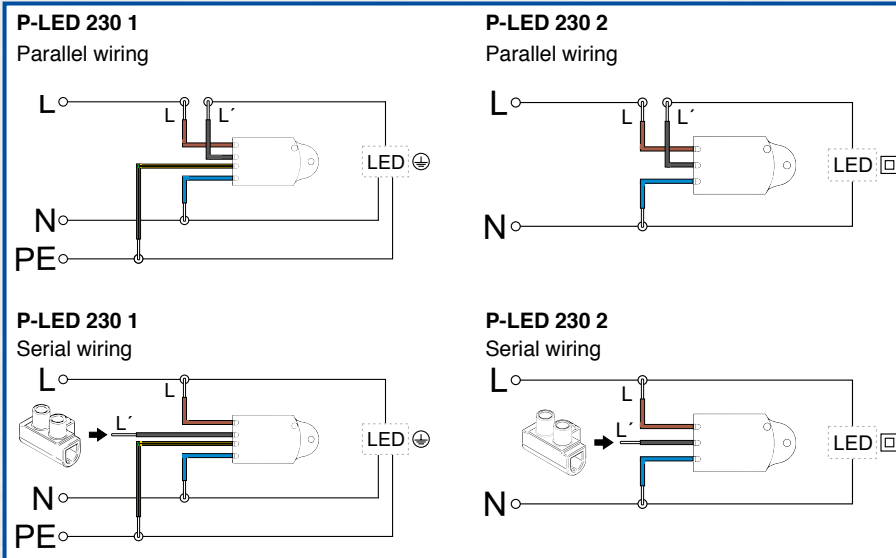

Surge protection for flush-mounted sockets, type 3

P-DA 230 UP, (class III)/LPZ 2-LPZ 3; with acoustic fault indication

Type	Description	Ord. no.
P-DA 230 UP	Surge protective adapter	206 312

Technical data	
Type	P-DA 230 UP
Max. continuous operating voltage U_c	255 V~
Nominal discharge cur. (8/20 μ s) I_{total}	L+N \Rightarrow PE: 6 kA
Voltage protection level U_p	L/N \Rightarrow PE: 1,3 kV
Response time t_A	L \Rightarrow N: < 25 ns
Max. backup fuse	16 A gL/gG or B 16
Dimensions LxWxH (mm)	45x35,5x12

P-LED 230



Ord. no. 306 330



Ord. no. 306 332

Ord. no. 306 331

P-DA 230 UP

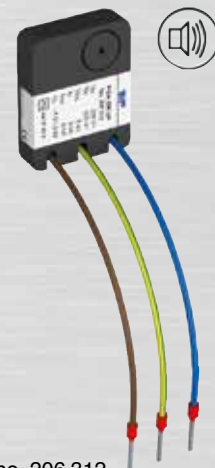

Ord. no. 206 312



Combined lightning current and surge arrester for photovoltaic systems, type 1+2

- Benefits:**
- Safe fixation and contact ensured by module locking mechanism.
 - Type 1+2 having 12.5 kA (10/350 μ s) /pole.
 - Min. cross section for connection 4 mm²

P-HYS R PV



Ord. no. 317 766



Ord. no. 317 796

Basic circuit diagram:

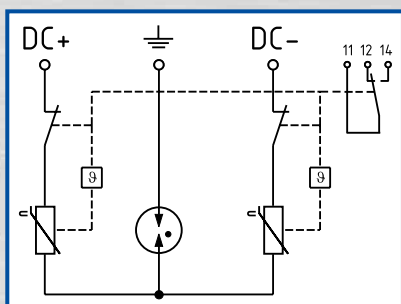

P-HYS (Fm) R PV, (class I+II)/LPZ 0_A-LPZ 2

Combined lightning current and surge arrester, pluggable

Type		Ord. no.
P-HYS 605 R PV	Y-circuit; 2+1-pole	317 762
P-HYS 805 R PV	Y-circuit; 2+1-pole	317 782
P-HYS 1005 R PV	Y-circuit; 2+1-pole	317 792

Combined lightning current and surge arrester, pluggable

Type with remote signalling contact (Fm)		Ord. no.
P-HYS 605 Fm R PV	Y-circuit; 2+1-pole	317 766
P-HYS 805 Fm R PV	Y-circuit; 2+1-pole	317 786
P-HYS 1005 Fm R PV	Y-circuit; 2+1-pole	317 796

Technical data

Type P-HYS (Fm) R PV	605	805	1005	
Dimensions	3 mods.	3 mods.	5 mods.	
Max. continuous operating voltage U_{CPV}	600 V-	800 V-	1000 V-	
Nominal discharge current (8/20 μ s) I_n	DC+ \rightarrow DC-	30 kA		
	DC+/DC- \rightarrow PE	30 kA		
	Gesamt \rightarrow PE	30 kA		
Max. discharge current (8/20 μ s) I_{max}	DC+ \rightarrow DC-	50 kA		
	DC+/DC- \rightarrow PE	50 kA		
	Gesamt \rightarrow PE	60 kA		
Lightning impulse current (10/350 μs) I_{imp}	DC+ \rightarrow DC-	12.5 kA		
	DC+/DC- \rightarrow PE	12.5 kA		
	total \rightarrow PE	20 kA	18 kA	16 kA
Voltage protection level U_p	DC+ \rightarrow DC-	< 2,4 kV	< 2,9 kV	< 3,4 kV
	DC+/DC- \rightarrow PE	< 1,8 kV	< 2,0 kV	< 2,3 kV
Response time t_A	< 100 ns			
Cross section for connection	min. 4 mm ² single-core/ finely-stranded max. 50 mm ² stranded / 35 mm ² finely-stranded			

Note: This product series is specially designed for the use in the DC side of **not earthed PV-systems** (not earthed plus or minus pole).
The maximum continuous operating voltage U_{CPV} of the device shall be selected to be always higher than the maximum open circuit voltage of the PV-generator!

Combined lightning current and surge arrester for photovoltaic systems, type 1+2

- Benefits:**
- Safe fixation and contact ensured by module locking mechanism.
 - Type 1+2 having 12.5 kA (10/350 μ s) /pole.
 - Optimal price-performance ratio.
 - Suitable for PV-systems with earthed plus or minus pole.
 - Min. cross section for connection 4 mm²

P-HYS (Fm) R PV, (class I+II)//LPZ 0_A-LPZ 2

Combined lightning current and surge arrester, pluggable

Type		Ord. no.
P-HYS 600 R PV	Y-circuit; 2+1-pole	317 761
P-HYS 800 R PV	Y-circuit; 2+1-pole	317 781
P-HYS 1000 R PV	Y-circuit; 2+1-pole	317 701

Combined lightning current and surge arrester, pluggable

Type with remote signalling contact (Fm)		Ord. no.
P-HYS 600 Fm R PV	Y-circuit; 2+1-pole	317 765
P-HYS 800 Fm R PV	Y-circuit; 2+1-pole	317 785
P-HYS 1000 Fm R PV	Y-circuit; 2+1-pole	317 705

Technical data

Type P-HYS (Fm) R PV	600	800	1000
Dimensions	3 mods.	3 mods.	6 mods.
Max. continuous operating voltage U_{CPV}	600 V-	800 V-	1000 V-
Nominal discharge current (8/20 μ s) I _n		30 kA	30 kA
Max. discharge current (8/20 μ s) I _{max}		50 kA	50 kA
Lightning impulse current (10/350 μs) I_{imp}		12.5 kA	12.5 kA
Voltage protection level U _p	(DC+ \Rightarrow DC-) < 2,4 kV (DC+/DC- \Rightarrow PE) < 2,4 kV	(DC+ \Rightarrow DC-) < 2,9 kV (DC+/DC- \Rightarrow PE) < 2,9 kV	(DC+ \Rightarrow DC-) < 3,4 kV (DC+/DC- \Rightarrow PE) < 3,4 kV
Response time t _A	< 25 ns		
Cross section for connection	min. 4 mm ² single-core/ finely-stranded max. 50 mm ² stranded / 35 mm ² finely-stranded		

Note: The product series P-HYS is specially designed for the use in the DC side of photovoltaic systems.
The maximum continuous operating voltage U_{CPV} of the device shall be selected to be always higher than the maximum open circuit voltage of the PV-generator!

P-HYS R PV



Ord. no. 317 761



Ord. no. 317 705

Basic circuit diagram:

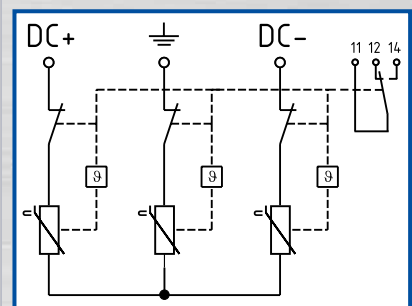



Combined lightning current and surge arrester for photovoltaic systems, type 1+2

P-HYS



Ord. no. 307 766



Ord. no. 307 796

Basic circuit diagram:

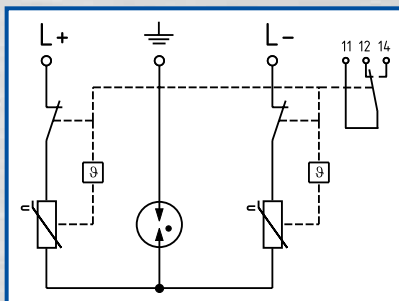

P-HYS, (class I+II)//LPZ 0_A-LPZ 2

Combined lightning current and surge arrester, pluggable

Type		Ord. no.
P-HYS 605	Y-circuit; 2+1-pole	307 762
P-HYS 805	Y-circuit; 2+1-pole	307 782
P-HYS 1005	Y-circuit; 2+1-pole	307 792

Combined lightning current and surge arrester, pluggable

Type with remote signalling contact (Fm)		Ord. no.
P-HYS 605 Fm	Y-circuit; 2+1-pole	307 766
P-HYS 805 Fm	Y-circuit; 2+1-pole	307 786
P-HYS 1005 Fm	Y-circuit; 2+1-pole	307 796

Technical data

Type P-HYS (Fm)	605	805	1005
Dimensions	3 mods.	5 mods.	5 mods.
Max. continuous operating voltage U_{CPV}	600 V-	800 V-	1000 V-
Nominal discharge current (8/20 μ s) /total I_n	30 kA		
Max. discharge current (8/20 μ s) /total I_{max}	50 kA		
Lightning impulse current (10/350 μ s) /total I_{imp}	16 kA		
Voltage protection level U_p	L+ \Rightarrow L-	< 3,8 kV	< 4,5 kV
	L+/L- \Rightarrow PE	< 2,0 kV	< 2,5 kV
Response time t_A	< 100 ns		
Cross section for connection	min. 6 mm ² single-core/ finely stranded		
	max. 50 mm ² stranded / 35 mm ² finely-stranded		

Note: This product series is specially designed for the use in the DC side of **not earthed PV-systems** (not earthed plus or minus pole).
The maximum continuous operating voltage U_{CPV} of the device shall be selected to be always higher than the maximum open circuit voltage of the PV-generator!

Surge arrester for photovoltaic systems, type 2

- Benefits:**
- Safe fixation and contact ensured by module locking mechanism.
 - Min. cross section for connection 4 mm²

P-VYS (Fm) R PV, (class II)//LPZ 1-LPZ 2

Surge arrester, pluggable

Type		Ord. no.
P-VYS 605 R PV	Y-circuit; 2+1-pole	316 762
P-VYS 805 R PV	Y-circuit; 2+1-pole	316 782
P-VYS 1005 R PV	Y-circuit; 2+1-pole	316 792

Surge arrester, pluggable with remote signalling contact (Fm)

Type		Ord. no.
P-VYS 605 Fm R PV	Y-circuit; 2+1-pole	316 766
P-VYS 805 Fm R PV	Y-circuit; 2+1-pole	316 786
P-VYS 1005 Fm R PV	Y-circuit; 2+1-pole	316 796

Technical data

Type P-VYS (Fm) R PV	605	805	1005
Dimensions	3 mods.	3 mods.	3 mods.
Max. continuous operating voltage U_{CPV}	600 V-	800 V-	1000 V-
Nominal discharge current (8/20 μ s) I_n	DC+ \Rightarrow DC-	20 kA	
	DC+/DC- \Rightarrow PE	20 kA	
	total \Rightarrow PE	30 kA	
Max. discharge current (8/20 μ s) I_{max}	DC+ \Rightarrow DC-	40 kA	
	DC+/DC- \Rightarrow PE	40 kA	
	total \Rightarrow PE	60 kA	
Voltage protection level U_p	DC+ \Rightarrow DC-	< 2,5 kV	< 3,0 kV
	DC+/DC- \Rightarrow PE	< 1,7 kV	< 1,8 kV
			< 3,5 kV
Response time t_A	< 100 ns		
Cross section for connection	min. 4 mm ² single-core/ finely stranded max. 50 mm ² stranded / 35 mm ² finely-stranded		

Note: This product series is specially designed for the use in the DC side of **not earthed PV-systems** (not earthed plus or minus pole).
The maximum continuous operating voltage U_{CPV} of the device shall be selected to be always higher than the maximum open circuit voltage of the PV-generator!

P-VYS R PV



Ord. no. 316 766

Basic circuit diagram:

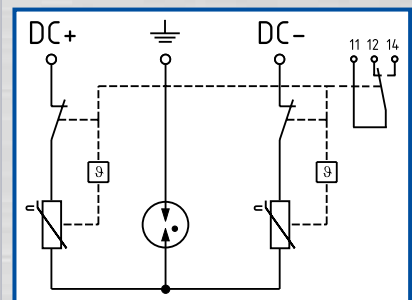



Surge arrester for photovoltaic systems, type 2

P-VYS R PV



Ord. no. 316 761

Basic circuit diagram:

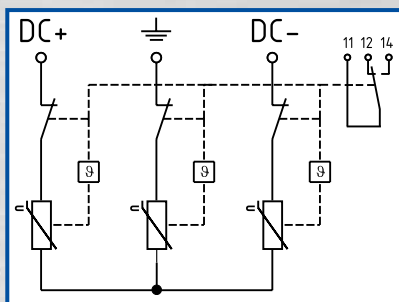

- Benefits:**
- Safe fixation and contact ensured by module locking mechanism.
 - Optimal price-performance ratio.
 - Suitable for PV-systems with earthed plus or minus pole.
 - Min. cross section for connection 4 mm²

P-VYS (Fm) R PV, (class II)/LPZ 1-LPZ 2

Surge arrester, pluggable

Type		Ord. no.
P-VYS 600 R PV	Y-circuit; 2+1-pole	316 761
P-VYS 800 R PV	Y-circuit; 2+1-pole	316 781
P-VYS 1000 R PV	Y-circuit; 2+1-pole	316 701

Surge arrester, pluggable with remote signalling contact (Fm)

Type		Ord. no.
P-VYS 600 Fm R PV	Y-circuit; 2+1-pole	316 765
P-VYS 800 Fm R PV	Y-circuit; 2+1-pole	316 785
P-VYS 1000 Fm R PV	Y-circuit; 2+1-pole	316 705

Technical data

Type P-VYS (Fm) R PV	600	800	1000
Dimensions	3 mods.	3 mods.	3 mods.
Max. continuous operating voltage U_{CPV}	600 V-	800 V-	1000 V-
Nominal discharge current (8/20 μ s) I_n	(DC+ \Rightarrow DC-)	20 kA	20 kA
	(DC+/DC- \Rightarrow PE)	20 kA	20 kA
Max. discharge current (8/20 μ s) I_{max}	(DC+ \Rightarrow DC-)	40 kA	40 kA
	(DC+/DC- \Rightarrow PE)	40 kA	40 kA
Voltage protection level U_p	(DC+ \Rightarrow DC-)	< 2,5 kV	< 3,0 kV
	(DC+/DC- \Rightarrow PE)	< 2,5 kV	< 3,0 kV
Response time t_A	< 25 ns		
Cross section for connection	min. 4 mm ² single-core/ finely stranded max. 50 mm ² stranded / 35 mm ² finely-stranded		

Note: The product series P-VYS is specially designed for the use in the DC side of photovoltaic systems.
The maximum continuous operating voltage U_{CPV} of the device shall be selected to be always higher than the maximum open circuit voltage of the PV-generator!



Surge arrester for photovoltaic systems, type 2

P-VYS, (class II)//LPZ 1-LPZ 2

Surge arrester, pluggable

Type		Ord. no.
P-VYS 605	Y-circuit; 2+1-pole	306 762
P-VYS 805	Y-circuit; 2+1-pole	306 782
P-VYS 1005	Y-circuit; 2+1-pole	306 792

Surge arrester, pluggable with remote signalling contact (Fm)

Type		Ord. no.
P-VYS 605 Fm	Y-circuit; 2+1-pole	306 766
P-VYS 805 Fm	Y-circuit; 2+1-pole	306 786
P-VYS 1005 Fm	Y-circuit; 2+1-pole	306 796

Technical data

Type P-VYS (Fm)	605	805	1005	
Dimensions	3 mods.	3 mods.	3 mods.	
Max. continuous operating voltage U_{CPV}	600 V-	800 V-	1000 V-	
Nominal discharge current (8/20 μ s) /total I_n	20 kA			
Max. discharge current (8/20 μ s) /total I_{max}	40 kA			
Voltage protection level U_p	L+ \Rightarrow L-	< 2,4 kV	< 3,3 kV	< 3,8 kV
	L+/L- \Rightarrow PE	< 1,5 kV	< 1,75 kV	< 2,0 kV
Response time t_A	< 100 ns			
Cross section for connection	min. 6 mm ² single-core/ finely stranded max. 50 mm ² stranded / 35 mm ² finely stranded			

Note: This product series is specially designed for the use in the DC side of **not earthed PV-systems** (not earthed plus or minus pole).
The maximum continuous operating voltage U_{CPV} of the device shall be selected to be always higher than the maximum open circuit voltage of the PV-generator!

P-VYS



Ord. no. 306 766

Basic circuit diagram:

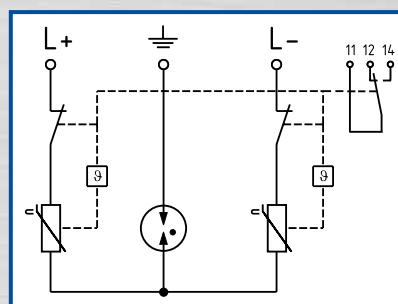



Surge arrester for high-frequency signal circuits

P-1(2)SQ HF, LPZ 0 - LPZ 3

Differential mode protection for LPZ 0 - 3		U_N	Ord. no.
P-1 SQ 5 HF	1 signal circuit	5 V-	230 105
P-1 SQ 24 HF	1 signal circuit	24 V-	230 124
P-2 SQ 5 HF	2 signal circuits	5 V-	230 605
P-2 SQ 24 HF	2 signal circuits	24 V-	230 624

Technical data		
Type P-1 (2)	SQ 5 HF	SQ 24 HF
Norminal voltage U_N	5 V-	24 V-
Max. continuous operating voltage U_C	7 V- 4,9 V~	30 V- 21,2 V~
C3 Voltage protection level at 1 kV/ μ s U_p	line-line < 12 V line-PE < 550 V	< 40 V
C2 Voltage protection level at 10 kA U_p	line-line < 55 V line-PE < 800 V	< 85 V
C2 Voltage protection level at 5 kA U_p	line-line < 35 V line-PE < 650 V	< 67 V
Nominal current		0,8 A
C2 Nominal discharge current (8/20 μ s) I_n	per pair	10 kA
D1 Lightning impulse current (10/350 μ s) I_{imp}	per pair	5 kA
Response time t_A		1 ns
Line resistance		1,0 Ω
Cut-off frequency f_g		120 MHz
Cross section for connection		0,14 - 2,5 mm ²
Test category according to EN 61643-21		A2, C1, C2, C3, D1
Housing material		Thermoplast, UL 94 V-0, colour orange

Note: Surge arrester for earth-potential free signal circuits

P-1 SQ 5 HF



Ord. no. 230 105

P-2 SQ 24 HF



Ord. no. 230 624

Basic circuit diagram P-1 SQ HF:

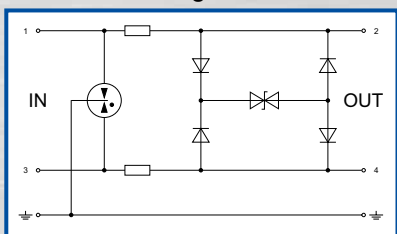

Basic circuit diagram P-2 SQ HF:

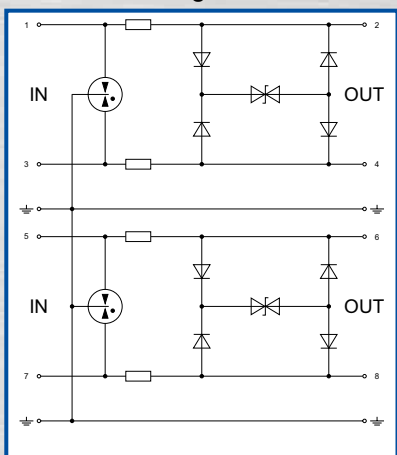

Design:

Signal circuit

P-1 1 signal circuit

P-2 2 signal circuit

Basic protection (LPZ 0 - LPZ 1)

P- S signal circuit basic protection

Basic protection + fine protection for (LPZ 0 - LPZ 3)

P- SQ differential mode protection line/line

P- SQL differential and common mode protection line/line + line/PE

High-frequency

P- HF with high cut-off frequency

General:

P- E Surge arrester with DIN rail earthing

SPD earthed by snapping onto 35 mm DIN rail (according to EN 60715) on request.



Surge arrester for information, measurement and control technology

P-1(2) SQ, LPZ 0 - LPZ 3

Type for analogue telephone lines		U_N	Ord. no.
P-1 SQ 110	1 signal circuit	110 V~	220 194
P-2 SQ 110	2 signal circuits	110 V~	220 694
Differential mode protection for LPZ 0 - 3		U_N	Ord. no.
P-1 SQ 5	1 signal circuit	5 V-	220 105
P-1 SQ 12	1 signal circuit	12 V-	220 112
P-1 SQ 24	1 signal circuit	24 V-	220 124
P-1 SQ 48	1 signal circuit	48 V-	220 148
P-1 SQ 60	1 signal circuit	60 V-	220 160
P-2 SQ 5	2 signal circuits	5 V-	220 605
P-2 SQ 12	2 signal circuits	12 V-	220 612
P-2 SQ 24	2 signal circuits	24 V-	220 624
P-2 SQ 48	2 signal circuits	48 V-	220 648
P-2 SQ 60	2 signal circuits	60 V-	220 660

Technical data							
Type P-1 (2)		SQ 5	SQ 12	SQ 24	SQ 48	SQ 60	SQ 110
Normal voltage U_N		5 V-	12 V-	24 V-	48 V-	60 V-	110 V~
Max. continuous operating voltage U_C		6 V- 4,5 V~	15 V- 10,5 V~	28 V- 20 V~	58 V- 41 V~	70 V- 50 V~	170 V- 120 V~
C3 Voltage protection level at 1 kV/ μ s U_p	line-line	< 9 V	< 20 V	< 35 V	< 75 V	< 90 V	< 210 V
	line-PE	< 550 V					
C2 Voltage protection level at 10 kA U_p	line-line	< 15 V	< 28 V	< 45 V	< 85 V	< 105 V	< 240 V
	line-PE	< 700 V					
Nominal current							0,75 A
C2 Nominal discharge current (8/20 μ s) I_n	total						20 kA
	per line						10 kA
D1 Lightning impulse current (10/350 μ s) I_{imp}	total						5 kA
	per line						2,5 kA
Response time t_A							1 ns
Line resistance							2,2 Ω
Cut-off frequency f_g		1,2 MHz	3,2 MHz	6 MHz	9,2 MHz	12 MHz	23 MHz
Cross section for connection		0,14 - 2,5 mm ²					
Test category according to EN 61643-21		A2, C1, C2, C3, D1					
Housing material		Thermoplast, UL 94 V-0, colour orange					

Note: Surge arrester for earth-potential free signal circuits

Basic circuit diagram P-1 SQ:

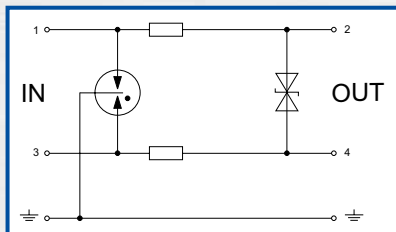

Basic circuit diagram P-2 SQ:

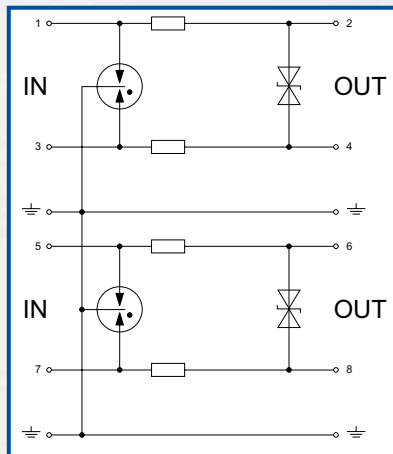

P-1 SQ 110



Ord. no. 220 194

P-2 SQ 24



Ord. no. 220 624



Surge arrester for information, measurement and control technology

P-1 S



Ord. no. 220 000

P-2 SQL 12



Ord. no. 220 712

Basic circuit diagram P-1 S

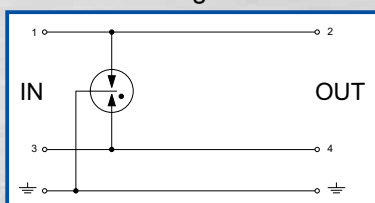

Basic circuit diagram P-2 S

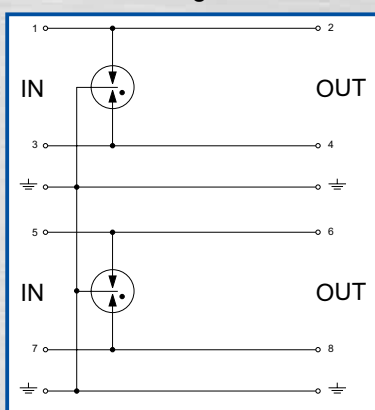

P-1(2) S, LPZ 0 - LPZ 1 and P-1(2) SQL, LPZ 0 - LPZ 3

Signal circuit - basic protection for LPZ 0 - 1		U_N	Ord. no.
P-1 S	1 signal circuit	110 V~	220 000
P-2 S	2 signal circuits	110 V~	220 500
Differential and common mode protection for LPZ 0 - 3		U_N	Ord. no.
P-1 SQL 5	1 signal circuit	5 V-	220 205
P-1 SQL 12	1 signal circuit	12 V-	220 212
P-1 SQL 24	1 signal circuit	24 V-	220 224
P-1 SQL 48	1 signal circuit	48 V-	220 248
P-1 SQL 60	1 signal circuit	60 V-	220 260
P-2 SQL 5	2 signal circuits	5 V-	220 705
P-2 SQL 12	2 signal circuits	12 V-	220 712
P-2 SQL 24	2 signal circuits	24 V-	220 724
P-2 SQL 48	2 signal circuits	48 V-	220 748
P-2 SQL 60	2 signal circuits	60 V-	220 760

Technical data

Type P-1 (2)	SQL 5	SQL 12	SQL 24	SQL 48	SQL 60	S
Normal voltage U_N	5 V-	12 V-	24 V-	48 V-	60 V-	110 V~
Max. continuous operating voltage U_C	6 V- 4,5 V~	15 V- 10,5 V~	28 V- 20 V~	58 V- 41 V~	70 V- 50 V~	180 V- 130 V~
C3 Voltage protection level at 1 kV/ μ s U_p	line-line	< 9 V	< 20 V	< 35 V	< 75 V	< 90 V
	line-PE	< 9 V	< 20 V	< 35 V	< 75 V	< 90 V
C2 Voltage protection level at 10 kA U_p	line-line	< 15 V	< 28 V	< 45 V	< 85 V	< 105 V
	line-PE	< 20 V	< 40 V	< 60 V	< 100 V	< 110 V
Nominal current	0,75 A					10 A
C2 Nominal discharge current (8/20 μ s) I_n	total	20 kA				
	per line	10 kA				
D1 Lightning impulse current (10/350 μ s) I_{imp}	total	5 kA				
	per line	2,5 kA				
Response time t_A	1 ns					100 ns
Line resistance	2,2 Ω					-
Cut-off frequency f_g	0,8 MHz	2 MHz	4 MHz	7,5 MHz	8,7 MHz	200 MHz
Cross section for connection	0,14 - 2,5 mm ²					
Test category acc. to EN 61643-21	A2, C1, C2, C3, D1					
Housing material	Thermoplast, UL 94 V-0, colour orange					

Basic circuit diagram P-1 SQL

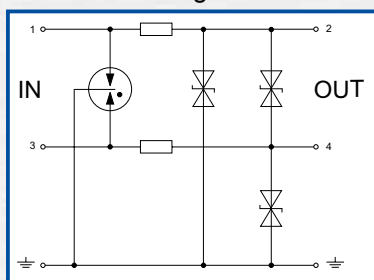

Basic circuit diagram P-2 SQL

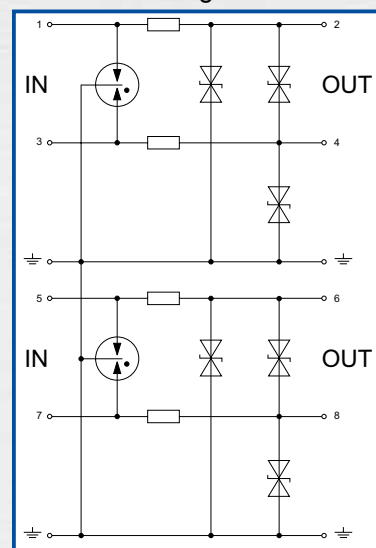



Communication and network protection

P-TK/Z-ISDN and P-TK/AN, (LPZ 0_B-LPZ 3)

Type		Ord. no.
P-TK/Z-ISDN	Including network patch cable	210 100
P-TK/AN		210 012

Technical data		
Type P-TK	/Z-ISDN	/AN
Max. continuous operating voltage U_C	14 V~ / 18 V-	120 V~ / 170 V-
Nominal discharge current (8/20 μ s) I_n	line-PE 5,0 kA	5,0 kA
Voltage protection level U_p	line-line < 60 V	\leq 300 V
Temperature range ϑ	-20°C ... +60°C	
Connection	2x RJ 45-socket	LSA Plus terminal strip
Dimensions LxWxH (mm)	80x41x24	41,5x44,5x15

Installation note:

P-TK/(Z-)ISDN: surge arrester for the protection of the data side of ISDN-devices (**S₀-Bus**)

P-TK/AN: surge arrester for analogue telephone lines

P-TK/Z-CAT 5, -CAT 6 S, (LPZ 0_B-LPZ 3)

Type		Ord. no.
P-TK/Z-CAT 5	Including network patch cable	210 110
P-TK/Z-CAT 6 S	Including network patch cable	210 130

Technical data		
Type P-TK/Z	-CAT 5	-CAT 6 S
Max. continuous operating voltage U_C	6 V~ 8.5 V-	---
Nominal current I_L	500 mA	500 mA
Nominal discharge current (8/20 μ s) I_n	line-PE 1,6 kA	1,6 kA
Voltage protection level U_p	line-line < 40 V	< 130 V
Response time t_A	< 1 ns	
Connection	2x RJ 45	
Transmission rate	1 Gbit/s	
Dimensions LxBxH (mm)	90x25x47	

P-TK/Z-ISDN



Ord. no. 210 100

P-TK/AN



Ord. no. 210 012

P-TK/Z-CAT 5



Ord. no. 210 110

P-TK/Z-CAT 6 S



Ord. no. 210 130



Communication protection in LSA-plus technology

Plug-in type surge arresters for communication systems, designed as terminal block and disconnection block with LSA-plus insulation displacement technology (soldering, screwing and strip-free connection technology).

P-LSA/GA



Ord. no. 240 351

P-LSA/KA 180



Ord. no. 240 451

P-LSA/MU



Ord. no. 240 300

P-LSA/MAD



Ord. no. 240 309

P-LSA/EB



Ord. no. 240 190

P-LSA/TL



Ord. no. 240 200

P-LSA/MB

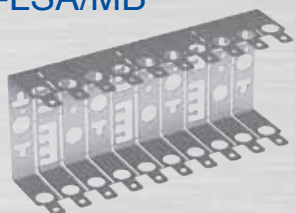

Ord. no. 240 100

Basic protection P-LSA/GA (gas discharge tube), LPZ 0_A-LPZ 1

Type	Max. continuous operating voltage U _c	PU	Ord. no.
Gas discharge tube for magazine P-LSA/MU			
P-LSA/GA 75	75 V	10	240 350
P-LSA/GA 90	90 V	10	240 351
P-LSA/GA 150	150 V	10	240 352
P-LSA/GA 230	230 V	10	240 353

System component for 2-step protection P-LSA/KA (combined lightning current and surge arrester) LPZ 1-LPZ 3

Type	Max. continuous operating voltage U _c	PU	Ord. no.
Combined arrester for direct plug-in at the disconnection block P-LSA/TL			
P-LSA/KA 180	180 V	1	240 451

System components for basic protection P-LSA/GA (gas discharge tube)

Type	PU	Ord. no.
Magazine (unequipped) for gas discharge tube P-LSA/GA		
P-LSA/MU	1	240 300
Cover for P-LSA/MU		
P-LSA/MAD	1	240 309

System components for the assembly of protective systems

Type	PU	Ord. no.
P-LSA/EB - Earthing clip	1	240 190
P-LSA/TL - Disconnection block for mounting on LSA mounting frame	1	240 200
P-LSA/AL - Terminal block for mounting on LSA mounting frame	1	240 250

System component mounting frame

Protection of 1x 2-line IT systems per LSA-plus terminal block

Type	PU	Ord. no.
P-LSA/MB- for 10 LSA-plus disconnection or terminal blocks Type P-LSA/TL or P-LSA/AL	1	240 100



Coax basic and fine protection

Basic protection

P-TK/Z-SAT, P-TK/Z-TV and P-TK/Z-BNC 75, LPZ 0_A - LPZ 1

Type	Ord. no.
P-TK/Z-SAT	210 210
P-TK/Z-TV	210 200
P-TK/Z-BNC 75	210 228

Technical data

Type P-TK/Z	-SAT	-TV	-BNC 75
Max. continuous operating voltage U_C	70 V-	60 V-	70 V-
Nominal current I_L		4 A	
Lightning impulse current (10/350 μ s) I_{imp}		2,5 kA	
Nominal discharge current (8/20 μ s) I_n		10 kA	
Voltage protection level U_p line / PE		< 600 V	
Response time t_A		< 100 ns	
Wave impedance Z		75 Ω	
Frequency range f	< 2,15 GHz	< 862 MHz	< 2,15 GHz
Connection	2x F-socket	IEC 75-plug IEC 75-socket	2x BNC-socket
Dimensions LxBxH (mm)	45x25x47	43x32x22	45x25x47
Test standard		IEC 61643-21	

Basic circuit diagram:

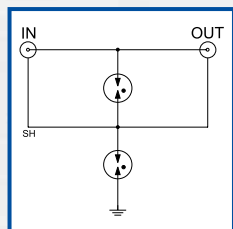

Fine protection

P-TKF/Z-SAT and P-TKF/Z-TV, LPZ 2 - LPZ 3

Type	I_n (8/20 μ s)	Ord. no.
P-TKF/Z-SAT	1,5 kA	210 212
P-TKF/Z-TV	1,5 kA	210 202

Technical data

Type P-TKF/Z	-SAT	-TV
Max. continuous operating voltage U_C	29,1 V-	65 V~-/-
Nominal current I_L	4 A	4 A
Nominal discharge current (8/20 μ s) I_n	1,5 kA	1,5 kA
Voltage protection level U_p	< 80 V	< 350 V
Response time t_A	< 1 ns	< 1 ns
Frequency range f	1 MHz-2,15 GHz	1 MHz-862 MHz
Connection	2x F-socket	IEC 75-plug IEC 75-socket
Wave impedance Z	75 Ω	75 Ω
Dimensions LxWxH (mm)	45x25x47	58.5x44x22
Test standard		IEC 61643-21

Basic circuit diagram:

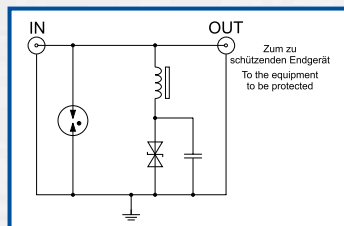

P-TK/Z-SAT



Ord. no. 210 210

P-TK/Z-TV



Ord. no. 210 200

P-TK/Z-BNC 75



Ord. no. 210 228

P-TKF/Z-SAT



Ord. no. 210 212

P-TKF/Z-TV



Ord. no. 210 202



Busbars



Ord. no. 206 062

Ord. no. 206 063

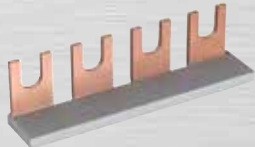

Ord. no. 206 064



Ord. no. 206 060

Earth-side bridging bar



Ord. no. 2064

Earthing terminals



Ord. no. 207 000

Distribution boards



Ord. no. 206 005

Protective spark gaps



Ord. no. 111 060



Ord. no. 111 061

Isolating spark gaps



Ord. no. 111 065

Accessories

Busbars

for multipole connection of lightning current and surge arresters.

Specification	Fit	Length	PU	Ord. no.
Copper with plastic strip	16 mm ²	1 m	1	206 060
2 mods. with integrated end cap	16 mm ²	36 mm	1	206 062
3 mods. with integrated end cap	16 mm ²	54 mm	1	206 063
4 mods. with integrated end cap	16 mm ²	72 mm	1	206 064
6 mods. with integrated end cap	16 mm ²	108 mm	1	206 065

Earth-side bridging bar, for the bridging of earthing terminals for 2, 3 or 4 single-pole lightning current and surge arresters.

Specification	PU	Ord. no.
Brass / tinned With terminal clamp 25 mm ² 2-pole to 4-pole	1	2064
Earthing terminals for the connection of an additional protective conductors up to 35 mm ²	1	207 000

Distribution board grey, degree of protection IP 65, as insulation material housing for lightning current and surge arresters.

Housing Typ	Dimensions (W x H x T)	PU	Ord. no.
KV 3 TE (3 mods.)	100 x 150 x 96 mm	1	206 010
KV 5 TE (5 mods.)	125 x 200 x 122 mm	1	206 005
KV 9 TE (9 mods.)	200 x 200 x 122 mm	1	206 004
KV 12 TE (12 mods.)	250 x 200 x 122 mm	1	206 011

Other housing dimensions on request.

Spark gaps

Protective spark gap

made of porcelain with corrosion proof connectors e.g. for roof racks

Specification	Power frequency withstand voltage (U _{aw})	PU	Ord. no.
-Discontinued product- Protective spark gap with connection bolt made of brass ø 8 mm	~ 10 kV (50 Hz)	1	111 060
Protective spark gap with connection bolt made of stainless steel V2A ø 10 mm	~ 2,5 kV (50 Hz)	1	111 061

Isolating spark gap encapsulated with plastic coating; anti-tracking.

Specification	PU	Ord. no.
Isolating Spark Gap with connection bolt made of stainless steel V2A ø 8mm	1	111 065

Technical data:		
Power frequency withstand voltage	U _{aw}	< 2,5 kV (50 Hz)
Lightning impulse sparkover voltage	U _{as100}	< 5,0 kV (1,2/50 μs)
Lightning impulse current	I _{imp}	100 kA (10/350 μs)



Spare parts

Plug-in - type	Housing colour	Ord. no.
P-HMS 280	red	207 201
P-HMS 280 Fm	red	207 203
P-HMS 360	red	207 301
P-HMS 360 Fm	red	207 303
P-HMS 440	red	207 401
P-HMS 440 Fm	red	207 403
P-HMS 280	blue	307 201
P-HMS 300 PV	blue	307 201 PV
P-HMS 280 Fm	blue	307 203
P-HMS 300 Fm PV	blue	307 203 PV
P-HMS 360	blue	307 301
P-HMS 400 PV	blue	307 301 PV
P-HMS 360 Fm	blue	307 303
P-HMS 400 Fm PV	blue	307 303 PV
P-HMS 440	blue	307 401
P-HMS 500 PV	blue	307 401 PV
P-HMS 440 Fm	blue	307 403
P-HMS 500 Fm PV	blue	307 403 PV
P-VMS 280	red	206 281
P-VMS 280 Fm	red	206 283
P-VMS 360	red	206 364
P-VMS 360 Fm	red	206 366
P-VMS 440	red	206 442
P-VMS 440 Fm	red	206 444
P-VMS 280	blue	306 281
P-VMS 300 PV	blue	306 281 PV
P-VMS 280 Fm	blue	306 283
P-VMS 300 Fm PV	blue	306 283 PV
P-VMS 360	blue	306 364
P-VMS 400	blue	306 364 PV
P-VMS 360 Fm	blue	306 366
P-VMS 400 Fm PV	blue	306 366 PV
P-VMS 440	blue	306 442
P-VMS 500 PV	blue	306 442 PV
P-VMS 440 Fm	blue	306 444
P-VMS 500 Fm PV	blue	306 444 PV
P-HMS 280 R	blue	317 201
P-HMS 300 R PV	blue	317 201 PV
P-HMS 400 R PV	blue	317 301 PV
P-HMS 280 <i>max</i>	blue	317 206
P-HMS 500 R PV	blue	317 405 PV
P-VMS 280 R	blue	316 281
P-VMS 300 R PV	blue	316 281 PV
P-VMS 360 R	blue	316 364
P-VMS 400 R PV	blue	316 364 PV
P-VMS 440 R	blue	316 442
P-VMS 500 R PV	blue	316 442 PV
P-HMS 280 G	blue	327 201

Additional spare parts on request.



Ord. no. 207 201



Ord. no. 307 201



Ord. no. 206 281



Ord. no. 306 281



Ord. no. 317 201



Ord. no. 317 206



Ord. no. 317 405 PV



Ord. no. 316 281



Important notes and explanations:

For surge protective devices, that are marked with “Fm”, the following applies:

Remote signalling contact (Fm):

Contact	Change-over contact
Switching capacity	250 V / 5,0 A~ 75 V / 0,75 A- 125 V / 0,5 A- 250 V / 0,25 A-
Cross-section for connection	0,08 - 1,5 mm ²

Diagram:

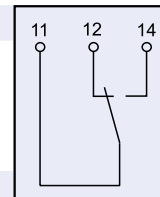

For all surge protective devices illustrated in the catalogue the following applies:

Dimensions according to DIN 43 880	17,5 mm (1 mod. = 18 mm)	
Temperature range	- 40°C ... + 80°C	
Housing material	Thermoplast UL 94 V-0	
IP Code	IP 20	
Mounting on DIN rail	35 mm according to EN 60715	
Installation tool	Screwdriver:	Slot, size 5.5 Phillips, size 2
	Function indicator	OK: GREEN or TRANSPARENT Defect: Logo “DEFECT”

Important: Defect arresters offer no protection and must be replaced!

Test standard for surge protective devices for power supply	EN 61643-11
Test standard for surge protective devices for photovoltaic systems	EN 50539-11
Test standard for surge protective devices for information technology	EN 61643-21

If specifications differ, please refer to the information supplied in the "technical data" tables for the respective device.

Important note:

The information about possible application areas for our products is intended as product-specific information only. Our technical application notes are the result of many years of experience and are made to the best of our knowledge. This information is, however, non-binding, since the different possibilities of application and individual installation conditions that our products may be subjected to, lie outside our sphere of influence. We therefore recommend that you observe the current country-specific standards and check that the products in question are suitable for the intended application.

Use and installation of the products are outside of our control and are therefore the sole responsibility of the user.



Keyword register

Air termination poles, for block foundation	136	JP-MBF BS-System	138/139
Air termination poles, for wall mounting	134	KS-connectors	71/90
Air termination poles, free-standing	132/133/135	Lightning current arresters type 1	158
Air termination rods	34/36/38-41	Multi-clamps	69
Air termination stud	42	Multi-Plus-clamps	68/79
Air termination tip	42	Niro-Clip	44-46
Bimetal clamp	82/83	Number plates	86
Bimetal Multi-clamps	69/82	Plastic conductor fastener	46
Bimetallic bush and strip	82	Plastic spacer	47
Bridging brackets	85	Plastic washers	47
Bridging braids	85	Protective spark gaps	180
Bridging cables	85	Rod holder	50
Cables	32	Roof bushing	60
Clamping jaws	71/90	Roof conductor holder	52-62
Clamping shoe	84	Roof conductor holder for ridge tiles	58/59
Combined lightning current and surge arresters type 1+2	159-162	Round wires	33
Concrete bases	34/36-37/132	Saddle clamps	78/79
Conductor	32	Screw cap conductor fasteners	46
Conductor fastener	44-46/48	Screws	118
Connection clamp	70-72	Snow guard clamps	84
Corrosion prevention tape	118	Spring lock washers	118
Cross clamps	94	Straightening tools	116/117
Cross profiled earth rod	92	Strips	32
Diagonal-cross clamps	94	Surge arrester for LED	167
Disconnecting clamps	74-77	Surge arrester for PV	168-173
Downpipe clamps	49/88	Surge arrester type 2	163-165
Driving heads	102	Surge arrester type 3	166/167
Driving steel darts	101	Surge arresters for information, measurement and control technology	174-179
Earth electrode inspection housing	87	Surge protective adapters	166
Earth lead-in rods	92	Tape conductor holder	51
Earth rods	101	Telescope air termination pole	35/135
Earthing pipe clamps	88-90	Terminal angles	72
Eath testers	120	Terminal clamps	80/81/101
Equipotential bonding	112-114	Test joint boxes	87
Expansion pieces	85	Tubular earth rod	101
Fasteners	47	Uncoiling units	116
Fixed earthing terminals	103-106	USV-clamp	94
Fixed earthing terminals with DB-approval	109/110	Vario-clamp	76-77
Gutter clamp	73	Wall bushings	105/106
HVC	144-156	Wall conductor fasteners	44-48/50/51
Inspection doors	86	Wedge connectors	100
Insulated air termination poles	122/123		
Insulated conductor	144/145		
Insulated stand-offs	124-128		
Isolating spark gap	180		



Numerical index

Ord. no.	Tested	Page	Ord. no.	Tested	Page	Ord. no.	Tested	Page	Ord. no.	Tested	Page
1010		46	1248	H	90	1343 Z	H	76/82	2084		120
1011		46	1249	H	90	1344	H	76	2090		120
1014		46	1250		41	1345	H	76	2100	H	72
1015		46	1251		41	1346	H	76	2101	H	72
1021		52	1252		42	1347	H	76	2102	H	72
1024		118	1253		42	1348 Z	H	76/82	2103	H	72
1025		118	1254		41	1349 Z	H	76/82	2104	H	72
1027		52	1254 S1		41	1354	H	94	2105	H	72
1028		52	1254 S2		41	1359	H	71/90	2106	H	72
1029		52	1254 S3		41	1360	H	71/90	2107	H	72
1031		48	1255		41	1361	H	71/90	2108	H	42/72
1032		48	1255 S2		41	1362	H	71/90	3066		163
1033		48	1257		41	1363	H	72	9105		113
1034		48	1257 S		41	1364	H	72	9106		113
1035		48	1259		41	1365		84	9108		113
1036		48	1259 S		41	1366	H	72	9110		113
1037		48	1263		78	1367	H	72	9112		113
1038		48	1264		78	1368	H	72	9114		113
1039		48	1270	H	69	1369	H	85	9115		113
1040		86	1270 S3	H	90	1370	H	85	9116		113
1041		86	1271	H	69	1371	H	85	9118		113
1042		47	1271 S	H	90	1372	H	85	9120		113
1042 S		73	1272	H	69	1373	H	85	100 008	Ik 3,5 kA	33
1043		87	1273	H	69	1374	H	85	100 010	Ik 5,5 kA	33
1043 S1		87	1273 S1	H	90	1375	H	85	100 011		33
1044		86	1274	H	69/82	1376	H	85	100 012	Ik 2,9 kA	33
1045		86	1275	H	69	1377	H	80	100 013	Ik 5,5 kA	33
1046		47	1276	H	69	1379	H	80	100 014		33
1046 S		73	1277	H	69	1380		85	100 015	Ik 2,9 kA	33
1047		47	1278	H	69/94	1381	H	72	100 018		33
1048		47	1279	H	69/94	1382	H	72	100 019		33
1049		117	1279 S	H	69/94	1383	H	72	100 020		33
1050		86	1280	H	71	1384	H	72	100 022		33
1051		82	1281		71	1385	H	72	100 028	Ik 9,8 kA	33
1052		82	1282		71	1390	H	72	100 029	Ik 9,8 kA	33
1053		82	1283	H	71	1390 S	H	72	100 029 k	Ik 9,8 kA	33
1054		86	1284		71	1395		84	100 030		32
1055		87	1285		71	1396	H	84	100 033	Ik 9,5 kA	32
1055 S1		87	1286		71	1397		84	100 034	Ik 13,7 kA	32
1056		86	1287		71	1455	H	70	100 035	Ik 18,5 kA	32
1057		86	1288	H	82	1456	H	70	100 036	Ik 23,4 kA	32
1058		86	1289	H	82	1457	H	75	100 037	Ik 7,2 kA	32
1059		86	1290 Z		83	1458	H	75	100 038	Ik 10,1 kA	32
1060		86	1292		78	1459	H	75	100 039	Ik 13,8 kA	32
1062		54	1293		78	1460	H	70	100 040	Ik 17,4 kA	32
1063		54	1295		80	1461	H	70	100 041		32
1064		54	1296	H	78	1462	H	71/90	100 042		32
1065		54	1297	H	78	1479	H	80	100 043		32
1066		54	1297 Z		83	1480	H	71	100 058		32/122
1067		54	1298	H	78	1481		71	100 112	Ik 3,9 kA	32
1068		118	1299		78	1483	H	71	100 112 k	Ik 3,9 kA	32
1069		118	1300		73	2000	H	71	100 114	Ik 3,9 kA	32
1088		56	1300 Z		73/83	2001		73	100 114 k	Ik 3,9 kA	32
1095		56	1301		73	2002	H	80	100 118	Ik 9,7 kA	32
1121		51	1302		73	2003	H	100	100 121	Ik 3,5 kA	33
1128		51	1305		73	2004	H	100	100 123		33
1132		48	1305 S		73	2005	H	100	100 225	Ik 3,5 kA	32
1137		48	1306		73	2005 S	H	100	100 336	Ik 7,4 kA	32
1142		50	1307		73	2006	H	76	100 336k	Ik 7,4 kA	32
1147		50	1307 Z		73/83	2007	H	76	100 440	Ik 11,2 kA	32
1150		46	1308		73	2008	H	94	100 540	Ik 14,1 kA	32
1151		46	1308 S		57	2008 S	H	94	100 750		38/92
1152		46	1309		57	2008 S1	H	94	101 000		38/92
1153		46	1309 S		57	2008 S2	H	94	101 002		38/92
1154		46	1310	H	84	2009	H	101	101 005		38/92
1155		46	1311		84	2010	H	101	101 200		38/92
1158		46	1312	H	84	2011	H	101	101 205		38/92
1159		46	1313	H	84	2012	H	76	101 500		38/92
1163		61	1314	H	84	2013	H	101	101 505		38/92
1167		60	1315	H	84	2014	H	76	102 000		38
1175		60	1319		93	2015	H	94	102 005		38/92
1178		51	1320		100	2015 S	H	94	102 075		92
1178 S		51	1320 S	H	100	2016	H	76	102 100		92
1180		51	1321		93	2017	H	101	102 120		92
1181		51	1321 S		93	2018	H	101	102 150		92
1182		51	1322	H	100	2020	H	101	102 200		38
1183		51	1323	H	100	2021	H	101	102 205		38/92
1184		51	1324	H	100	2025	H	101	102 206		92
1185		51	1325	H	100	2030		48	102 206 S1		92
1187		50	1326	H	100	2031	H	101	102 207		38/92
1188		50	1327	H	100	2037		51	102 208		118
1189		50	1327 S	H	100	2039		51	102 209		118
1190		50	1329	H	100	2040	H	42	102 211		92
1191		50	1330	H	74	2043	H	76	102 212		92
1192		50	1331	H	74	2044	H	76	102 213		92
1193		50	1332	H	74	2056		102	102 214		92
1194		50	1333	H	74	2057		102	102 219		32/93
1195		50	1334		78	2058		101	102 220		32/93
1196		50	1335		78	2059		101	102 233		92
1240	H	90	1336		78	2062		120	102 234		92
1241	H	90	1337	H	76	2062 S		120	102 505		32/93
1242	H	90	1339	H	76	2063		120	102 550		38
1243	H	90	1340	H	76	2063 S		120	103 100		34
1244	H	90	1341	H	76	2064		180	103 101		34/132
1245	H	90	1342	H	76	2072	H; Ik 39,0 kA	113	103 102		34/132
1246	H	90	1342 Z	H	76/82	2081		120	103 103		34/132
1247	H	90	1343	H	76	2083		120	103 104		40

The components marked with -H- are tested with 100 kA (10/350 μ s) according to EN 62561-1. Status: December 2017

I_k = short circuit current (50Hz) (1s; \leq 300 C°)



Numerical index

Ord. no.	Tested	Page	Ord. no.	Tested	Page	Ord. no.	Tested	Page	Ord. no.	Tested	Page
103 106		40	110 135		92	110 544		59	111 175		59
103 107		40	110 140		92	110 545		59	111 176		59
103 110		34/132	110 145		92	110 546		59	111 177		59
103 111		34	110 150		92	110 547		59	111 178		59
103 112		34	110 160		48	110 999		45	111 191		59
103 113		34	110 161		48	111 000		45	111 192		59
103 114		34	110 162		51	111 001		44	111 196		59
103 117		34	110 163		51	111 002		44	111 197		59
103 118		34/132	110 164		50	111 003		46	111 205		88
103 121		42	110 165		50	111 004		46	111 207		88
103 122		42	110 171		48	111 005		44	111 210		88
103 124		40	110 172		48	111 006		44	111 211		70
103 125		42	110 175		50	111 007		46	111 212		88
103 128		34	110 176		50	111 010		52	111 213		88
103 137		38/92	110 178		51	111 010 az		52/64	111 214		88
103 143		34	110 179		50	111 011		52	111 215		88
103 146		40	110 180		48	111 011 az		52/64	111 216		88
103 147		40	110 181		51	111 012		52	111 217		88
103 148		40	110 182		50	111 013		52	111 222		49
103 150		34	110 183		50	111 015		54	111 222 G		49
103 158		42	110 187		50	111 015 az		54/64	111 225		49
103 168		36	110 188		48	111 015 ro		54/64	111 225 G		49
103 170		36	110 189		48	111 016		54	111 227		49
103 171		36	110 190		48	111 019		54	111 227 G		49
103 172		36	110 191		48	111 019 az		54/64	111 232		49
103 173		36	110 194		51	111 019 ro		54/64	111 232 G		49
103 174		36	110 195		51	111 020		54	111 235		49
103 174 S		36	110 196		50	111 023		55	111 235 G		49
103 180		36	110 197		50	111 023 az		55/64	111 237		49
103 181		36	110 198		50	111 023 ro		55/64	111 237 G		49
103 182		36	110 199		50	111 024		55	111 240	H	90
103 183		36	110 200		92	111 027		56	111 241	H	90
103 185		37	110 205		92	111 029		46	111 242	H	90
103 188		36/37/40	110 230		45/117	111 030		46	111 243	H	90
103 189		40	110 240		40	111 031		45	111 244	H	90
103 191	H	36	110 241		99/119	111 032		45	111 245	H	90
103 200		34	110 242		99/119	111 033		53	111 246	H	90
103 250		34	110 243		99/119	111 033 az		53/64	111 247	H	90
110 001		47	110 244		117	111 035		53	111 248	H	90
110 002		47	110 245		117	111 037		56	111 249	H	90
110 003		47	110 246		117	111 039		56	111 260		89
110 004		47	110 247		117	111 043		55	111 261	H	88
110 005		47	110 248		49	111 043 S		55	111 265		49
110 006		47	110 249		49	111 044		55	111 265 G		49
110 007		47	110 250		49	111 044 S		55	111 266		49
110 008		47	110 251		49	111 045		56	111 266 G		49
110 009		47	110 252		49	111 047		47	111 267		49
110 010		47	110 253		49	111 048		47	111 267 G		49
110 014		47	110 255		49	111 049		47	111 270	H	68/78
110 015		47	110 256		49	111 050		54	111 270 S	H	68/78
110 018	Ik 5,3 kA	101	110 257		49	111 051		54	111 271	H	68/78
110 019	Ik 12,3 kA	101	110 258		49	111 052		54	111 271 S	H	68/78
110 020	Ik 7,9 kA	101	110 265		50	111 057		55	111 272	H	68/78
110 021	Ik 7,0 kA	101	110 270		48	111 057 S		55	111 273	H	68/78
110 024	Ik 12,3 kA	101	110 271		48	111 058		55	111 274	H	68/78/82
110 026	Ik 5,3 kA	101	110 272		48	111 058 S		55	111 279	H	69
110 027	Ik 12,3 kA	101	110 276		48	111 060		180	111 280	H	69/94
110 029	Ik 7,9 kA	101	110 277		48	111 061		180	111 284		71
110 030		48	110 278		50	111 065	H	180	111 285		71
110 031		48	110 279		50	111 070		112	111 286		71
110 034		48	110 280		48	111 075		112	111 287		71
110 034 S3		48	110 281		48	111 076		112	111 296	H	37
110 035		48	110 282		50	111 080		116	111 297	H	37
110 038		48	110 283		50	111 081		116	111 298	H	37
110 038 S1		48	110 300		92	111 082		33/116	111 299	H	37
110 045		48	110 500		45	111 083		32/116	111 304		68
110 046		50	110 501		45	111 084		116	111 305		68
110 047		48	110 502		45	111 090		113	111 306		68
110 048		50	110 503		45	111 091		113	111 307		68
110 050		48	110 509		53	111 092		113	111 313	H	68/93
110 056		48	110 510		53	111 093		113	111 314	H	68
110 056 S3		48	110 511		53	111 094		113	111 315	H	68
110 069		48	110 512		53	111 095		113	111 317	H	68
110 071		48	110 515		56	111 096		113	111 319	H	68/93
110 072		48	110 517		52	111 097		113	111 330	H	99
110 073		50	110 518		52	111 098		113	111 331	H	99
110 075		50	110 519		52	111 099		113	111 332	H	99
110 076		50	110 520		58	111 100		88	111 333	H	99
110 077		51	110 521		58	111 120		88	111 334	H	99
110 078		51	110 522		58	111 132		58	111 337	H	76
110 080		45	110 523		58	111 133		58	111 339	H	76
110 081		45	110 524		59	111 134		58	111 340		40
110 087		50	110 525		59	111 135		58	111 341	H	76
110 090		44	110 526		59	111 136		58	111 344	H	76
110 090 S		44	110 527		59	111 136 az		58/64	111 345	H	76
110 091		44	110 528		59	111 136 ro		58/64	111 346		40
110 095		44	110 529		59	111 137		58	111 347		40
110 095 S		44	110 530		59	111 140		58	111 348		40
110 096		44	110 531		59	111 141		58	111 349		40
110 097		47	110 532		60	111 144		58	111 350		40
110 098		47	110 533		60	111 144 az		58/64	111 352	H	94
110 099		48	110 538		59	111 144 ro		58/64	111 353	H	94
110 100		92	110 539		59	111 145		58	111 354	H	94
110 120	Ik 4,2 kA	101	110 540		59	111 150		56	111 355	H	101
110 121	Ik 4,2 kA	101	110 541		59	111 153		56	111 356	H	101
110 122	Ik 4,2 kA	101	110 542		59	111 157		55	111 357	H	101
110 130		92	110 543		59	111 158		55	111 362		84

The components marked with -H- are tested with 100 kA (10/350 μ s) according to EN 62561-1. Status: December 2017
Ik = short circuit current (50Hz) (1s; \leq 300 C°)



Numerical index

Ord. no.	Tested	Page	Ord. no.	Tested	Page	Ord. no.	Tested	Page	Ord. no.	Tested	Page
111 363		84	111 491		123	111 677		73	111 807	H	97
111 364	H	84	111 492		123	111 678		73	111 808	H	97
111 365		84	111 493		123	111 679		73/83	111 809	H	97
111 366	H	84	111 494		123	111 680		78	111 810	H	97
111 370	H	71	111 495		123	111 681		78	111 816	H	97
111 371	H	71	111 496		122	111 682		78	111 817	H	97
111 375	H	74	111 497		122	111 683		78	111 818	H	97
111 376		80	111 501		45	111 684		78	111 819	H	97
111 379	H	80	111 502		45	111 685		80	111 820	H	97
111 380	H	80	111 503		45	111 686		80	111 870	H	79
111 381	H	80	111 504		45	111 687		80	111 871	H	79
111 382	H	80	111 505		45	111 688		80	111 872	H	79
111 384	H	81	111 506		45	111 689		80	111 873	H	79
111 385	H	81	111 507		45	111 690	H	95	111 874	H	81
111 386	H	81	111 508		45	111 691	H	95	111 875	H	81
111 387	H	81	111 509		45	111 692	H	95	111 876	H	81
111 388	H	81	111 510		45	111 693	H	95	111 877	H	81
111 389	H	81	111 511		53	111 694	H	95	111 878	H	81
111 390	H	89	111 511 az		53/64	111 695	H	95	111 879	H	81
111 391	H	89	111 512		53	111 696	H	95	111 880	H	79
111 392		89	111 513		53	111 697	H	95	111 881	H	79
111 393	H	89	111 516		53	111 698		100	111 882	H	79
111 394	H	89	111 525		52	111 699		100	111 883	H	79
111 395		89	111 525 az		52/64	111 700	H; lk 6,3 kA	75	111 884	H	81
111 396		49	111 525 ro		52/64	111 701	H; lk 3,3 kA	75	111 885	H	81
111 397		49	111 526		52	111 702	H; lk 6,3 kA	75	111 886	H	81
111 398		49	111 527		52	111 703	H; lk 3,3 kA	75	111 887	H	81
111 399		49	111 527 az		52/64	111 704	H; lk 3,3 kA	75	111 888	H	81
111 400	H	108	111 527 ro		52/64	111 705	H; lk 3,3 kA	75	111 889	H	81
111 402	H	85	111 528		52	111 710	H	77	112 000	H; lk 3,3 kA	103
111 403	H	85	111 530		55	111 711	H	77	112 002	H; lk 7,3 kA	104
111 404	H	85	111 530 az		55/64	111 712	H	77	112 003	H; lk 3,1 kA	106
111 405	H	74	111 530 ro		55/64	111 713	H	77	112 004	H; lk 5,0 kA	103
111 406	H	98	111 532		55	111 714	H	77	112 005	H; lk 3,9 kA	108
111 407	H	98	111 535		54	111 715	H	77	112 007	H; lk 6,2 kA	103
111 408	H	98	111 536		54	111 716	H	77	112 008	H; lk 8,0 kA	104
111 409	H	98	111 537		54	111 717	H	77	112 009	H; lk 2,2 kA	106
111 410	H	42/70	111 540		54	111 718	H	77	112 010	H; lk 3,1 kA	105
111 411	H	42/70	111 540 az		54/64	111 719	H	77	112 011	H; lk 3,1 kA	105
111 412	H	42/70	111 540 ro		54/64	111 720	H	77	112 012	H; lk 3,1 kA	105
111 413	H	98	111 541		54	111 721	H	77	112 013	H; lk 3,1 kA	105
111 414	H	98	111 541 az		54/64	111 722	H	77	112 017	H; lk 3,9 kA	108
111 416	H	98	111 541 ro		54/64	111 723	H	77	112 018	H; lk 3,9 kA	108
111 417	H	98	111 545		54	111 724	H	77	112 020	H; lk 3,3 kA	104
111 420	H	98	111 546		54	111 725	H	77	112 021	H; lk 3,3 kA	104
111 420 S2	H	98	111 550		53	111 726	H	77/82	112 022	H; lk 6,2 kA	104
111 421	H	98	111 551		53	111 727	H	77/82	112 023	H; lk 5,0 kA	104
111 421 S2	H	98	111 552		53	111 728	H	77/82	112 024	H; lk 8,0 kA	104
111 423	H	99	111 553		53	111 729	H	77/82	112 025	H; lk 7,3 kA	104
111 423 S	H	99	111 580	H	87	111 730		61	112 027	H	107
111 424	H	99	111 582		86	111 731		61	112 039	H; lk 3,9 kA	108
111 424 S	H	99	111 585		87	111 734	H	81	112 040		106
111 424 S1	H	99	111 587	H	87	111 735	H	81	112 041		106
111 424 S2	H	99	111 588		87	111 736	H	81	112 042		106
111 425	H	94	111 590		112	111 737	H	81	112 043	H	108
111 426	H	94	111 598		60	111 738	H	81	112 044	H	108
111 430	H	43/69/126	111 600		61	111 739	H	81	112 045	H; lk 7,3 kA	108
111 430 S	H	126	111 604		60	111 740	H; lk 7,4 kA	75	112 046	H; lk 7,3 kA	108
111 430 S3	H	127/151	111 620		86	111 741	H; lk 3,9 kA	75	112 047		108
111 432	H	42/69	111 623		86	111 742	H; lk 7,4 kA	75	112 048		108
111 433	H	42/69	111 624		86	111 743	H; lk 3,9 kA	75	112 049		108
111 440		89	111 625		86	111 744	H; lk 3,9 kA	75	112 050		108
111 441		89	111 626		86	111 745	H; lk 3,9 kA	75	112 051		108
111 442		89	111 627		86	111 750		57	112 052		108
111 445	H	102	111 628		86	111 750 S		57	112 053	H; lk 3,9 kA	108
111 445 S	H	102	111 629		86	111 760		57	112 054	H; lk 3,9 kA	108
111 446		118	111 630		61	111 761		57	112 082	H; lk 7,3 kA	113
111 448	H	102	111 631		60	111 764		57	112 100	H; lk 3,3 kA	106
111 449		89	111 632		60	111 765		57	112 113	H; lk 4,3 kA	105
111 451		56	111 633		61	111 766		57	112 114	H; lk 4,3 kA	105
111 452		56	111 635		60	111 767		57	112 115	H; lk 4,3 kA	105
111 453		56	111 638		86	111 768		57	112 116	H; lk 4,3 kA	105
111 454		56	111 639		86	111 769		57	112 117	H; lk 4,3 kA	105
111 455		56	111 640		86	111 779	H	80	112 118	H; lk 4,3 kA	105
111 458		102	111 641		86	111 780		79/113	112 119	H; lk 4,3 kA	105
111 460		102	111 645		60/155	111 781		79/113	112 130	H; lk 4,3 kA	105
111 461		102	111 650		88	111 782		79/113	112 140	H; lk 3,3 kA	106
111 462		102	111 651		88	111 784	H	81	112 141	H; lk 3,3 kA	106
111 463		102	111 652		88	111 785	H	81	112 150 (M10)	H; lk 4,3 kA	103
111 464		102	111 653		88	111 786	H	81	112 150 (M12)	H; lk 3,8 kA	103
111 465		102	111 654		88	111 787	H	81	112 151 (M10)	H; lk 6,5 kA	103
111 466		102	111 655		88	111 788	H	81	112 151 (M12)	H; lk 6,3 kA	103
111 467		102	111 656		88	111 789	H	81	112 152 (M10)	H; lk 5,1 kA	103
111 468		102	111 660		61	111 790	H	95	112 152 (M12)	H; lk 4,9 kA	103
111 479		102	111 661		60	111 791	H	95	112 153	H; lk 6,4 kA	103
111 479 S		102	111 662		60	111 792	H	95	112 154	H; lk 10,5 kA	104
111 479 S1		102	111 663		61	111 793	H	95	112 155	H; lk 11,0 kA	103
111 480		62	111 666		79	111 794	H	95	112 156	H; lk 5,6 kA	105
111 481		62	111 667		79	111 795	H	95	112 157	H; lk 5,6 kA	105
111 482		62	111 669		79	111 796	H	96	112 158	H; lk 5,6 kA	105
111 483		62	111 670		73	111 797	H	96	112 159	H; lk 5,6 kA	105
111 484		62	111 671		73	111 798		96	112 160	H; lk 6,5 kA	105
111 485		62	111 672		73	111 799		96	112 161	H; lk 6,5 kA	105
111 486		62	111 673		73	111 800	H	96	112 162	H; lk 6,5 kA	105
111 487		62	111 674		73/83	111 802	H	96	112 163	H; lk 6,5 kA	105
111 488		62	111 675		73	111 804	H	96	112 164	H; lk 6,5 kA	105
111 490		123	111 676		73	111 806	H	97	112 165	H; lk 6,5 kA	105

The components marked with -H- are tested with 100 kA (10/350 μ s) according to EN 62561-1. Status: December 2017
lk = short circuit current (50Hz) (1s; \leq 300 C°)

Numerical index

Ord. no.	Tested	Page	Ord. no.	Tested	Page	Ord. no.	Tested	Page	Ord. no.	Tested	Page
112 166	H; lk 6,5 kA	105	210 202		179	306 762		173	317 765		169
112 167	H; lk 6,5 kA	105	210 210		179	306 766		173	317 766		168
112 170	H; lk 10,5 kA	105	210 212		179	306 782		173	317 781		169
112 171	H; lk 10,5 kA	105	210 222		179	306 786		173	317 782		168
112 172	H; lk 10,5 kA	105	210 228		179	306 792		173	317 785		169
112 173	H; lk 10,5 kA	105	220 000		176	306 796		173	317 786		168
112 174	H; lk 10,5 kA	105	220 105		175	307 200		161	317 792		168
112 175	H; lk 10,5 kA	105	220 112		175	307 201		181	317 796		168
112 176	H; lk 10,5 kA	105	220 124		175	307 201 PV		181	327 201		181
112 177	H; lk 10,5 kA	105	220 148		175	307 202		161	327 210		159
112 180	H; lk 10,5 kA	106	220 160		175	307 203		181	327 212		159
112 181	H; lk 10,5 kA	106	220 194		175	307 203 PV		181	327 220		159
112 182	H; lk 10,5 kA	106	220 205		176	307 210		161	327 222		159
112 183	H; lk 10,5 kA	106	220 212		176	307 212		161	327 230		159
112 200	H; lk 3,3 kA	103	220 224		176	307 220		161	327 232		159
112 202	H; lk 7,3 kA	104	220 248		176	307 222		161	327 240		159
112 203	H; lk 3,1 kA	106	220 260		176	307 230		161	327 242		159
112 204	H; lk 5,0 kA	103	220 500		176	307 232		161	327 250		159
112 207	H; lk 6,2 kA	103	220 605		175	307 240		161	327 252		159
112 208	H; lk 8,0 kA	104	220 612		175	307 242		161	410 000		110
112 209	H; lk 2,2 kA	106	220 624		175	307 250		161	416 000		110
112 220	H; lk 3,3 kA	104	220 648		175	307 252		161	490 000		129
112 221	H; lk 3,3 kA	104	220 660		175	307 260		161	490 001		129
112 222	H; lk 6,2 kA	104	220 694		175	307 301		181	490 002		129
112 223	H; lk 5,0 kA	104	220 705		176	307 301 PV		181	490 003		129
112 224	H; lk 8,0 kA	104	220 712		176	307 303		181	490 004		129
112 225	H; lk 7,3 kA	104	220 724		176	307 303 PV		181	490 005		129
112 300	H; lk 3,3 kA	106	220 748		176	307 401		181	490 007		129
112 313	H; lk 4,3 kA	105	220 760		176	307 401 PV		181	490 008		129
112 314	H; lk 4,3 kA	105	230 105		174	307 403		181	490 300		128
112 315	H; lk 4,3 kA	105	230 124		174	307 403 PV		181	490 301		128
112 316	H; lk 4,3 kA	105	230 605		174	307 762		170	490 302		128
112 317	H; lk 4,3 kA	105	230 624		174	307 766		170	490 405 V		123
112 318	H; lk 4,3 kA	105	240 100		178	307 782		170	490 408 V		123
112 319	H; lk 4,3 kA	105	240 190		178	307 786		170	490 410 V		123
112 330	H; lk 4,3 kA	105	240 200		178	307 792		170	490 430		124
112 340	H; lk 3,3 kA	106	240 250		178	307 796		170	490 431		124
112 341	H; lk 3,3 kA	106	240 300		178	316 220		164	490 432		124
113 029	H	110	240 309		178	316 221		164	490 433		124
113 030	H	110	240 350		178	316 222		164	490 433 S		124
113 085	H	109	240 351		178	316 223		164	490 443		124
113 088	H	109	240 352		178	316 224		164	490 444		124
113 105	H	109	240 353		178	316 225		164	490 450		125
113 108	H	109	240 451		178	316 226		164	490 451		125
113 123	H	109	298 900	H	88	316 227		164	490 452		125
113 125	H	109	306 050		158	316 228		164	490 490		123
113 133	H	109	306 051		158	316 229		164	490 491		123
113 135	H	109	306 052		158	316 280		163	490 492		123
113 216	H	110	306 075		163	316 281		181	490 495		123
113 219	H	110	306 076		163	316 281 PV		181	490 505		125
113 231	lk 8.5 kA	32	306 078		163	316 282		163	490 506		125
113 260	H	109	306 100		158	316 286		163	490 507		125
113 270	H	109	306 101		158	316 364		181	490 508		125
113 290	H	109	306 220		165	316 364 PV		181	490 513		124
113 300	H	109	306 221		165	316 442		181	490 514		124
114 400	H	109	306 222		165	316 442 PV		181	490 515		124
114 500	H	109	306 223		165	316 701		172	490 530		125
114 550	H	109	306 224		165	316 705		172	490 531		125
114 650	H	109	306 225		165	316 761		172	490 532		125
114 700	H	109	306 226		165	316 762		171	490 535		125
114 800	H	109	306 227		165	316 765		172	490 536		125
114 850	H	109	306 228		165	316 766		171	490 548		134/147
114 950	H	109	306 229		165	316 781		172	490 549		134/147
206 004		180	306 280		163	316 782		171	490 550		134/147
206 005		180	306 281		181	316 785		172	490 551		134/147
206 010		180	306 281 PV		181	316 786		171	490 552		134/147
206 011		180	306 282		163	316 792		171	490 553		134/147
206 060		180	306 283		181	316 796		171	490 560		134/147
206 062		180	306 283 PV		181	317 200		160	490 561		134/147
206 063		180	306 285		163	317 201		181	490 562		134/147
206 064		180	306 286		163	317 201 PV		181	490 563		134/147
206 065		180	306 330		167	317 202		160	490 570		134/147
206 281		181	306 331		167	317 206		181	490 571		134/147
206 283		181	306 332		167	317 210		160	490 572		134/147
206 300		166	306 360		163	317 212		160	490 573		134/147
206 301		166	306 361		163	317 220		160	490 580		126/150
206 303		166	306 364		181	317 222		160	490 581		126
206 304		166	306 364 PV		181	317 230		160	490 581 S1		126
206 306		166	306 365		163	317 232		160	490 581 S2		126
206 307		166	306 366		181	317 235		162	490 581 S3		126
206 312		167	306 366 PV		181	317 237		162	490 581 S4		126
206 364		181	306 420		166	317 240		160	490 582		127/151
206 366		181	306 430		166	317 242		160	490 584		127/151
206 442		181	306 440		166	317 245		162	490 585		127/151
206 444		181	306 441		163	317 247		162	490 586		127/151
207 000		180	306 442		181	317 250		160	490 587		127/151
207 201		181	306 442 PV		181	317 252		160	490 587 S		127/151
207 203		181	306 443		163	317 255		162	490 588		127/151
207 301		181	306 444		181	317 257		162	490 588 S		127/151
207 303		181	306 444 PV		181	317 260		160	490 589		127/151
207 401		181	306 450		166	317 262		160	490 590		127/151
207 403		181	306 460		166	317 301 PV		181	490 591		127/151
210 012		177	306 500		163	317 405 PV		181	490 591 S		127/151
210 100		177	306 501		163	317 701		169	490 592		127/151
210 110		177	306 503		163	317 705		169	490 592 S		127/151
210 130		177	306 602		163	317 761		169	490 593		127/151
210 200		179	306 604		163	317 762		168	490 593 S		127/151

The components marked with -H- are tested with 100 kA (10/350 μ s) according to EN 62561-1. Status: December 2017
lk = short circuit current (50Hz) (1s; \leq 300 C°)



Numerical index

Ord. no.	Tested	Page
490 594		127/151
490 620		128
490 621		128
490 622		128
490 623		128
490 624		128
490 625		128
490 700		128
490 701		128
490 702		128
490 703		128
499 000		122/132
499 005		133
499 006		133
499 007		133
499 009		133
499 010		122/132
499 100		132
499 101		132
499 500		133
499 600		133
499 700		122/132
600 001		144
600 002		144
600 003		144
600 501		156
600 502		156
600 503		156
600 504		156
600 505		156
600 510		156
600 520		156
600 530		156
600 540		156
600 550		156
601 100		144
601 100-5		145
601 100-xx		145
601 101		144
601 101-5		145
601 101-xx		145
601 102		144
601 102-5		145
601 102-xx		145
601 110		144/145
601 111		144
601 112		145
601 113		145
601 200		145
612 001		148
612 002		148
612 003		148
612 010		153
612 011		153
612 020		153
612 021		153
612 022		153
612 030		153
612 031		153
612 040		153
612 041		153
612 050	H	154
612 051	H	154
612 060		149
612 070		149
612 080		149
612 081		149
612 082		149
613 020		153
613 021		153
613 022		153
613 030		153
613 031		153
614 001		148
614 003		148
614 010		153
614 011		153
614 060		149
614 070		149
622 000		149
622 001		149
622 005		150
624 000		149
624 001		149
624 005		150
624 010		152
624 011		152
624 020		152
624 021		152
624 022		152
632 000		146
632 001		146
632 002		146
632 003		146
632 004		146
632 005		146
632 200		147

Ord. no.	Tested	Page
632 201		147
632 202		147
632 203		147
632 204		147
632 205		147
632 400		155
640 000		155
640 001		155
640 002		155
640 003		155
640 004		155
640 005		155
640 006		155
640 007		155
640 010		155
640 020		155
640 050		154
900 047	H	100
910 007	H	100
910 009	H; lk 39,0 kA	113
910 010	H; lk 39,0 kA	113
910 011	H; lk 7,3 kA	113
910 012	H; lk 7,3 kA	113
910 013	H; lk 7,3 kA	113
910 018	H; lk 7,3 kA	113
910 019	H; lk 7,3 kA	113
910 020	H; lk 7,3 kA	113
910 022	H; lk 7,3 kA	113
910 023	H	114
910 095	lk 4,2 kA	101
910 096	H	85
910 096 S	H	85
910 097		61
910 101	H	69
910 105		78
910 107	H	69
910 139	H; lk 39,0 kA	113
910 183		72
910 193	H; lk 39,0 kA	113
910 223	H	114
910 242		38
910 243		38
910 247	H	38
910 248	H	38
910 257	H	38
910 258	H	38
910 259	H	100
910 260	H	100
910 286	H	90
910 301	H	114
910 302	H; lk 7,3 kA	113
910 305	H	114
910 306	H	114
910 307	H	114
910 308	H	114
910 309	H	114
910 330	H	114
910 331	H	114
910 332	H	114
910 333	H	114
910 347		38/92
910 359	H; lk 39,0 kA	113
910 375	H; lk 39,0 kA	113
910 380	H	114
910 382	H; lk 39,0 kA	113
910 385	H; lk 7,3 kA	113
910 494	H	100
910 527	H; lk 39,0 kA	113
910 540	H; lk 39,0 kA	113
910 544	H	114
910 545	H	114
910 572	H	90
910 579	H	76
911 178		85
911 224	H	69
911 280		49
911 280 S		49
911 314		51
911 575		51
911 576		51
911 654		49
911 654 S		49
911 688	H	85
912 000		132
912 000 W		134
912 001		132
912 001 W		134
912 002		132
912 002 W		134
912 003		132
912 003 W		134
912 004		132
912 004 W		134
912 005		132
912 005 W		134
912 006		132
912 006 W		134

Ord. no.	Tested	Page
912 007		132
912 007 W		134
912 008		132
912 008 W		134
912 009		132
912 009 W		134
912 010		132
912 010 W		134
912 011		132
912 011 W		134
912 013		132
912 013 W		134
912 015		132
912 015 W		134
912 019		132
912 019 W		134
912 120		139
912 121		139
912 122		139
912 125		93
912 150		138
912 155		138
912 160		138
912 165		138
912 200		137
912 201		137
912 202		137
912 203		137
912 204		137
912 205		137
912 206		137
912 207		137
912 208		137
912 400		35/135
912 401		35/135
912 402		35/135
912 403		35/135
912 500		132
912 501		132
912 502		132
912 600		35/135
912 601		35/135
912 602		35/135
912 603		35/135
913 420		53
913 610		49
913 611		49
913 615		57
913 616		57
913 617		57
913 650	H	114
913 651	H	114
913 652	H	114
913 653	H	114
913 654	H	114
913 655	H	114
913 656	H	114
913 657	H	114
913 658	H	114
913 660	H	114
913 661	H	114
913 662	H	114
913 666	H	114
913 667	H	114
913 668	H	114
913 732		53
913 733		53
913 734		53
913 825		89/127/151
913 831		89/127/151
914 077		128
919 860		39
919 860 S		39
919 860 S1		39
920 181	H	38
920 181 S	H	38
920 700		136
920 701		136
920 702		136
920 703		136
920 704		136
920 705		136
920 706		136
920 707		136
920 708		136
920 709		136
920 710		136
920 711		136
920 860		39
920 860 B		39
T 14 A 0001 A		110
T 14 B 0001 A		110
T 14 B 0002 A		110

The components marked with -H- are tested with 100 kA (10/350 μ s) according to EN 62561-1. Status: December 2017

lk = short circuit current (50Hz) (1s; \leq 300 C°)





Factories and distribution centres:

Factory I:

J. Pröpster GmbH
Regensburger Str. 116
D-92318 Neumarkt/OPf.
Germany
Phone +49 9181 2590-0
Fax +49 9181 2590-10
Email: info@proepster.de

Factory II:

J. Pröpster GmbH
Lerchenstraße 48
D-09669 Frankenberg
Germany
Phone +49 37206 2592
Fax +49 37206 2821

Factory III:

J. Pröpster GmbH
Gewerbepark C1
D-92364 Deining
Germany

Distribution centre:

Thomas Rettig
Schönefelder Weg 2
D-06895 Zahna-Elste
Germany
Phone +49 34924 7000
Fax +49 34924 70011
Email: info@rettig-proepster.de



International representatives:

Hungary

REX - Elektró Kft.
Phone +36 138 885 47
info@proepster.hu

Belgium

NBR Nussbaumer nv/sa
Phone +32 23 57 09 40
info@nussbaumer.be

Netherlands

Alhadra B.V.
Phone +31 174 386 641
alhadra@planet.nl

Italy

Konrad Stauder
Phone +39 0471 622 655
konrad.stauder@rolmail.net

Latvia

Baltic Lightning Protection Ltd.
Phone +371 295 557 95
ervins.elksnis@blp.lv

Switzerland

Vontobel Verbindungstechnik
Phone +41 554 517 570
info@vvtechnik.ch

Bulgaria

Blitz Guard LTD
Phone +35 929 63 13 22
blitzguard@techno-link.com

Estonia

Baltic Lightning Protection Ltd.
Phone +371 295 557 95
ervins.elksnis@blp.lv

Greece

Technical Development LTD
Phone +30 210 578 2008
info@technical-development.gr

Czech Republic

Hromosvodní technika M.P., s.r.o.
Phone +420 603 816 081
proepster@proepster.cz

Lithuania

Baltic Lightning Protection Ltd.
Phone +371 295 557 95
ervins.elksnis@blp.lv

Russia

Baltic Lightning Protection Ltd.
Phone +371 295 557 95
ervins.elksnis@blp.lv

Croatia

EIT Elektroinstalacijska tehnika d.o.o.
Phone +385 1 3498 100
eit@eit.hr

Bosnia-Herzegovina

EIT Elektroinstalacijska tehnika d.o.o.
Phone +385 1 3498 100
eit@eit.hr

Slovenia

EIT Elektroinstalacijska tehnika d.o.o.
Phone +385 1 3498 100
eit@eit.hr

Serbia

EIT Elektroinstalacijska tehnika d.o.o.
Phone +385 1 3498 100
eit@eit.hr

Sweden

AB ELROND Komponent AB
Phone +46 844 980 80
info@elrond.se

Denmark

Dan Delektron A/S
Phone +45 701 088 88
mail@dandel.dk

Columbia

POWERCOL S.A.S.
Phone +57 153 33 122
gerencia@powercol.com

Lebanon

Polaris Automation Systems SARL
Phone +961 9 853 639
polaris@polarisleb.com

Ukraine

Baltic Lightning Protection Ltd.
Phone +371 295 557 95
ervins.elksnis@blp.lv

Albania

Bliz Guard d.o.o.e.l.
Phone +389 76 200 458
skopje@blitzguard.com

Macedonia

Bliz Guard d.o.o.e.l.
Phone +389 76 200 458
skopje@blitzguard.com

Kosovo

Bliz Guard d.o.o.e.l.
Phone +389 76 200 458
skopje@blitzguard.com

Belarus

Baltic Lightning Protection Ltd.
Phone +371 295 557 95
ervins.elksnis@blp.lv

South Africa

H.H.K. Earthing & Lightning Protection
Phone +27 11 476 6917
info@hbk.co.za

Namibia

H.H.K. Earthing & Lightning Protection
Phone +264 61 308 935
hbknam@iway.na

Botswana

H.H.K. Earthing & Lightning Protection
Phone +267 397 3000
info@hbk.co.za

TERMS OF SALE AND DELIVERY

for commercial business transactions

THIS IS AN ENGLISH TRANSLATION FOR INFORMATION PURPOSES ONLY. FOR ALL LEGAL PURPOSES REFERENCE SHOULD BE MADE TO THE GERMAN ORIGINAL

1. General:

All deliveries are subject to our terms, even if the customer specifies different terms. Any arrangements that have not been included in the confirmed order or that have not been confirmed by us in writing, are non-binding.

On publishing the main catalogue 2018 all previously existing prices and price agreements lose their validity.

2. Quotation:

If not arranged otherwise, our quotations are non-binding and without engagement.

We do not accept any responsibility or liability whatsoever for the functionality of products manufactured according to the customer's drawings or for any other defects which may occur as a result of the customer's instructions. Documents, such as diagrams, drawings, information about weight and dimensions of products represent approximations only; unless such information is described as "binding". We reserve the copyright for all cost estimates, drawings and other documents. Any such documents become our property and may not be disclosed to third parties. Any infringements are liable for full damages. In case of infringement, we also reserve the right to withdraw immediately from a contract. Constructional designs are also subject to change. Drawings and other documents included in our bids must be returned to us or remunerated on request or, if we have not been granted the contract, immediately. The amount payable will be determined by us based on economic factors at our reasonable discretion.

3. Order – Completion of the contract:

Orders are not valid until they have been confirmed by us in writing. A commercial invoice may also serve as order confirmation.

4. Prices

All prices are in EURO excluding sales tax. Unless otherwise agreed, prices are stated ex works, including standard packaging. Sales tax will be calculated based on the valid rate on the day of delivery. Any discounts will be deducted from the list prices. We reserve the right to re-calculate the prices for products or energy costs that are associated with an official authorization, if the official authorization takes effect in the time between contracting and product delivery. Additionally, we also reserve the right for a re-calculation, if collectively agreed upon wage and salary increases have taken effect in the time between contracting and product delivery. The prices listed for components made of copper, brass or red brass are based on a DEL copper quote of 153.39 EUROS. Should the DEL quote increase by more than 12.78 EUROS per 100 kg, we will charge an additional non-ferrous metal fee. The price calculation is based on the DEL quote on the day after receipt of the clarified order. If one of our cost price factors is excluded from the price fixing process and a traceable cost price factor arises subsequently, we will be authorized to re-calculate the price, if the price increase occurs in the time between contracting and product delivery. The prices listed are non-binding, recommended prices. Our products may be resold at a higher or lower price by our customers.

5. Terms of payment

Unless otherwise agreed in writing, all payments must be made either within 8 days after invoice date with a 2% cash discount or in full within 30 days after invoice date. Payment is automatically considered overdue the day after these appointed payment dates have expired. A payment reminder to establish the debt is not required.

We reserve the right to appropriate any payments made first to the cost, then to the interest and thereafter to the oldest, still outstanding invoices, even if the customer makes different stipulations at the time of making a payment. If, after conclusion of the contract, it comes to our notice through our enquiries and other facts that it is, at our discretion, not advisable to allow the customer credit to the amount of the invoice we will be entitled to ask for advance payments, security for all deliveries or to withdraw from the contract. If advanced payments or security deposits are not made within the time period stipulated by us, we are entitled to claim damages due to default. If the customer falls behind with making partial or full payment, all of our payment claims become due immediately.

The customer has no right to retain or reject the services owed to him. From the due date of the payment, the customer will be charged with interest on arrears which is 2% higher than the interest normally charged by our bank. For orders with a net value (value of items without shipping costs and sales tax) of less than EURO 40.00, an extra charge of EURO 5.00 for small quantities will be invoiced. Cash sales are excluded.

6. Reservation of title

We reserve the right of ownership in respect of the goods supplied until such time as all claims under the business relationship with the partner have been met. The customer's claims from the resale of the reserved goods and/or further manufacturing steps involving the use of our goods are fully transferred to us. Passing on our goods is only permitted within the context of proper business operations. In the event that the customer sells or delivers the reserved goods, with or without further processing, together with other goods that are not our property, then the assignment of the accounts receivable resulting from the resale only applies to the value of the reserved goods. The customer has no other rights of disposal concerning the reserved goods. At our request the customer is obliged to inform us about his customer and the agreed selling price and to inform his customer of any assignment to us.

7. Delivery

The agreed delivery times commence on the day on which the contract becomes legally effective. Unforeseen events, such as war, mobilization, natural phenomena, disturbances of normal factory operations which are beyond our control, delayed delivery or quality defects of raw materials, etc., damage to important workpieces, or difficulties of various kinds due to unstable economic conditions, entitle us to extend the delivery time by the time required to deal with these events. We are also entitled to withdraw from the contract if any such events occur, even if the delivery time has already been extended. Such circumstances neither entitle the customer to withdraw from the contract nor to claim damages.

8. Shipping

The delivery is considered to have been effected as soon as the goods have left the factory or the warehouse, even if delivery carriage paid has been arranged. Upon request by and at the expense of the customer, we can insure the consignment against breakage, fire and transport damage.

9. Warranty and liability

The customer or his representative must inform us immediately on receipt of the goods in writing about any immediately apparent defects and any latent defects which are discovered upon careful inspection of the goods delivered, including incomplete delivery. We are entitled to take back faulty goods, to issue a credit note or to replace with faultless goods, if the defect has been claimed immediately. This also applies to defects that were not recognized during the immediate entry inspection. We shall not assume liability for any damage caused by incorrect installation or modifications made to the product. Further claims by the customer, such as redhibitory action, reduction of the purchasing price, compensation, as well as claims brought forth by third parties are excluded. We are not liable for any damage not deriving from the delivered goods themselves. In particular, we are not liable for lost profit or other financial losses incurred by the customer. The aforementioned limitations of liability do not apply in the case of specific intent or gross negligence. They also do not apply if the customer has claimed damages due to default because the product is lacking an advertised property according to §§ 463, 480 II BGB (German Civil Code). Compensation is limited to foreseeable damage. In the event that we violate a cardinal duty or a contractual obligation through negligence or we are responsible for a culpa in contrahendo we are liable only for standard contractual loss or loss which might reasonably have been expected.

We deliver only functional goods. A warranty for using the goods for the purpose intended by the customer can only be given, if we have issued our express written consent.

So far as our liability for damages is excluded or limited, it can also be applied to any other claims, including claims due to culpa in contrahendo, infringement of minor obligations and claims arising from the producer's liability according to § 823 BGB (German Civil Code).

The above paragraph does not apply to claims according to §§ 1, 4 of the Produkthaftungsgesetz (German Product Liability Law) or in cases of inability or impossibility.

So far as our liability is excluded or limited this also applies to the personal liability of our employees, representatives, deputies and assistants.

Any liability claims cease in agreement with § 477 BGB (German Civil Code), excluding claims arising from the producer's liability according to §§ 823 cont. BGB (German Civil Code).

10. Returning material

Delivered products can only be returned in exceptional cases and only with our approval. The goods must be in their original packaging. Goods which were delivered more than 3 months ago cannot be returned.

In order to cover the costs of handling returned goods, we charge a return fee amounting to 10% of the goods' net value. If, for special reasons, we agree to take back unpacked parts or parts that are not in their original packaging, a fee for new packaging amounting to 10% will be added to the return fee. Transport costs for returned goods will not be paid by us.

11. Data privacy

The customer's data concerning our business relationship with him will be handled according to the German Federal Data Protection Law.

12. Place of fulfilment, place of jurisdiction

German law is applicable to these terms of sale and delivery and to the entire legal relationship between the contractual partners. The UN Convention on Contracts for the International Sale of Goods (CISG) from 04/11/1980 is not applicable.

Place of fulfilment and jurisdiction for delivery, payment and all liabilities, including any action relating to payment by bill of exchange or cheque, is the town of Neu-markt/Opf. Invalidity of one part of these terms of delivery does not affect the other parts of this agreement. In this case, the invalid part is replaced by the current legal regulation. Any changes or alterations to these terms of delivery require the written consent of the seller.

Sales tax identification no.: DE 133211151 J. Pröpster GmbH.

Register of companies Nuremberg, HRB 8169,

Managing directors: Johann Pröpster; Prof. Dr. h.c. Dipl. Ing. Johann Pröpster



Surge Protection



Insulated lightning protection



HVC-Conductor



35 years J. Pröpster

J. Pröpster GmbH Specialist manufacturer of lightning protection and earthing materials

Factory I:

Regensburger Str. 116
D-92318 Neumarkt/OPf.
Germany
Phone +49 9181 2590-0
Fax +49 9181 2590-10
Email: info@proepster.de
Internet: www.proepster.de

Factory II:

Lerchenstraße 48
D-09669 Frankenberg
Germany
Phone +49 37206 2592
Fax +49 37206 2821
Email: info@proepster.de
Internet: www.proepster.de

Factory III:

Gewerbepark C1
D-92364 Deining
Germany
Phone +49 9181 2590-0
Fax +49 9181 2590-10
Email: info@proepster.de
Internet: www.proepster.de